



CHAPTER 5

ELECTRIC SERVICE RULES – DISTRIBUTED GENERATION

500. SCOPE

This chapter includes distributed or customer-owned generation connected in parallel and operating with Alliant Energy's electric distribution system.

For all Distributed Generation (DG) installations, please contact Alliant Energy's Renewable Hotline at 1-800-972-5325 or by email at sellmypower@alliantenergy.com. Customers may also visit alliantenergy.com/sellmypower.

501. AVAILABILITY

DG is available for single and three phase customers where a part or all of the electrical requirements of the customer are supplied by the customer's generating facilities. Characteristics of Alliant Energy's electrical system vary by circuit. Not every size, voltage and "phase" generator can be connected at every location.

502. PERMMISION TO CONNECT

The customer shall consult Alliant Energy prior to the installation of a parallel generator and supply the Alliant Energy with the required electrical drawings and data for the proposed installation. Alliant Energy's permission is required for each installation and such permission granted shall not constitute a guarantee or imply Alliant Energy's liability for satisfactory operation of the customer's generator. Alliant Energy may specify and require certain protective schemes based on the size, location and other factors of the generating unit proposed.

503. ELECTRIC RATE

Customer-generated electricity delivered to Alliant Energy's system will be purchased in accordance with applicable tariffs and rates.

504. METERING

- A. Alliant Energy will furnish and install appropriate meters, (CTs and PTs, if required) to measure energy flow. Note that additional meter charges may apply.
- B. The customer shall furnish, install, own and maintain the necessary electric service entrance equipment, meter sockets, metering cabinets and related equipment that may be required for supporting or enclosing Alliant Energy's metering equipment.

505. COMPANY DISTRIBUTION SYSTEM

Modifications and additions to Alliant Energy's electrical distribution system to accommodate distributed generation systems are treated as standby or duplicate facilities according to Alliant Energy's extension rules.

506. TECHNICAL INFORMATION**IOWA**

- IPL Technical Guidelines and Requirements for Interconnection of Parallel Operated Generation Connected to the Interstate Power and Light Electric Distribution System
- The Iowa Administrative Code Chapter 45

WISCONSIN

- WPL Technical Guidelines and Requirements for Interconnection of Parallel Operated Generation Connected to the Wisconsin Power and Light Electrical Distribution System
- PSC 119 – Rules For Interconnecting Distributed Generation Facilities
- Standard Distributed Generation Application Form (Generation 20 kW or Less)
- Standard Distributed Generation Application Form (Generation 20 kW to 15 MW)
- Distributed Generation Interconnect Agreement (20 kW or less)
- Distributed Generation Interconnect Agreement (20 kW to 15 MW)

507. CONTRACT

Alliant Energy will require an interconnect agreement specifying technical and operating aspects of distributed generation.

508. INSURANCE (See Standard Interconnection Agreement)

509. GENERATOR OPERATION (See Standard Interconnection Agreement)

510. GENERATOR MAINTENANCE (See Standard Interconnection Agreement)

511. GENERATOR PROTECTION (See Standard Interconnection Agreement)

512. ISOLATION

The customer shall provide an isolating device to automatically disconnect the customer's generator from Alliant Energy's electrical system in the event of a power outage. The isolating device shall not re-close until after power is restored to Alliant Energy's electrical system. The isolating device may be a circuit breaker, relay contacts, switch or equivalent equipment. The above isolating device shall be activated by reliable sensors that detect loss of utility system AC voltage, low or high frequency, generator overload or other suitable input from Alliant Energy's distribution system.

Static Inverters and Converters shall have a UL 1741 listing or accepted Nationally Recognized Testing Laboratories (NRTL) with an Output Type of "Utility Interactive" or an Output Code of "UI" (See Technical Guidelines and Distributed Generation Requirements).

513. SYNCHRONIZING - (see Technical Guidelines referred to in Section 506)

514. TRANSFORMATION

In the event the voltage or frequency supplied by the customer's generator is different than Alliant Energy's available standard frequency and or voltage (refer to Chapter 1, Section 108), the customer shall install, own and maintain all transformers and associated equipment necessary for the voltage transformation.

515. POWER FACTOR AND CAPACITORS

Some types of generators cannot supply the customer's lagging power factor loads such as motors, etc. The customer is responsible for supplying any power factor correction, such as capacitors, which may be required during the generator operation.

The power factor of a generator shall not be less than required. The customer is responsible for providing power factor correction for generation below the requirement value (see Technical Guidelines and Distributed Generation Contract Requirements).

516. OPTIONAL STANDBY GENERATOR USED WITH PARALLEL GENERATION

Where a customer operates both a parallel generator and an optional standby generator, the standby generator must be installed in accordance with the connection and transfer switch requirements of ESR Chapter 12.

517. ADDITIONAL REQUIREMENTS

- A. Permanent labeling is required; Labeling shall be rigid engraved plastic or an approved engraved self-sticking brass or aluminum. All labels must be easily readable from a distance.

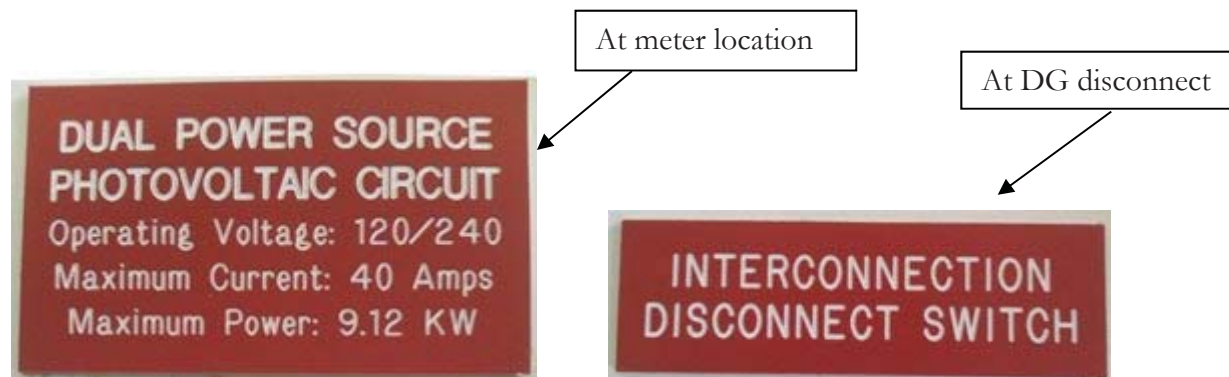

- B. A device capable of disconnecting DG facilities from the electric distribution system shall be located within 10 feet of the utility electric meter on residential and single building structures. Non-residential facilities with multiple buildings must install disconnect within 30 feet line of sight from electric meter. The disconnection device shall open with a visual break and be capable of disconnecting distributed generation. The switch shall be mounted at a height between 30 and 72 inches.
- C. Services with round meter sockets may require additional work or upgrading. Contact Alliant Energy if you have this type of meter socket.

518. DRAWINGS

Sample diagrams and metering drawings are shown in Sections 519 - 530. Consult Alliant Energy for larger installations or drawings not shown.



519. NET-METERED SELF-CONTAINED DISTRIBUTED GENERATION

100 – 300AMP 1-PHASE 120/240 VOLT

100 – 300AMP 1-PHASE 120/208 VOLT



Item No.	Description	Furnished & Installed By Utility	Furnished & Installed By Customer
1	Underground service cable	X	
2	Meter (outside)	X	
3	Customer service entrance panel (outside or inside)		X
4	Rigid conduit		X
5	Approved meter socket - do not modify lugs (see note #6 below)		X
6	Concrete sleeve		X
7	Conduit expansion joint		X
8	Conduit insulating bushing		X
9	Conduit straps		X
10	Grounding in accordance with the <i>NEC</i> (see Chapter 14)		X

NOTES:

- The applicant shall label the interconnection disconnect switch “Interconnection Disconnect Switch” by means of a permanently attached sign with clearly visible letters. The applicant shall provide and post its procedure for disconnecting the DG facility next to the switch.
DG disconnect must have a visible break and able to be locked open. Or, system must be capable of disconnecting and de-energizing the residual voltage in DG facility.
- DG disconnect and its location shall conform to technical guidelines and state requirements. Consult with Alliant Energy for details and specifications.
- Communication intersystem bonding is not allowed on, or in, any metering device.
- Intersystem bonding may only be done at the ground rod(s), on the Grounding Electrode Conductor or ground bus in customers main disconnect.
- Modification to lugs in meter socket is not allowed and may violate UL rating.
- The building or structure shall have a permanent plaque or directory within 10 feet of the meter that complies with the *NEC* 705.10 and *NEC* 690.56(B) requirements.
- Labeling at the meter socket shall indicate dual source, the voltage (example: 120/240; 120/208 or 277/480), maximum current and maximum power (kW) of solar/ DG source. Minimum 1/4 inch block lettering required on Alliant Energy approved label (see section 517).

519. NET-METERED SELF-CONTAINED DISTRIBUTED GENERATION WHERE SERVICE PLUS GENERATION DOES NOT EXCEED 120% OF SERVICE PANEL BUSS CAPACITY
 100 – 300AMP 1-PHASE 120/240 VOLT
 100 – 300AMP 1-PHASE 120/208 VOLT

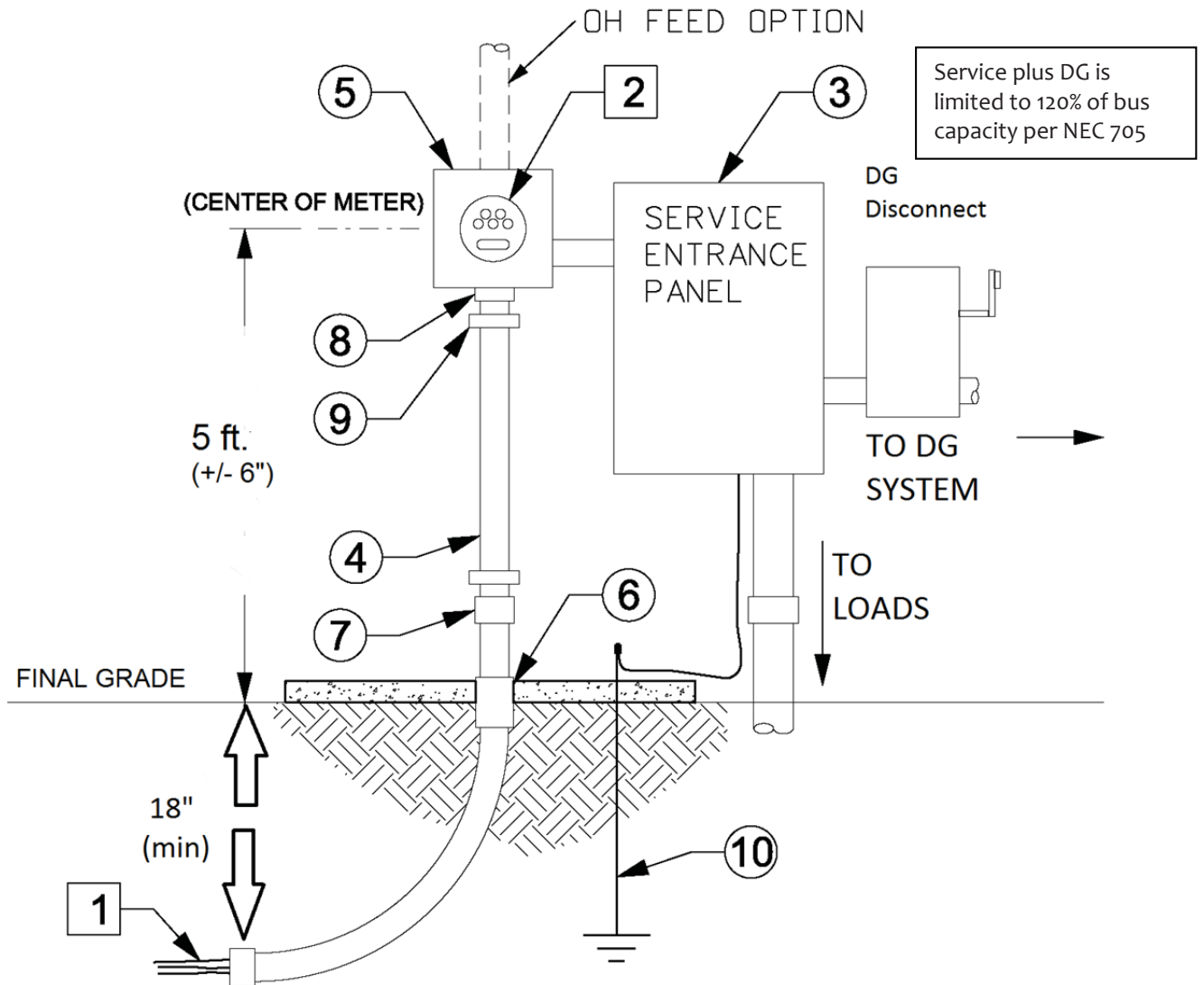

All DG equipment must be permanently labeled according to *NEC 705.10*.

Alliant Energy requires self-sticking brass or rigid plastic permanent label at meter socket for multiple or net metering.

519A. NET-METERED SELF-CONTAINED DISTRIBUTED GENERATION – CONTINUED

100 – 300AMP 1-PHASE 120/240 VOLT
 100 – 300AMP 1-PHASE 120/208 VOLT

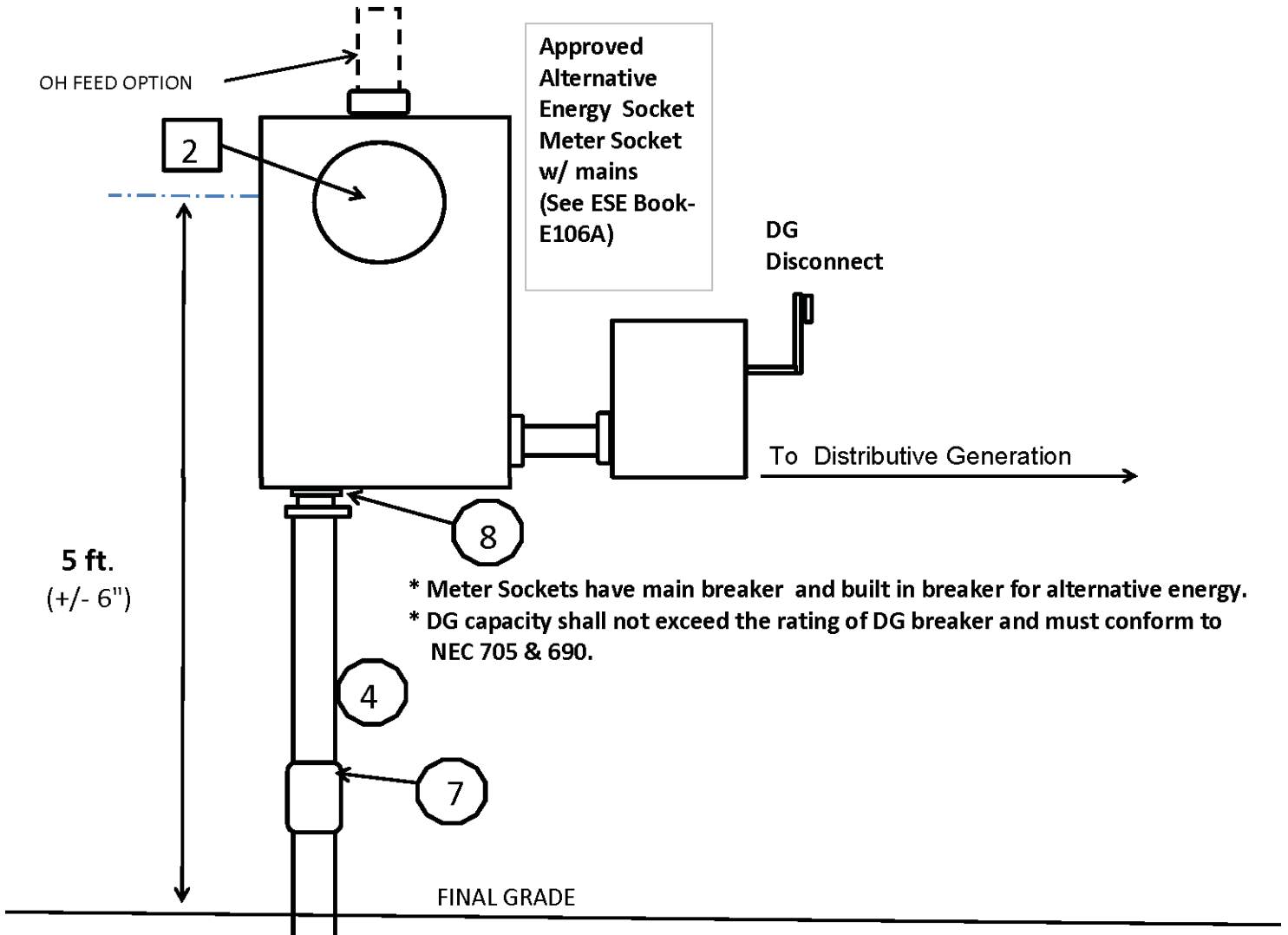

All DG equipment must be permanently labeled according to *NEC 705.10*.

Alliant Energy requires self-sticking brass or rigid plastic permanent label at meter socket for multiple or net metering.

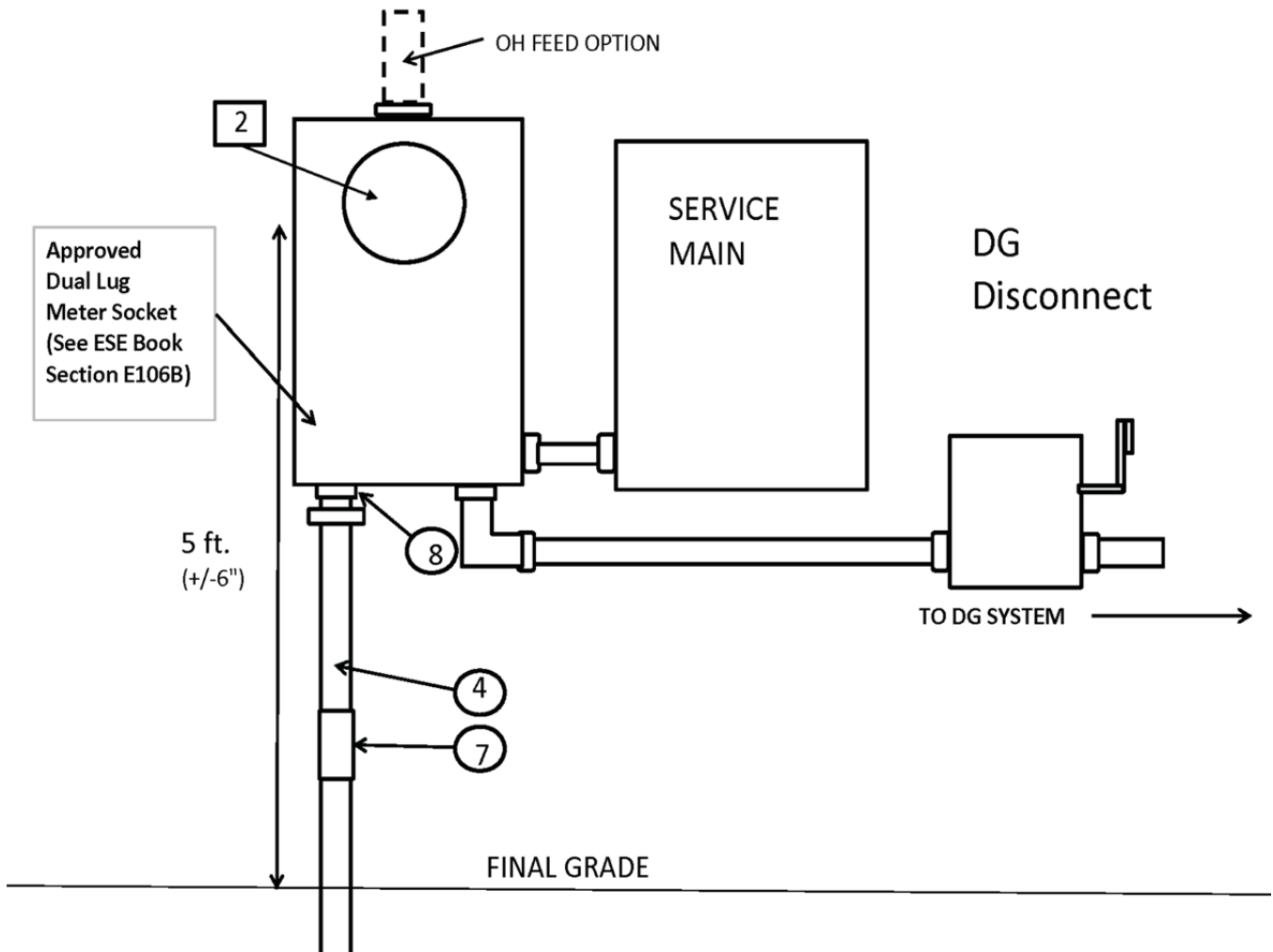
**519B. NET-METERED SELF-CONTAINED DISTRIBUTED GENERATION –
CONTINUED**
100 – 300AMP 1-PHASE 120/240 VOLT
100 – 300AMP 1-PHASE 120/208 VOLT

All DG equipment must be permanently labeled according to *NEC 705.10*.

Alliant Energy requires self-sticking brass or rigid plastic permanent label at meter socket for multiple or net metering.



520. NET-METERED DISTRIBUTED GENERATION FIELD BUILT STRUCTURE

100 - 300AMP – 1-PHASE 120/240 VOLT

100 - 300AMP – 3-PHASE 120/208 VOLT



Item No.	Description	Furnished & installed by utility	Furnished & installed by customer
1	Service drop	X	
2	Meter	X	
3	Field built structure		X
4	Approved meter socket - do not modify lugs (see note #6 below)		X
5	Treated 35'/5 pole		X
6	Grounding in accordance with the <i>NEC</i> (see Chapter 14)		X
7	Service entrance		X
8	Overhead service conduit with weather head		X
9	Feeder panels – as needed		X
10	Expansion sleeves – as needed		X
12	Conduit expansion joint		X

NOTES:

1. The applicant shall label the interconnection disconnect switch “Interconnection Disconnect Switch” by means of a permanently attached sign with clearly visible letters. The applicant shall provide and post the procedure for disconnecting the DG facility next to the switch.
2. DG disconnect must have a visible break and able to be locked open. Or, equipment must be capable of disconnecting and de-energizing the residual voltage in DG facility.
3. DG disconnect and its location shall conform to technical guidelines and state requirements. Consult with Alliant Energy for details and specifications.
4. Communication intersystem bonding is not allowed on, or in, any metering device.
5. Intersystem bonding may only be done at the ground rod(s), on the Grounding Electrode Conductor or ground bus in customers main disconnect.
6. Modification to lugs in meter socket is not allowed and may violate UL rating.
7. The building or structure shall have a permanent plaque or directory within 10 feet of the meter that complies with the *NEC* 705.10 and *NEC* 690.56(B) requirements.
8. Labeling at the meter socket shall indicate dual source, the voltage (example: 120/240; 120/208 or 277/480), maximum current and maximum power (kW) of solar/ DG source. Minimum 1/4 inch block lettering required on Alliant Energy approved label (see section 517).

520. NET-METERED DISTRIBUTED GENERATION FIELD BUILT STRUCTURE
- CONTINUED

100 – 300AMP 1-PHASE 120/240 VOLT

100 – 300AMP 3-PHASE 120/208 VOLT

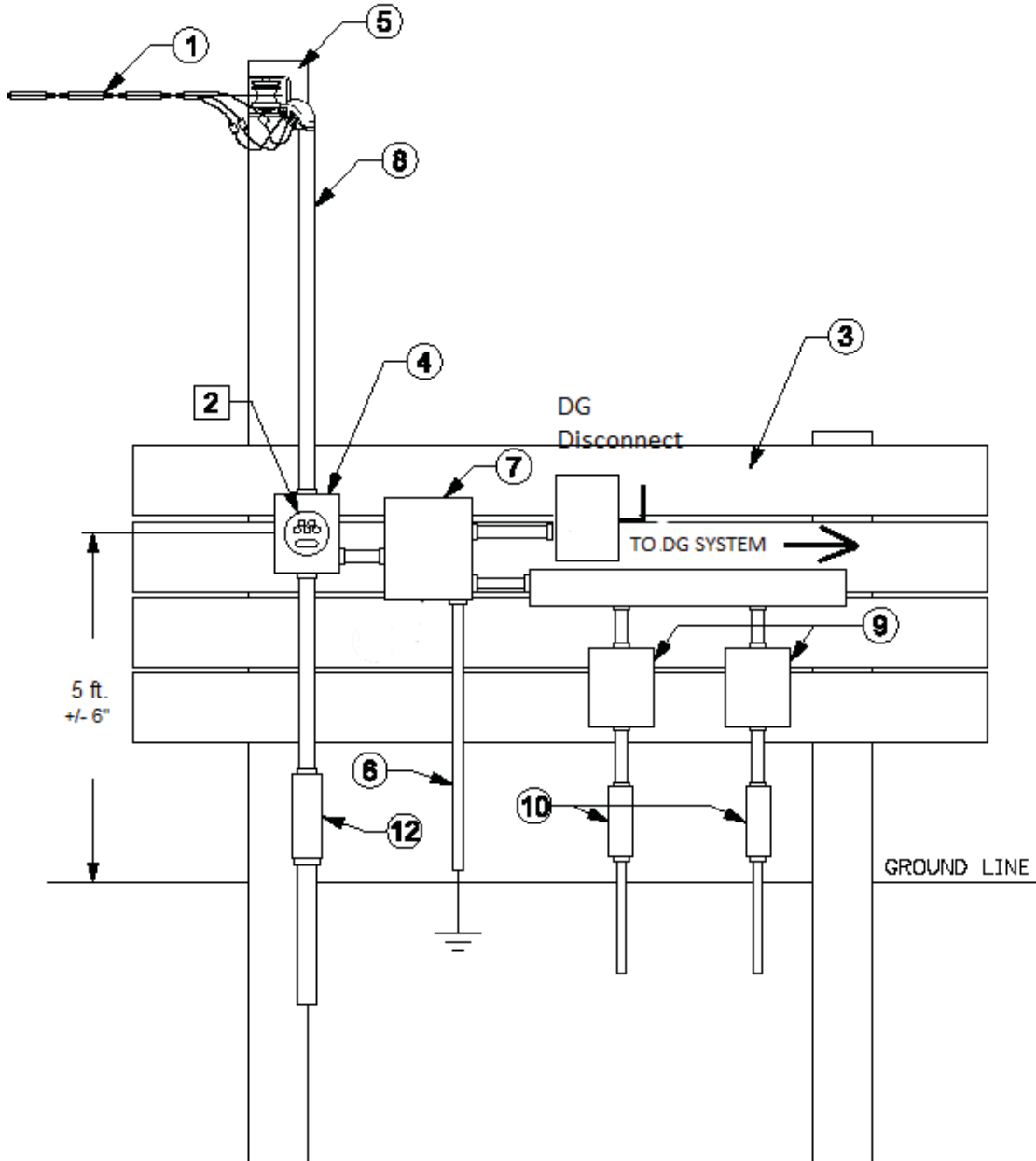

All DG equipment must be permanently labeled according to *NEC 705.10*.

Alliant Energy requires self-sticking brass or rigid plastic permanent label at meter socket for multiple or net metering.



521. DUAL-METERED FARM YARD-POLE DISTRIBUTED GENERATION

100 - 300AMP – 1-PHASE 120/240 VOLT

100 - 300AMP – 3-PHASE 120/208 VOLT



Item No.	Description	Furnished & installed by utility	Furnished & installed by customer
1	Service drop	X	
2	Service connectors	X	
3	Meters	X	
4	Pole - treated 35' class 5 minimum		X
5	Down guy, anchor and guy guard		X
6	Service entrance		X
7	Overhead service conduit		X
8	Weatherhead		X
9	Approved duplex meter socket		X
10	Grounding in accordance with the <i>NEC</i> (see Chapter 14)		X
11	Feeder conduit		X
12	Customer's feeder conductors		X
13	Distributed Generation disconnect (see note 3 below)		X

NOTES:

- Customer shall provide 36 inch leads at the weather head.
- If large equipment is to be driven under the service drop, see NESC 232.1. Drop shall be a minimum of 18 feet above ground at the lowest point.
- The applicant shall label the interconnection disconnect switch “Interconnection Disconnect Switch” by means of a permanently attached sign with clearly visible and letters. The applicant shall provide and post the procedure for disconnecting the DG facility next to the switch.
- DG disconnect must have a visible break and able to be locked open. Or, equipment must be capable of disconnecting and de-energizing the residual voltage in DG facility
- DG disconnect and its location shall conform to technical guidelines and state requirements. Consult with Alliant Energy for details and specifications.
- Communication intersystem bonding is not allowed on, or in, any metering device.
- Intersystem bonding may only be done at the ground rod(s), on the Grounding Electrode Conductor or ground bus in customers main disconnect.
- Modification to lugs in meter socket is not allowed and may violate UL rating
- The building or structure shall have a permanent plaque or directory within 10 feet of the meter that complies with the *NEC* 705.10 and *NEC* 690.56(B) requirements.
- Labeling at the meter socket shall indicate dual source, the voltage (example: 120/240; 120/208 or 277/480), maximum current and maximum power (kW) of solar/ DG source. Minimum ¼ inch block lettering required on Alliant Energy approved label (see section 517).

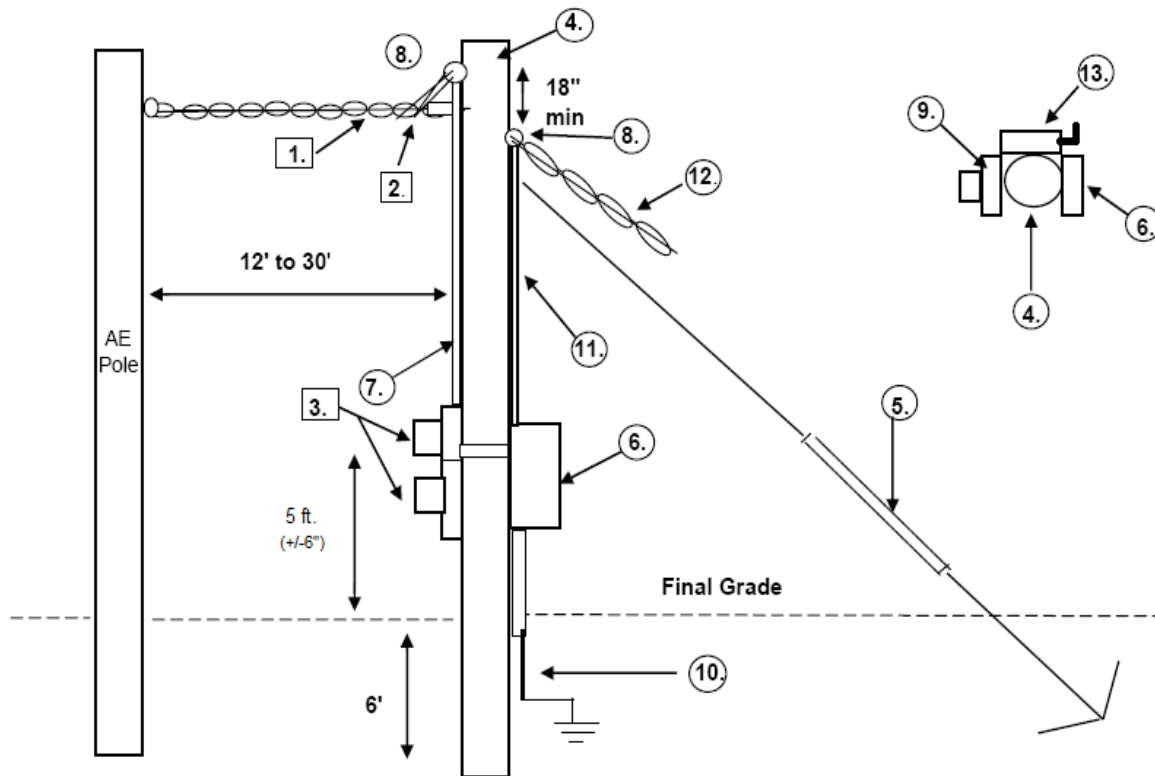
521. DUAL-METERED FARM YARD-POLE DISTRIBUTED GENERATION – CONTINUED
100 – 300AMP 1-PHASE 120/240 VOLT
100 – 300AMP 3-PHASE 120/208 VOLT

All DG equipment must be permanently labeled according to *NEC 705.10*.

Alliant Energy requires self-sticking brass or rigid plastic permanent label at meter socket for multiple or net metering.



522. NET-METERED FARM YARD-POLE DISTRIBUTED GENERATION

100 – 300AMP 1-PHASE 120/240 VOLT

100 – 300AMP 3-PHASE 120/208 VOLT



Item No.	Description	Furnished & installed by utility	Furnished & installed by customer
1	Service drop	X	
2	Service connectors	X	
3	Meter	X	
4	Pole - treated 35' class 5 minimum		X
5	Down guy, anchor and guy guard		X
6	Service entrance		X
7	Overhead service conduit		X
8	Weatherhead		X
9	Approved meter socket - do not modify lugs (see note #6 below)		X
10	Grounding in accordance with the <i>NEC</i> (see Chapter 14)		X
11	Feeder conduit		X
12	Customer's feeder conductors		X
13	Distributed Generation Disconnect		X

NOTES:

1. The applicant shall label the interconnection disconnect switch “Interconnection Disconnect Switch” by means of a permanently attached sign with clearly visible and letters. The applicant shall provide and post the procedure for disconnecting the DG facility next to the switch.
2. DG disconnect must have a visible break and able to be locked open. Or, equipment must be capable of disconnecting and de-energizing the residual voltage in DG facility.
3. DG disconnect and its location shall conform to technical guidelines and state requirements. Consult with Alliant Energy for details and specifications.
4. Communication intersystem bonding is not allowed on or in any metering device.
5. Intersystem bonding may only be done at the ground rod(s), on the Grounding Electrode Conductor or ground bus in customers main disconnect.
6. Modification to lugs in meter socket is not allowed and may violate UL rating.
7. The building or structure shall have a permanent plaque or directory within 10 feet of the meter that complies with the *NEC* 705.10 and *NEC* 690.56(B) requirements.
8. Labeling at the meter socket shall indicate dual source, the voltage (example: 120/240; 120/208 or 277/480), maximum current and maximum power (kW) of solar/ DG source. Minimum ¼ inch block lettering required on Alliant Energy approved label (see section 517).

522. NET-METERED FARM YARD-POLE DISTRIBUTED GENERATION – CONTINUED

100 – 300AMP 1-PHASE 120/240 VOLT

100 – 300AMP 3-PHASE 120/208 VOLT

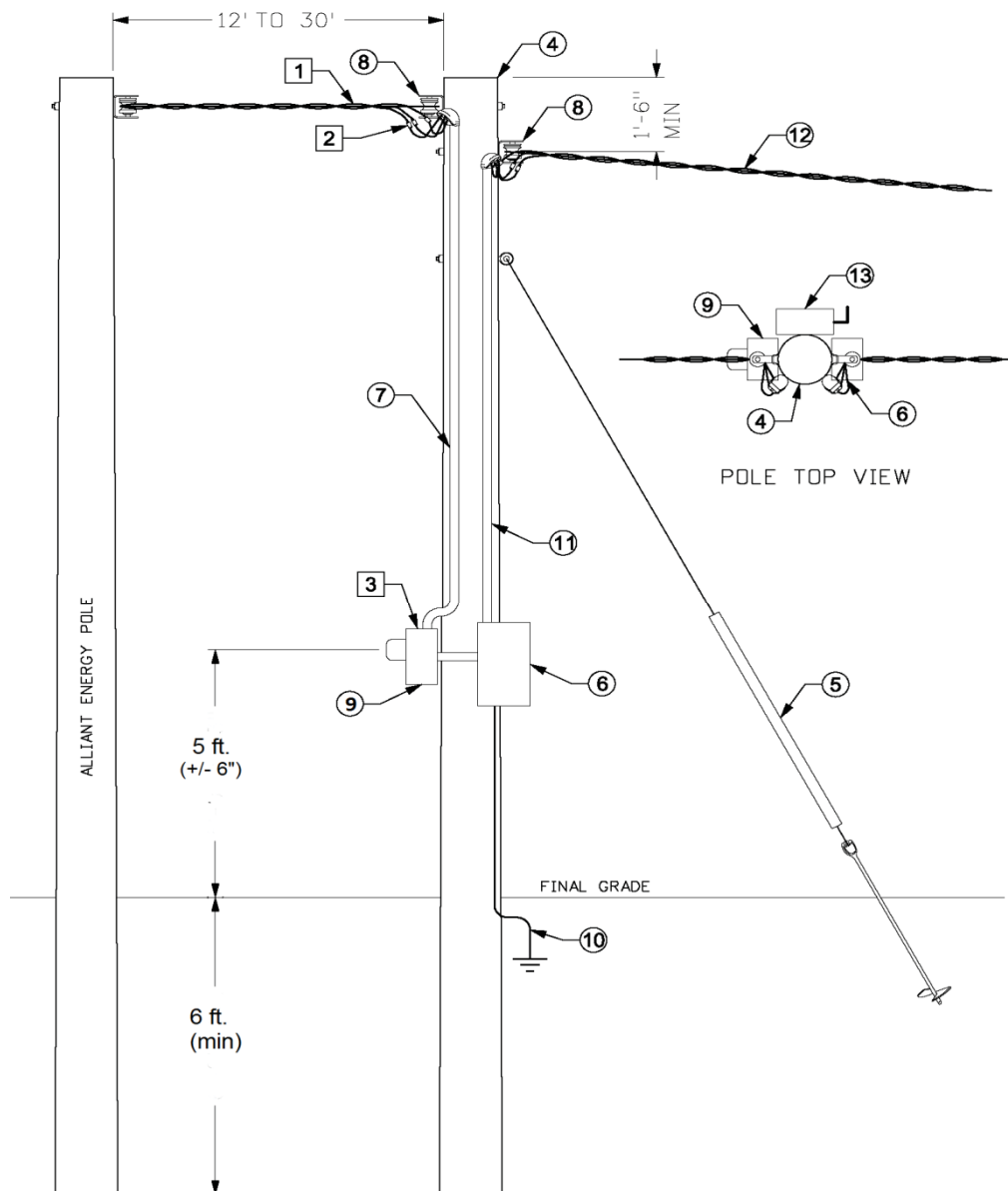

All DG equipment must be permanently labeled according to *NEC* 705.10.

Alliant Energy requires self-sticking brass or rigid plastic permanent label at meter socket for multiple or net metering.



523. GENERAL SERVICE INSTRUMENT METERED DISTRIBUTED GENERATION WITH SELF-CONTAINED METERING FOR DISTRIBUTED GENERATION

- 301 – 800 AMP 1-PHASE 120/240 VOLT
- 301 – 800 AMP 3-PHASE 120/208 VOLT
- 301 – 800 AMP 3-PHASE 277/480 VOLT



Item No.	Description	Furnished & installed by utility	Furnished & installed by customer
1	Meter	X	
2	Approved meter socket		X
3	Approved general service CT cabinet - do not modify lugs (see note #6 below)		X
4	Junction box		X
5	Approved DG meter socket		X
6	Grounding in accordance with the <i>NEC</i> (see Chapter 14)		X
7	DG Disconnect		X
8	Overhead conduit		X
9	Optional underground feed		X
10	Expansion joint		X

NOTES:

1. The applicant shall label the interconnection disconnect switch “Interconnection Disconnect Switch” by means of a permanently attached sign with clearly visible letters. The applicant shall provide and post the procedure for disconnecting the DG facility next to the switch.
2. DG disconnect must have a visible break and able to be locked open. Or, equipment must be capable of disconnecting and de-energizing the residual voltage in DG facility
3. DG disconnect and its location shall conform to technical guidelines and state requirements. Consult with Alliant Energy for details and specifications.
4. Communication intersystem bonding is not allowed on or in any metering device.
5. Intersystem bonding may only be done at the ground rod(s), on the Grounding Electrode Conductor or ground bus in customers main disconnect.
6. Modification to lugs in meter socket or CT cabinet is not allowed and may violate UL rating.
7. The building or structure shall have a permanent plaque or directory within 10 feet of the meter that complies with the *NEC* 705.10 and *NEC* 690.56(B) requirements.
8. Labeling at the meter socket shall indicate dual source, the voltage (example: 120/240; 120/208 or 277/480), maximum current and maximum power (kW) of solar/ DG source. Minimum ¼ inch block lettering required on Alliant Energy approved label (see section 517).

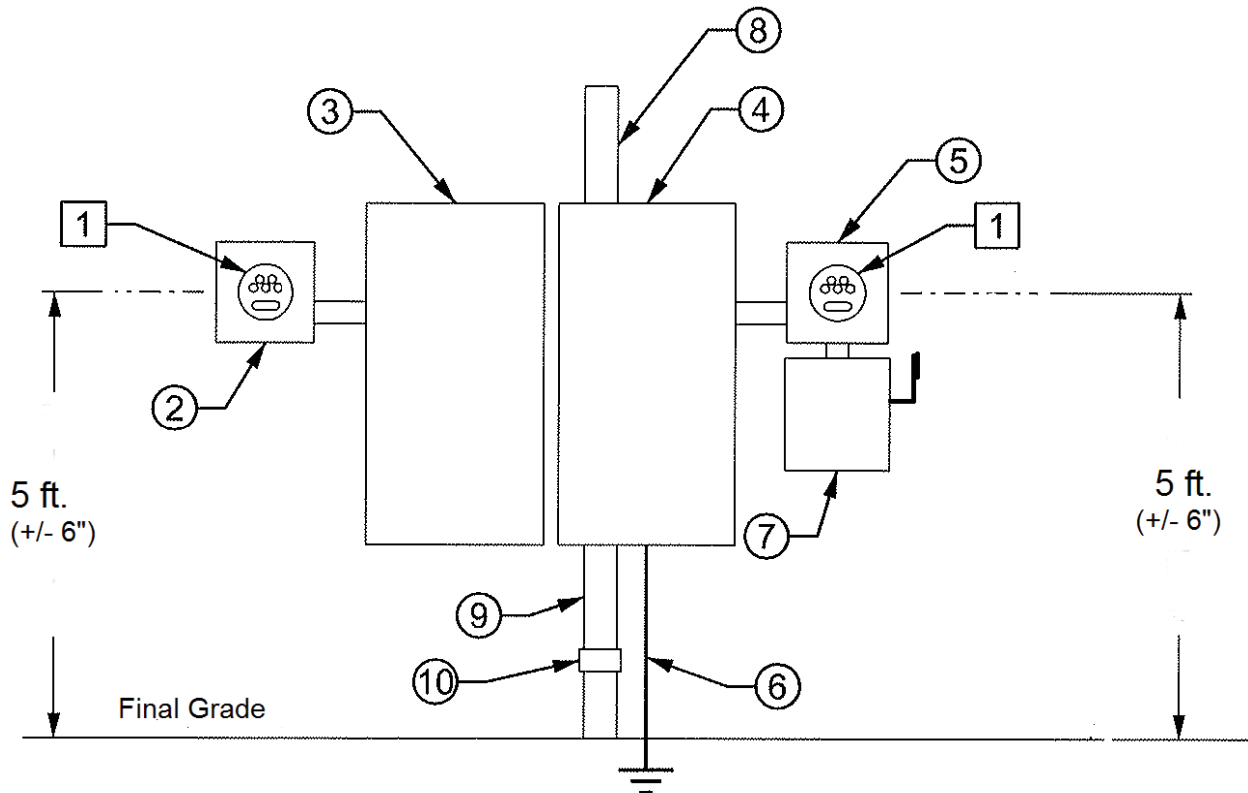
523. GENERAL SERVICE INSTRUMENT METERED DISTRIBUTED GENERATION WITH 0 - 200 AMP SELF-CONTAINED DISTRIBUTED GENERATION – CONTINUED
301 – 800 AMP 1-PHASE 120/240 VOLT
301 – 800 AMP 3-PHASE 120/208 VOLT

All DG equipment must be permanently labeled according to *NEC 705.10*.

Alliant Energy requires self-sticking brass or rigid plastic permanent label at meter socket for multiple or net metering.

523A. GENERAL SERVICE INSTRUMENT METERED DISTRIBUTED GENERATION WITH SELF-CONTAINED DG WHERE SERVICE PLUS GENERATION DOES NOT EXCEED 120% OF SERVICE PANEL BUSS CAPACITY

301 – 800 AMP 1-PHASE 120/240 VOLT
 301 – 800 AMP 3-PHASE 120/208 VOLT

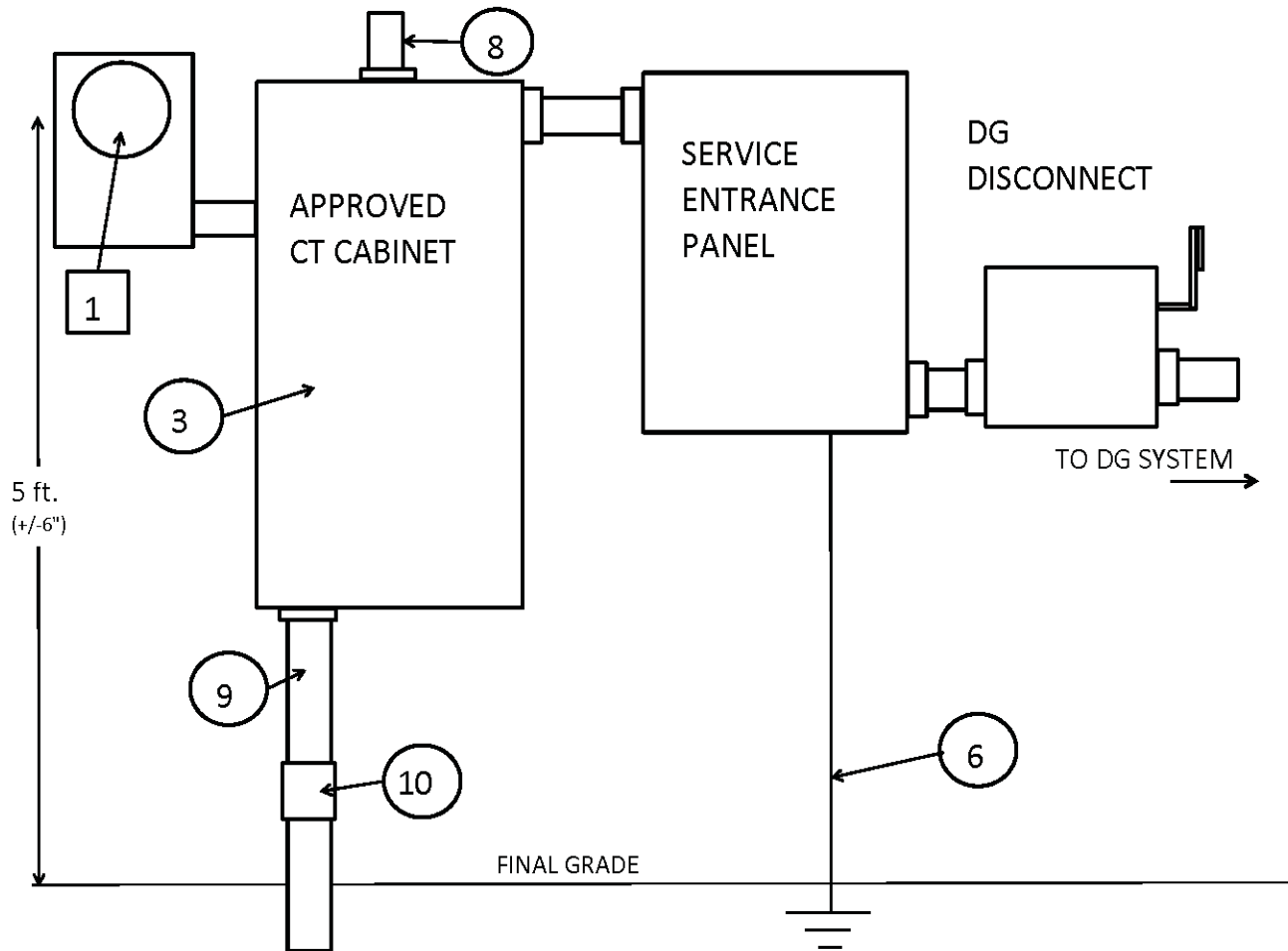

All DG equipment must be permanently labeled according to *NEC 705.10*.

Alliant Energy requires self-sticking brass or rigid plastic permanent label at meter socket for multiple or net metering.

523B. GENERAL SERVICE INSTRUMENT METERED DISTRIBUTED GENERATION WITH SELF-CONTAINED DG WHERE SERVICE PLUS GENERATION EXCEEDS 120% OF SERVICE PANEL BUSS CAPACITY
301 – 800 AMP 1-PHASE 120/240 VOLT
301 – 800 AMP 3-PHASE 120/208 VOLT

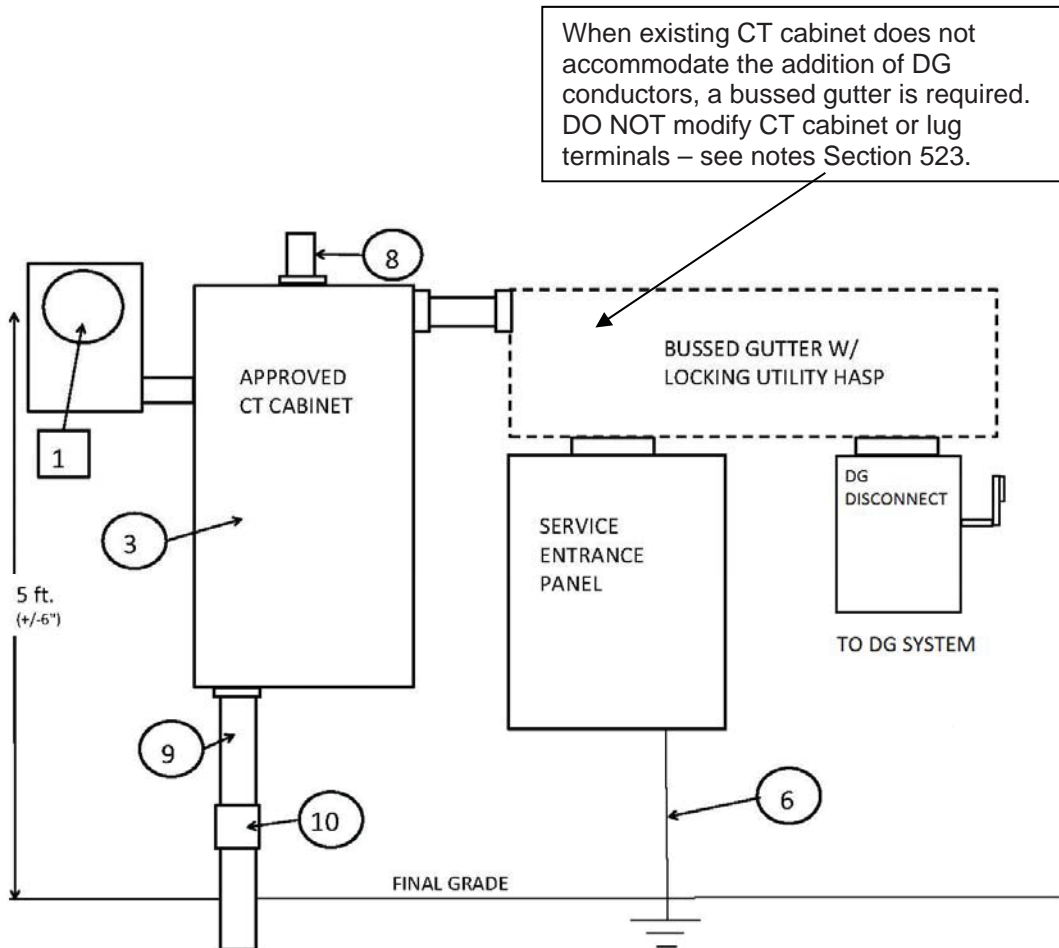

All DG equipment must be permanently labeled according to *NEC 705.10*.

Alliant Energy requires self-sticking brass or rigid plastic permanent label at meter socket for multiple or net metering.



524. GENERAL SERVICE INSTRUMENT METERED DISTRIBUTED GENERATION WITH 0 - 300AMP SELF - CONTAINED DISTRIBUTED GENERATION

100 – 800 AMP 3-PHASE 277/480 VOLT



Item No.	Description	Furnished & installed by utility	Furnished & installed by customer
1	Meter	X	
2	Approved meter socket		X
3	Approved general service CT cabinet		X
4	Junction box		X
5	Approved DG meter socket		X
6	Grounding in accordance with the <i>NEC</i> (see Chapter 14)		X
7	DG service entrance		X
8	Overhead conduit		X
9	Optional underground feed		X
10	Expansion joint		X
11	DG or load break disconnect		X

NOTES:

1. The applicant shall label the interconnection disconnect switch “Interconnection Disconnect Switch” by means of a permanently attached sign with clearly visible letters. The applicant shall provide and post its procedure for disconnecting the DG facility next to the switch.
2. DG disconnect must have a visible break and able to be locked open. Or, equipment must be capable of disconnecting and de-energizing the residual voltage in DG facility.
3. DG disconnect and its location shall conform to technical guidelines and state requirements. Consult with Alliant Energy for details and specifications.
4. Communication intersystem bonding is not allowed on or in any metering device.
5. Intersystem bonding may only be done at the ground rod(s), on the Grounding Electrode Conductor or ground bus in customers main disconnect.
6. The building or structure shall have a permanent plaque or directory within 10 feet of the meter that complies with the *NEC* 705.10 and *NEC* 690.56(B) requirements.
7. Labeling at the meter socket shall indicate dual source, the voltage (example: 120/240; 120/208 or 277/480), maximum current and maximum power (kW) of solar/ DG source. Minimum 1/4 inch block lettering required on Alliant Energy approved label (see section 517).

524. GENERAL SERVICE INSTRUMENT METERED DISTRIBUTED GENERATION WITH 0 - 300 AMP SELF-CONTAINED DISTRIBUTED - CONTINUED
300 - 800 AMP 3-PHASE 277/480 VOLT

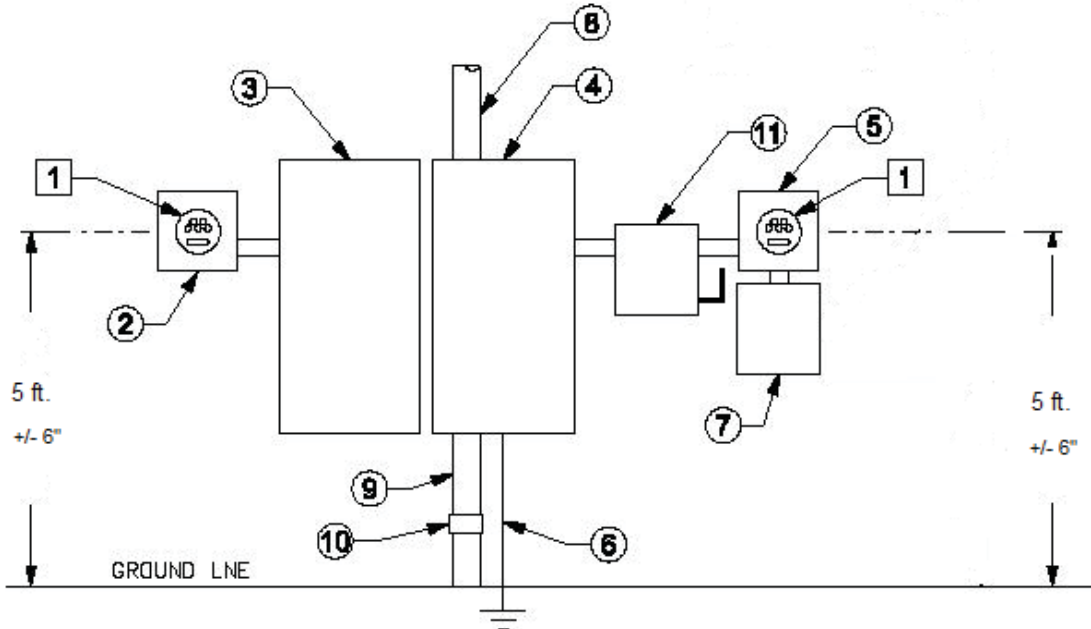

524A. NET-METERED SELF-CONTAINED WHERE SERVICE PLUS DISTRIBUTED GENERATION DOES NOT EXCEED 120% OF SERVICE PANEL BUSS CAPACITY
100 - 200 AMP 3-PHASE 277/480 VOLT (see notes on previous page)

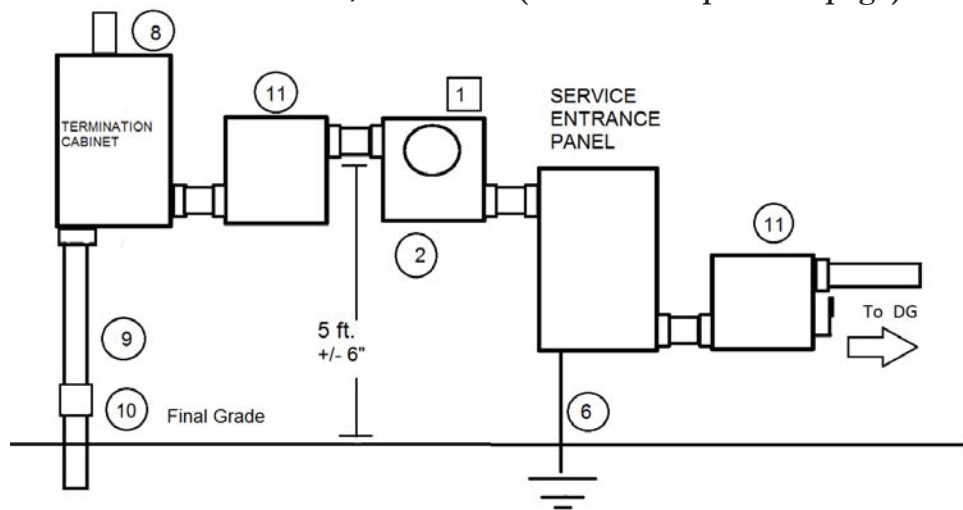

All DG equipment must be permanently labeled according to *NEC 705.10*. Alliant Energy requires self-sticking brass or rigid plastic permanent label at meter socket for multiple or net metering.



525. DUPLEX MANUFACTURED PEDESTAL DISTRIBUTED GENERATION
100 – 300 AMPS 1-PHASE 120/240 VOLT
100 – 300 AMPS 3-PHASE 120/208 VOLT



Item No.	Description	Furnished & installed by utility	Furnished & installed by customer
1	Meter	X	
2	Underground service lateral	X	
3	Approved duplex meter enclosure		X
4	Service entrance		X
5	DG disconnect		X
6	Grounding in accordance with the <i>NEC</i> (see Chapter 14)		X

NOTES:

1. The applicant shall label the interconnection disconnect switch “Interconnection Disconnect Switch” by means of a permanently attached sign with clearly visible and permanent letters. The applicant shall provide and post its procedure for disconnecting the DG facility next to the switch (*NEC* 705.22).
2. DG disconnect must have a visible break and able to be locked open. Or, equipment must be capable of disconnecting and de-energizing the residual voltage in DG facility.
3. DG disconnect and its location shall conform to technical guidelines and state requirements. Consult with Alliant Energy for details and specifications.
4. Communication intersystem bonding is not allowed on or in any metering device. Intersystem bonding may only be done at the ground rod(s) on the grounding, electrode conductor or ground bus in customers main disconnect.
5. The building or structure shall have a permanent plaque or directory within 10 feet of the meter that complies with the *NEC* 705.10 and *NEC* 690.56(B) requirements.
6. Labeling at the meter socket shall indicate dual source, the voltage (example: 120/240; 120/208 or 277/480), maximum current and maximum power (kW) of solar/ DG source. Minimum 1/4 inch block lettering required on Alliant Energy approved label (see section 517).

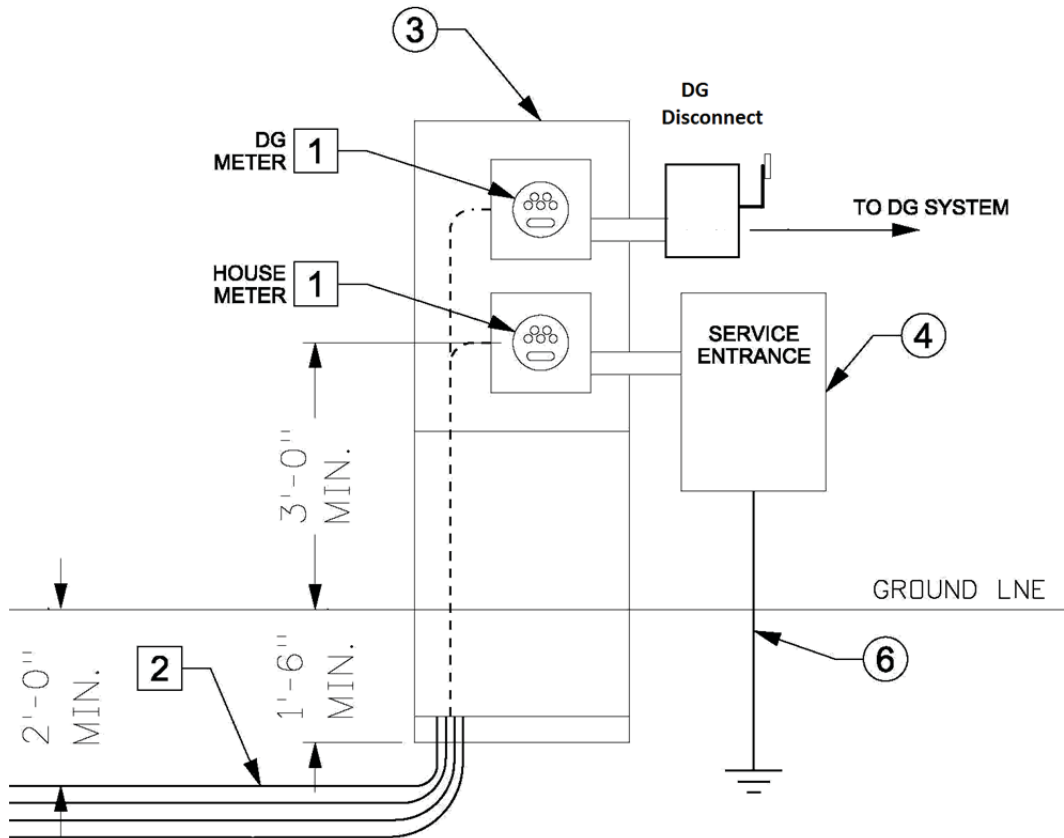
525. DUPLEX MANUFACTURED PEDESTAL DISTRIBUTED GENERATION – CONTINUED
100 – 300 AMPS 1-PHASE 120/240 VOLT
100 – 300 AMPS 3-PHASE 120/208 VOLT

All DG equipment must be permanently labeled according to NEC 705.10.

Alliant Energy requires self-sticking brass or rigid plastic permanent label at meter socket for multiple or net metering.



**526. DUAL INSTRUMENT TRANSFORMER DISTRIBUTED GENERATION
OPTIONAL - WALL MOUNTED, PAD MOUNTED OR ON FIELD BUILT**

- 301 – 800 AMP 1-PHASE 120/240 VOLT
- 301 – 800 AMP 3-PHASE 120/208 VOLT
- 301 – 800 AMP 3-PHASE 277/480 VOLT



Item No.	Description	Furnished & installed by utility	Furnished & installed by customer
1	Meter	X	
2	Approved meter socket		X
3	Approved DG meter socket		X
4	DG service entrance		X
5	General service CT cabinet		X
6	Approved termination cabinet		X
7	DG CT cabinet		X
8	Grounding in accordance with the <i>NEC</i> (see Chapter 14)		X
9	Optional equipment pad		X

NOTES:

1. The applicant shall label the interconnection disconnect switch “Interconnection Disconnect Switch” by means of a permanently attached sign with clearly visible letters. The applicant shall provide and post its procedure for disconnecting the DG facility next to the switch.
2. DG disconnect must have a visible break and able to be locked open. Or, equipment must be capable of disconnecting and de-energizing the residual voltage in DG facility.
3. DG disconnect and its location shall conform to technical guidelines and state requirements. Consult with Alliant Energy for details and specifications.
4. Communication intersystem bonding is not allowed on or in any metering device.
5. Intersystem bonding may only be done at the ground rod(s), on the Grounding Electrode Conductor or ground bus in customers main disconnect.
6. The building or structure shall have a permanent plaque or directory within 10 feet of the meter that complies with the *NEC* 705.10 and *NEC* 690.56(B) requirements.
7. Labeling at the meter socket shall indicate dual source, the voltage (example: 120/240; 120/208 or 277/480), maximum current and maximum power (kW) of solar/ DG source. Minimum ¼ inch block lettering required on Alliant Energy approved label (see section 517).

**526. DUAL INSTRUMENT TRANSFORMER DISTRIBUTED GENERATION
OPTIONAL - WALL MOUNTED, PAD MOUNTED OR ON FIELD BUILT
CONTINUED**

- 301 – 800 AMP 1-PHASE 120/240 VOLT
- 301 – 800 AMP 3-PHASE 120/208 VOLT
- 301 – 800 AMP 3-PHASE 277/480 VOLT

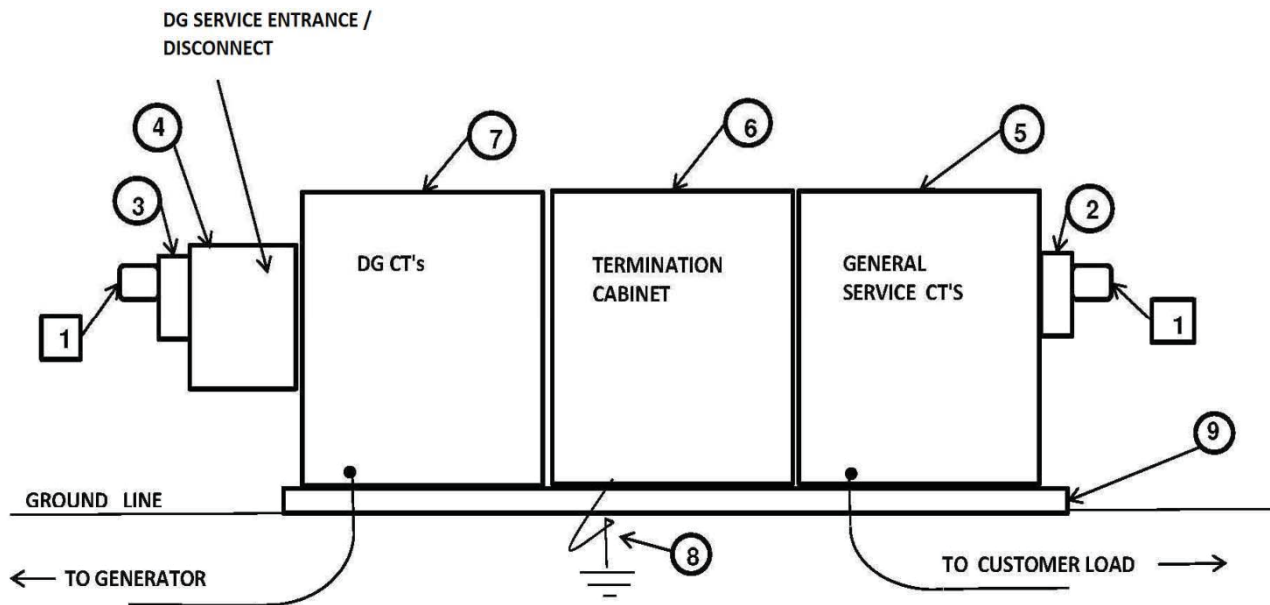

All DG equipment must be permanently labeled according to *NEC 705.10*.

Alliant Energy requires self-sticking brass or rigid plastic permanent label at meter socket for multiple or net metering.

527. PRIMARY METERED, PAD MOUNT SWITCHGEAR, DISTRIBUTED GENERATION- (Wisconsin Only)

Primary switchgear with net-metering for remote building

Building with photovoltaic panels with supply from primary service

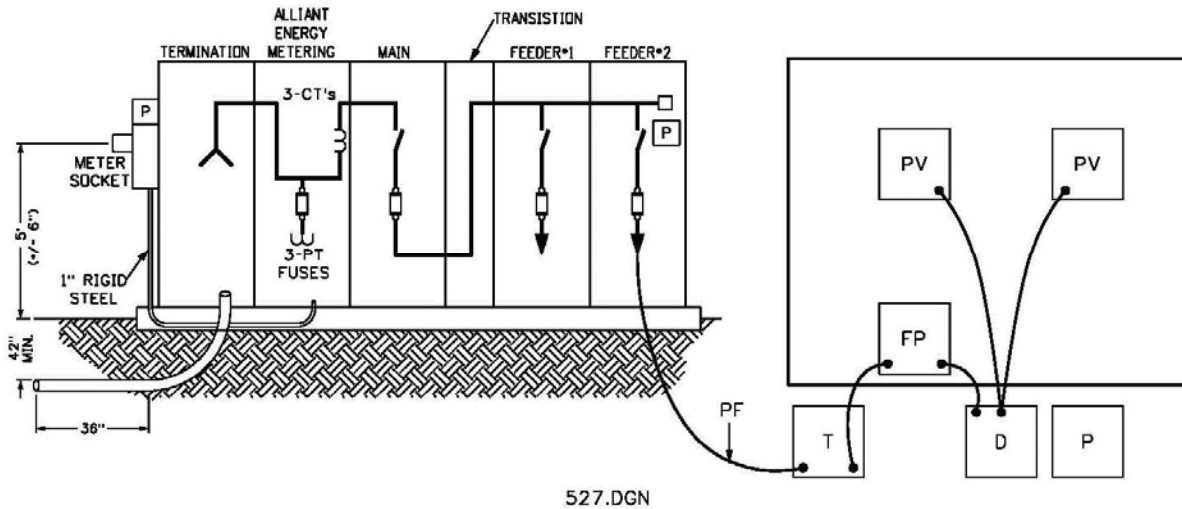

LEGEND

- MAIN = MAIN (Service Entrance)
- D = Disconnect for DG (with visible open and lockable in open position, located outside in a location readily accessible to the Fire Department.)
- M = Meter
- PV = Photovoltaic panels
- PF = Primary feeder
- FD = Feeder disconnect serving building with photovoltaic panels.
- T = Transformer
- P = Plaque (At the primary switchgear, install plaques at both the meter and at the primary feeder disconnect serving the building with PV. At the building with photovoltaic panels, install a plaque adjacent to the photovoltaic disconnect.)
- FP = Building's feeder panel

528. DISTRIBUTED GENERATION, BUILDING WITH NET METERING FOR REMOTE BUILDING WITH BUILDING LOAD FEEDER PANEL

Building with net-metering
for remote building

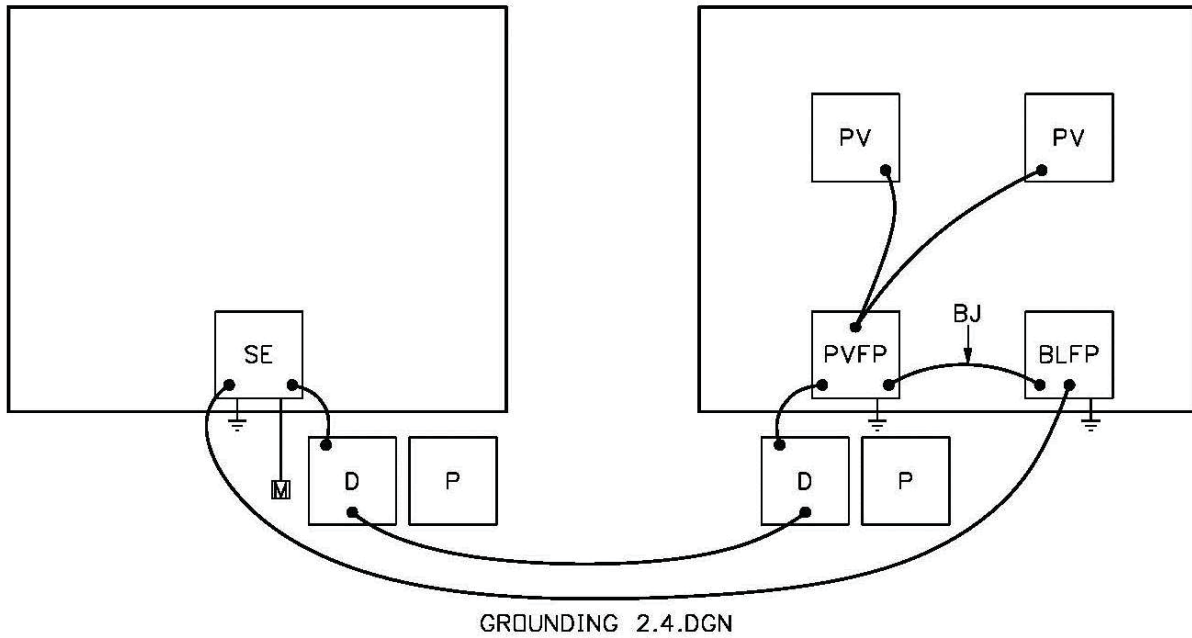
Building with
photovoltaic panels



LEGEND

- SE = Service entrance
- D = Disconnect for DG (with visible open and lockable in open position)
- M = Meter
- PV = Photovoltaic panels
- BJ = Bonding jumper
- P = Plaque
- BLFP = Building load feeder panel
- PVFP = Photovoltaic feeder panel