

CAI-C10 LED Music Spectrum Clock DIY Kit

1.Introduction:

CAI-C10 is LED Music Spectrum Flashing Electronic Clock Circuit Electronic Soldering DIY Kit. Automatically display the music spectrum when there is sound; Display the current time when there is no sound. Users can choose to switch between 18 music spectrum display modes and so on.

It can not only be used as a DIY electronic welding kit that allows you to better understand the circuit and learn how to soldering, but also as a very suitable experimental workbench tool.

2.Feature:

- 1>.18 Music Spectrum Display Modes
- 2>.Automatically Switch Between Spectrum and Clock
- 3>.Adjustable Audio Sensitivity
- 4>.Adjustable Display Brightness
- 5>.Nighttime Power-saving Mode
- 6>.12H/24H System Switchable
- 7>.Classic 8*8 LED Dot Matrix Display Screen
- 8>.Dual USB Power Supply
- 9>.DIY Hand Soldering

3.Parameter:

- 1>.Work voltage: DC 5V
- 2>.Display Color: Green
- 3>.Power Type: Micro USB
- 4>.Work Temperature:-40°C~85°C
- 5>.Work Humidity:5%~95%RH
- 6>.Size(Installed):128*32*18mm

4.Use Methods:

1>.Automatically display the music spectrum when there is sound; Display the current time when there is no sound.

2>.Display Hour:Minute:Second at Clock Display Mode.

3>.**18 Display Effects:** Click button to switch LED Music Spectrum Display Mode in 18 Display Effects:

3.1>.Mode 1: Floating Point and 2-Columns Vertical Chart real time display mode.

3.2>.Mode 2: Level and 2-Columns Vertical Chart real time display mode.

3.3>.Mode 3: 2-Columns Vertical Chart real time display mode.

3.4>.Mode 4: Level Digital and Horizontal real time display mode.

3.5>.Mode 5: Horizontal real time display mode.

3.6>.Mode 6: Floating Point and 3-Rows Horizontal real time display mode.

3.7>.Mode 7: Vertical real time display mode.

3.8>.Mode 8: Vertical in Central Axis real time display mode.

3.9>.Mode 9: Floating Point and 3-Columns Vertical Chart real time display mode.

3.10>.Mode 10: Vertical Floating Point real time display mode.

3.11>.Mode 11: Floating Point and 2-Rows Horizontal real time display mode.

3.12>.Mode 12: Lateral Shift Half Wave real time display mode.

3.13>.Mode 13: Lateral Shift Full Wave real time display mode.

3.14>.Mode 14: Level Digital and Lateral Shift Half Wave real time display mode.

3.15>.Mode 15: Vertical and Lateral Shift Full Wave real time display mode. Left and right split screen display.

3.16>.Mode 16: Floating Point and 1-Row Horizontal real time display mode.

3.17>.Automatic Display Mode 1: Automatically switch display mode from Mode1 to Mode16 by turns. The switching time interval can be set with parameter 'TIME'.

3.18>.Automatic Display Mode 2: Automatically random switch display mode between Mode1 and Mode16. The switching time interval can be set with parameter 'TIME'.

4>.Parameter Set Mode:

4.1>.Keep press button 1 second to switch parameter.

4.2>.Short press button to change parameter value.

4.3>.The currently selected parameter keep flashing.

4.4>.Automatic save parameter and exit from Parameter Set Mode if there is no operate within 8second.

4.5>.**Enter Set Mode:** Keep press button 1 second enter into Parameter Set Mode. Click button to change parameter value and keep press again to set the next parameter.The currently selected parameter keep flashing.

4.6>.**Switch 12H/24H Display Mode:** Default setting for 12/24H mode after inter Parameter Set Mode. Click button to change 12H or 24H display mode.

4.7>.**Set Hour:** Keep press again to Set Hour. Click to increase value. It automatically changes to the minimum value and starts increasing again when the value increases to the maximum value.

4.8>.**Set Minute:** Keep press again to Set Minute. Click to increase value. It automatically changes to the minimum value and starts increasing again when the value increases to the maximum value.

4.9>.**Set Audio Sensitivity 'SENS':** Keep press again to Set Audio Sensitivity. Its set range is 1 to 12.The larger the parameter value, the higher the sensitivity of the sensing sound, and the easier it is to display the spectrum.

4.10>.**Set Switch Time Interval 'TIME':** Keep press again to Set Switch Time Interval. It is just can available for Automatic Display Mode 1 and Automatic Display Mode 2. It is used to set the time interval for automatic switching of spectrum modes. Its set range is 5 to 20 second.

4.11>.**Set Display Mode 'IMAGE':** Keep press again to Set Display Mode. It is used to set the movement direction of each LED pixel point.

4.11.1>.' 0 ': Display from left to right in X-axle and from bottom to top in Y-axle.

4.11.2>.' X ': Display from right to left in X-axle and from bottom to top in Y-axle.

4.11.3>.' Y ': Display from left to right in X-axle and from top to bottom in Y-axle.

4.12>.**Set Display Refresh Rate 'SPEED':** Keep press again to Display Refresh Rate. Its set range is 1 to 4. The larger the parameter value,the faster the screen refresh rate.

4.13>.**Set Display Brightness 'LED':** Keep press again to Display Brightness. Its set range is 1 to 7. The larger the parameter value,the higher the display brightness.

4.14>.**Set Switch Delay 'DELAY':** Keep press again to set switch delay time. Its set range is 1 to 8 which means the delay is DELAY*3 second such as 2*3=6s. It will automatically switch to displaying the current time when it cannot receive the sound signal to display the music spectrum with in DELAY*3s.

4.15>.**Set Nighttime Power-saving Mode 'D':** It can turn ON/OFF this function and set time range.

4.11.1>.' 0 ': Turn OFF nighttime power-saving function which means the screen will keep the same brightness in 24 hour.

4.11.2>.' 1 ': Turn ON nighttime power-saving function which means display screen maintains minimum brightness in the set time range.

4.11.3>.' xx:yy ': Set time range for nighttime power-saving function. ' xx:yy ' means time from xx hour to yy hour.Such as '21:07' means display screen maintains minimum brightness from 21:00 to 7:00.

5>.**Restore Factory Settings:** Keep press button and then power ON. All LED will automatically flash a few times then Release button. The display screen will flash. Click button can complete restore and return to normal display status.

5.Component Listing:

NO.	Component Name	PCB Marker	Parameter	QTY
1	STC8H1K16-36I Controller	U1	LQFP32	1
2	DS1302 Clock IC	U2	SOP-8	1
3	Electrolytic Capacitor	C1	1000uF	1
4	0805 SMD Capacitor	C2	0.1uF	1
5	0805 SMD Capacitor	C3,C4	22pF	2

6	Crystal Oscillator	Y1	32.768KHz	1
7	SMD Black Button	SW		1
8	Microphone Module	AD		1
9	Micro USB Socket		2Pin	1
10	Micro USB Socket		5Pin	1
11	CR1220 Battery	BT1	3V	1
12	CR1220 Battery Socket	BT1		1
13	8*8 Dot Matrix Screen	LED1-LED4		4
14	Micro USB Power Wire			1
15	Filter			1
16	PCB Circuit Board		128*32mm	1

Note:Users can complete the installation according to the PCB silk screen and component list.

6.Schematic Diagram:

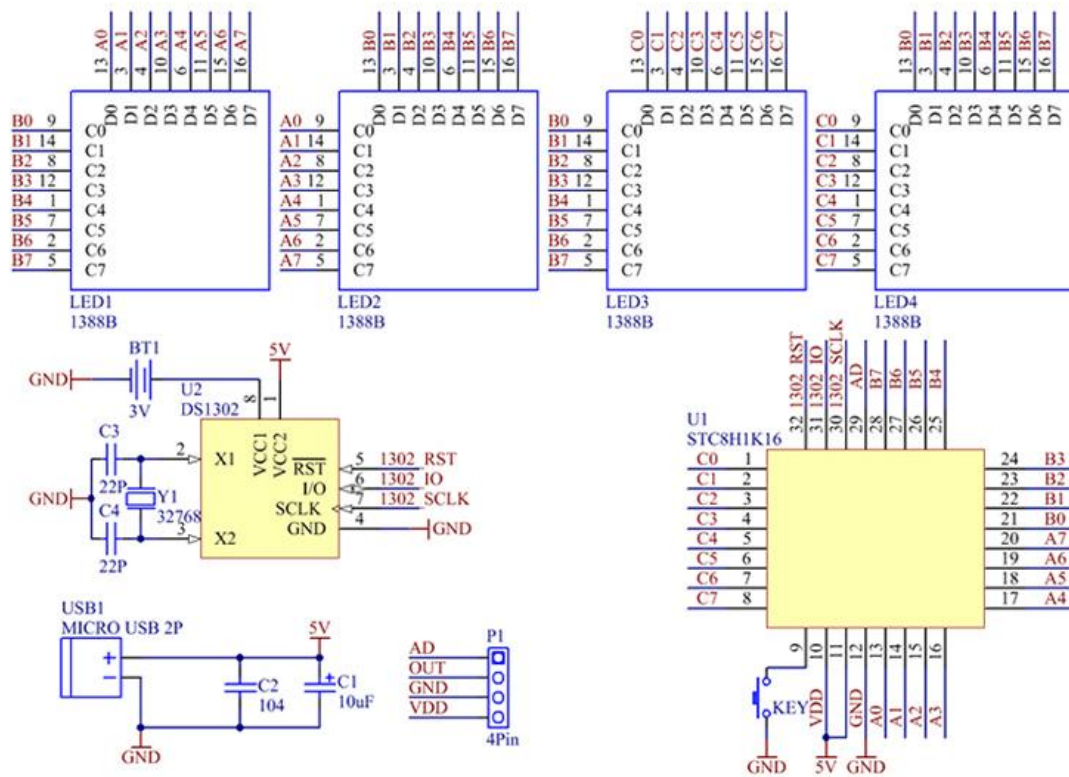

7.Application:

- 1>.Training welding skills
- 2>.Student school
- 3>.DIY production
- 4>.Project Design
- 5>.Electronic competition
- 6>.Gift giving
- 7>.Crafts collection
- 8>.Home decoration
- 9>.Souvenir collection
- 10>.Graduation design
- 11>.Holiday gifts

8.Installation Tips:

- 1>.User needs to prepare the welding tool at first.

- 1.1>.Soldering iron (<50 Watt)
- 1.2>.Rosin core ("radio") solder
- 1.3>.Wire cutters
- 1.4>.Wire strippers
- 1.5>.Screwdriver
- 2>.Please be patient until the installation is complete.
- 3>.The package is DIY kit.It need finish install by user.
- 4>.The soldering iron can't touch the components for a long time(1.0 second), otherwise it will damage the components.
- 5>.Pay attention to the positive and negative of the components.
- 6>.Strictly prohibit short circuit.
- 7>.User must install the LED according to the specified rules.Otherwise some LED will not light.
- 8>.Install complex components preferentially.
- 9>.Make sure all components are in right direction and right place.
- 10>.It is strongly recommended to read the installation manual before starting installation!!!
- 11>.Please wear anti-static gloves or anti-static wristbands when installing electronic components.

9.Installation Steps(Please be patient install!!!):

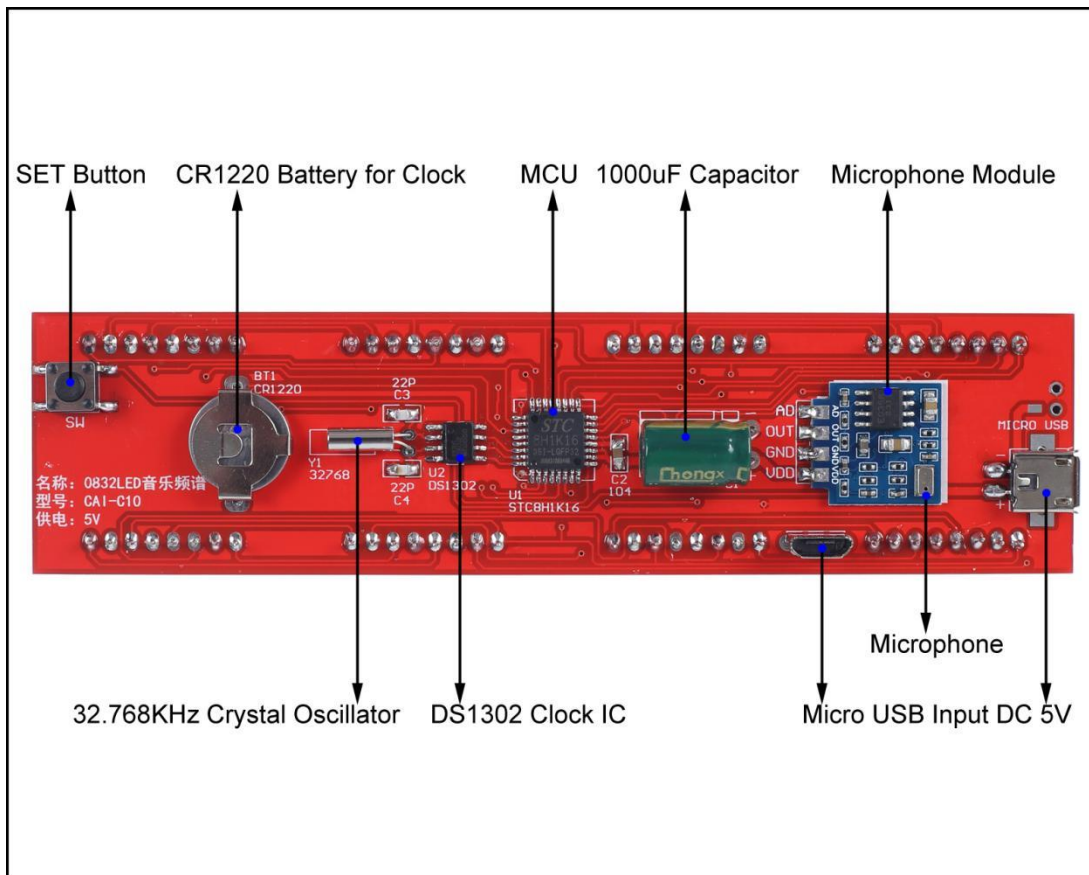

Parameter Set Mode	
1>.Keep press button 1 second to switch parameter. 2>.Short press button to change parameter value. 3>.The currently selected parameter keep flashing. 4>.Keep press again to set the next parameter. 5>.Automatic save parameter and exit from Parameter Set Mode if there is no operate within 8second.	
1.Switch 12H/24H Display Mode: Change 12H or 24H display mode and set Hour and Minute at this interface.	
2.Set Audio Sensitivity 'SENS': Range is 1 to 12. The larger value, the higher sound sensitivity and the easier it is to display the spectrum.	
3.Set Switch Time Interval 'TIME': It is just can available for Automatic Display Mode 1 and Automatic Display Mode 2. It is used to set the time interval for automatic switching of spectrum modes. Its set range is 5 to 20 second.	
4.Set Display Mode 'IMAGE': 1>.'0': Display from left to right in X-axis and from bottom to top in Y-axis. 2>.'X': Display from right to left in X-axis and from bottom to top in Y-axis. 3>.'Y': Display from left to right in X-axis and from top to bottom in Y-axis.	
5.Set Display Refresh Rate 'SPEED': Its set range is 1 to 4. The larger the parameter value, the faster the screen refresh rate.	
6.Set Display Brightness 'LED': Its set range is 1 to 7. The larger the parameter value, the higher the display brightness.	
7.Set Switch Delay 'DELAY': Its set range is 1 to 8 which means the delay is DELAY*3s such as 2*3=6s. It will automatically switch to display time when it cannot receive the sound signal to display the music spectrum with in DELAY*3s.	
8.Set Nighttime Power-saving Mode 'D': 1>.'0': Turn OFF power-saving function which means screen keep the same brightness in 24 hour. 2>.'1': Turn ON this function which means screen maintains minimum brightness in the set time range. 3>.'xx:yy': Set time range for nighttime power-saving function. 'xx:yy' means time from xx hour to yy hour. Such as '21:07' means display screen maintains minimum brightness from 21:00 to 7:00.	

18 Music Spectrum Display Modes by Click Button		
Mode 1: Floating Point and 2-Columns Vertical Chart real time display mode.	Mode 2: Level and 2-Columns Vertical Chart real time display mode.	Mode 3: 2-Columns Vertical Chart real time display mode.
Mode 4: Level Digital and Horizontal real time display mode.	Mode 5: Horizontal real time display mode.	Mode 6: Floating Point and 3-Rows Horizontal real time display mode.
Mode 7: Vertical real time display mode.	Mode 8: Vertical in Central Axis real time display mode.	Mode 9: Floating Point and 3-Columns Vertical Chart real time display mode.
Mode 10: Vertical Floating Point real time display mode.	Mode 11: Floating Point and 2-Rows Horizontal real time display mode.	Mode 12: Lateral Shift Half Wave real time display mode.
Mode 13: Lateral Shift Full Wave real time display mode.	Mode 14: Level Digital and Lateral Shift Half Wave real time display mode.	Mode 15: Vertical and Lateral Shift Full Wave real time display mode. Left and right split screen display.
Mode 16: Floating Point and 1-Row Horizontal real time display mode.	Automatic Display Mode 1 Automatically switch display mode from Mode1 to Mode16 by turns. The switching time interval can be set with parameter 'TIME'.	Automatic Display Mode 2 Automatically random switch display mode between Mode1 and Mode16. The switching time interval can be set with parameter 'TIME'.

Step 1: Install 1pcs SMD components LQFP32 STC8H1K16-36I Controller at U1. Verify and confirm the installation direction of STC8H1K16. There is a smaller dot mark on one corner of IC and there is a gap mark and white dot on PCB silk screen where the IC can place on. These two marks are corresponding to each other and are used to specify the installation direction of the IC.

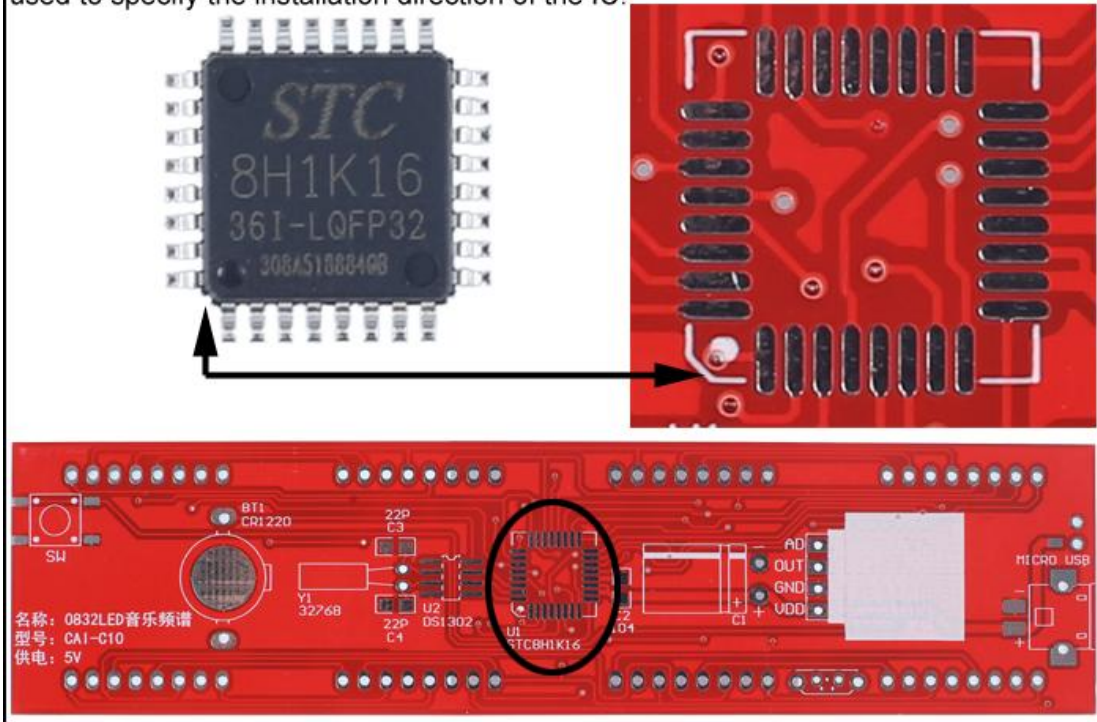

Step 2: Randomly choose a pad on the PCB, and then melt the solder on this pad.

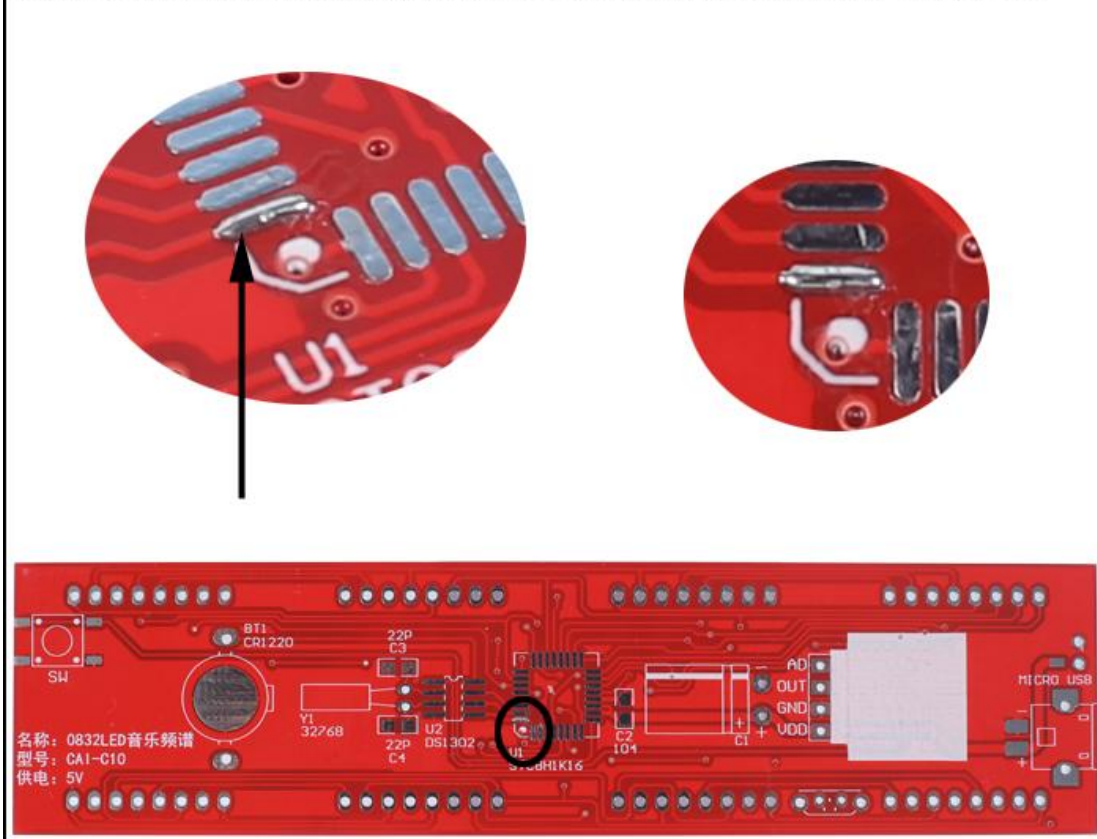

Step 3: Fix STC8H1K16: Use a soldering iron to melt tin on the pad just now and hold STC8H1K16 with tweezers in the other hand to place/press on U1 to prevent movement. Take care to match and align each pads. Then remove soldering iron. Then remove tweezers after solder tin cooling and solidification.

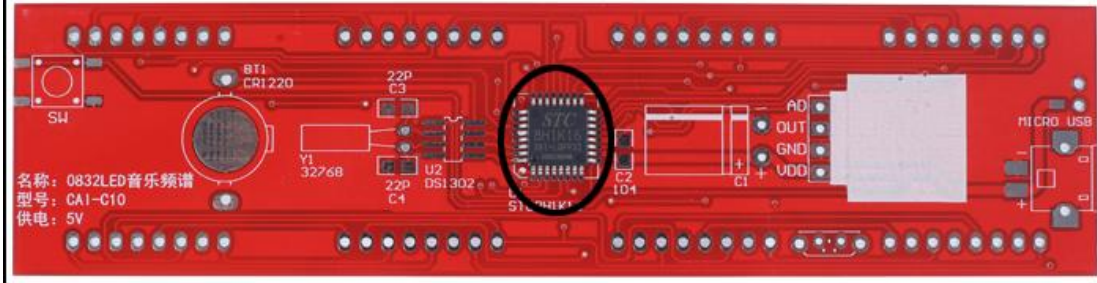
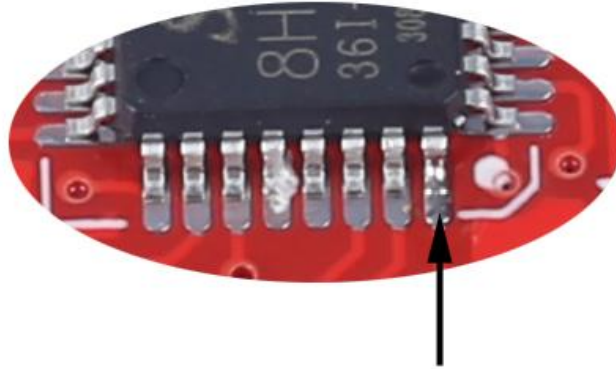

Step 4: Connect others pads on STC8H1K16 by tin and soldering iron. Note: This is just the most basic installation method if your welding tools are not complete.

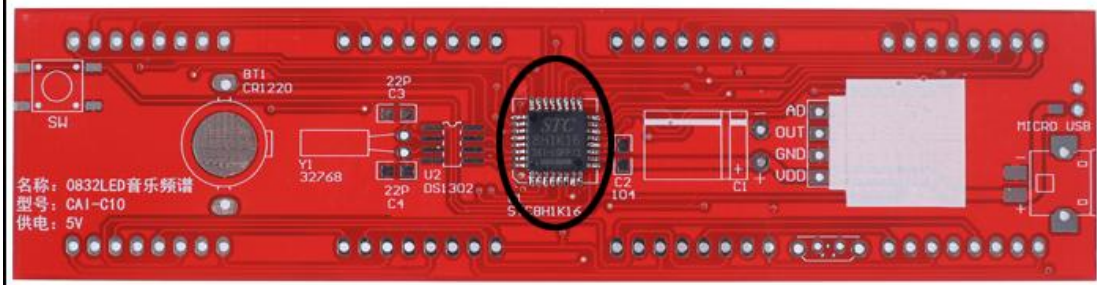
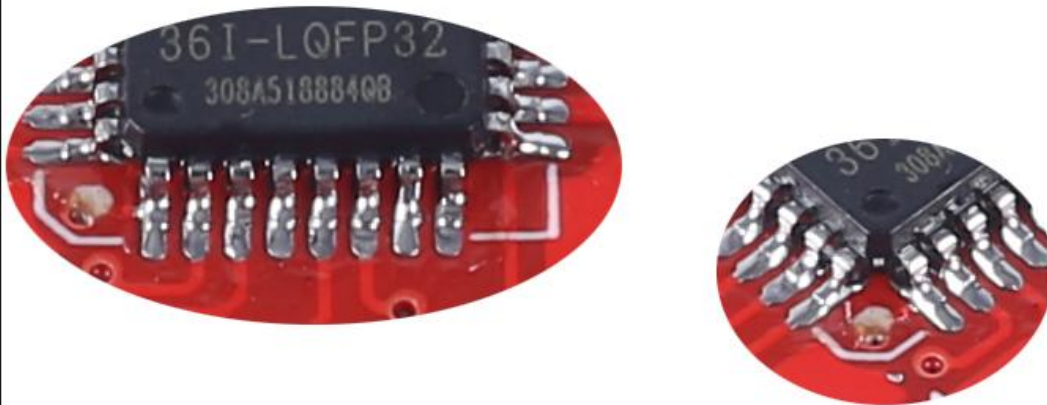

Step 5: Install 1pcs SOP-8 DS1302 Clock IC at U2 by the same methods.



Step 6: Install 2pcs 22pF 0805 SMD Capacitor at C3,C4.



Step 7: Install 1pcs 0.1uF 0805 SMD Capacitor at C2.



Step 8: Install 1pcs Microphone Module and align each pad.

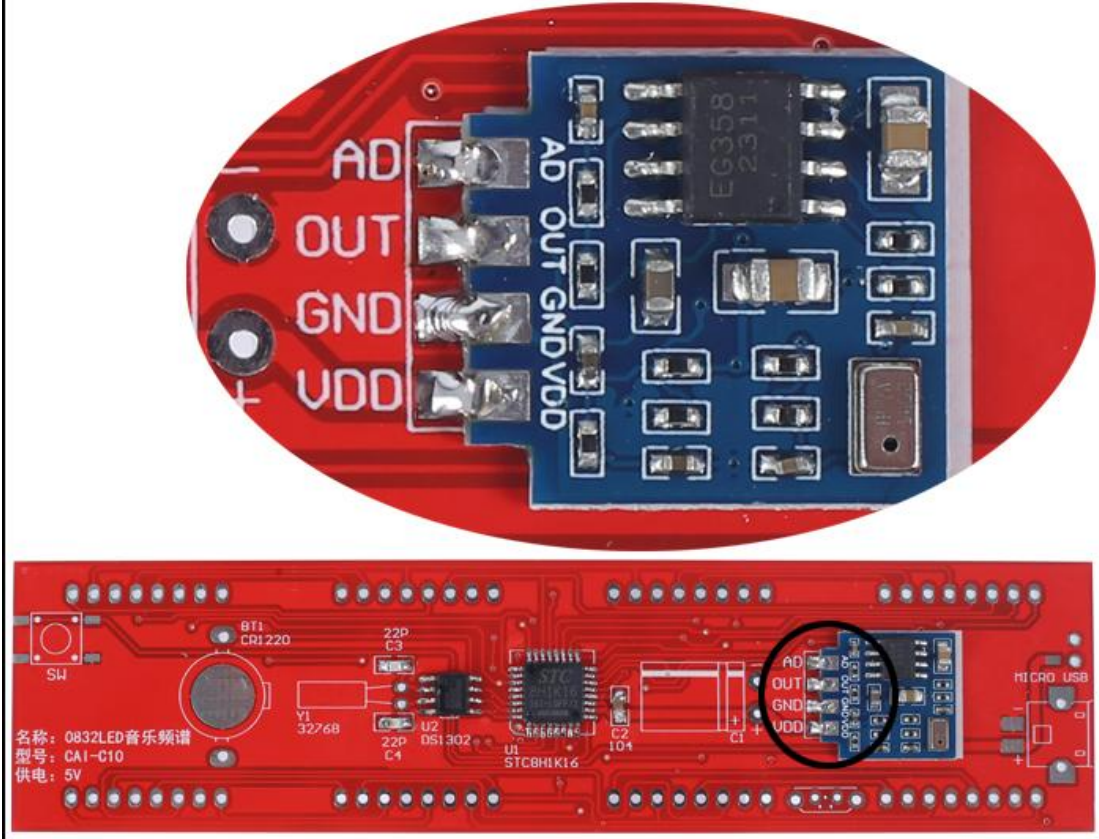

Step 9: Install 1pcs 32.768KHz Crystal Oscillator at Y1 in horizontal.

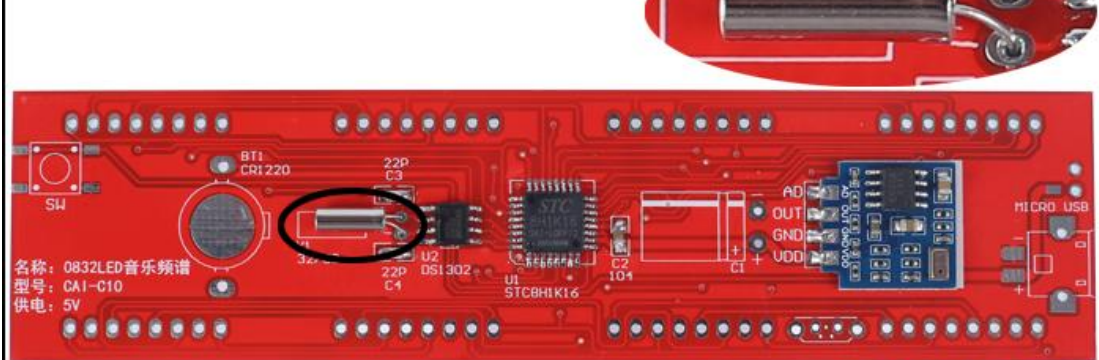

Step 10: Install 1pcs 2Pin Micro USB Socket.

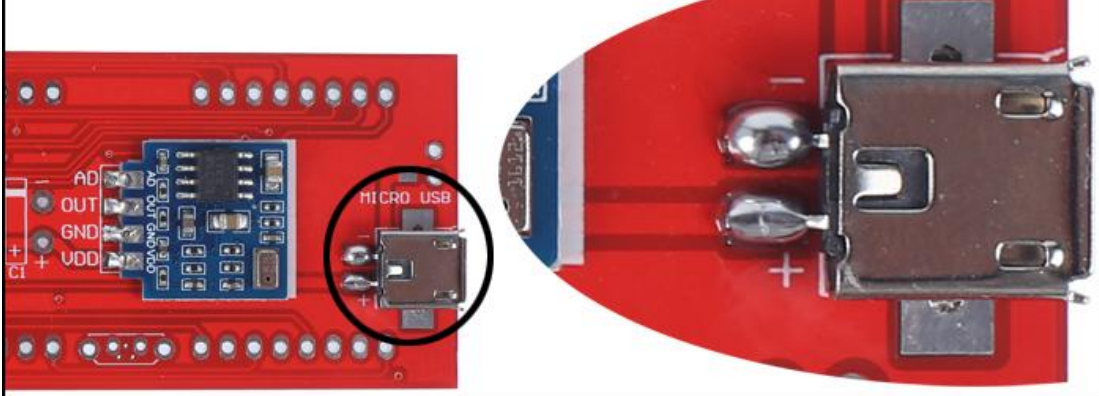

Step 11: Install 1pcs SMD Black Button at SW.

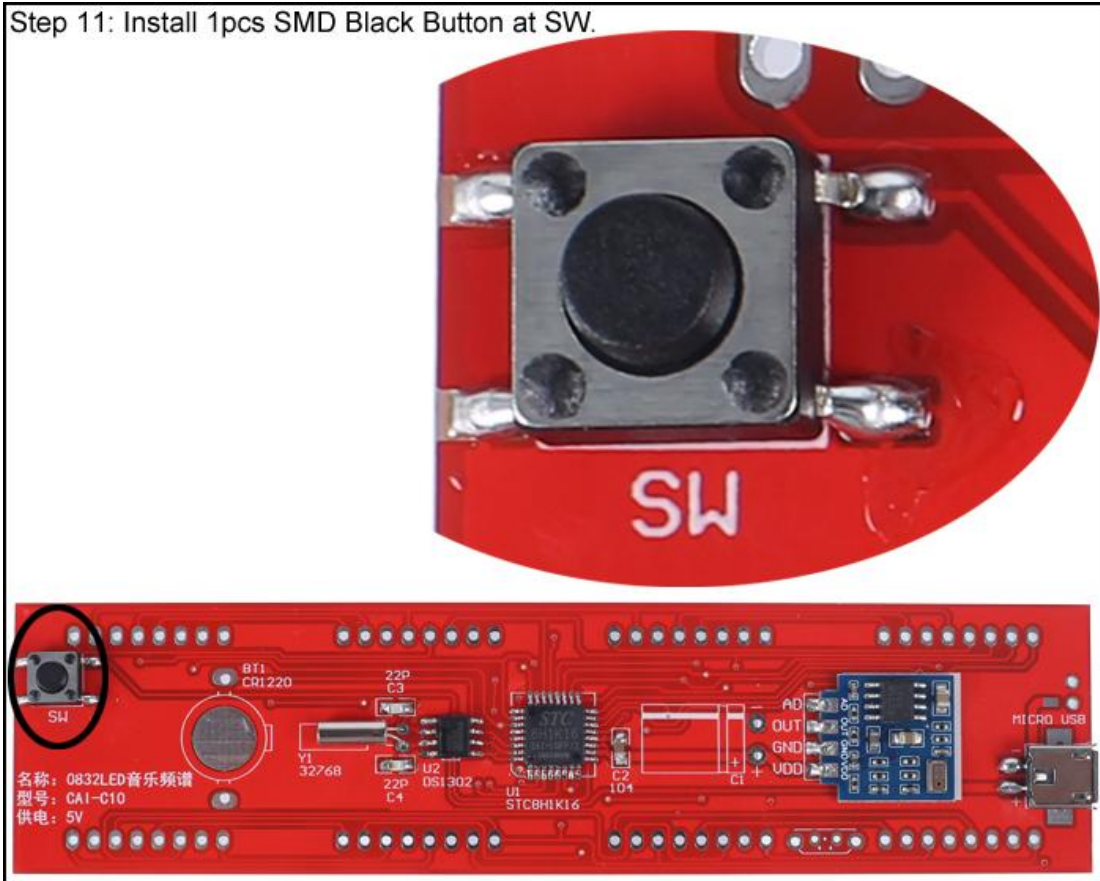

Step 12: Install 1pcs CR1220 Battery Socket. Pay attention to the installation direction.

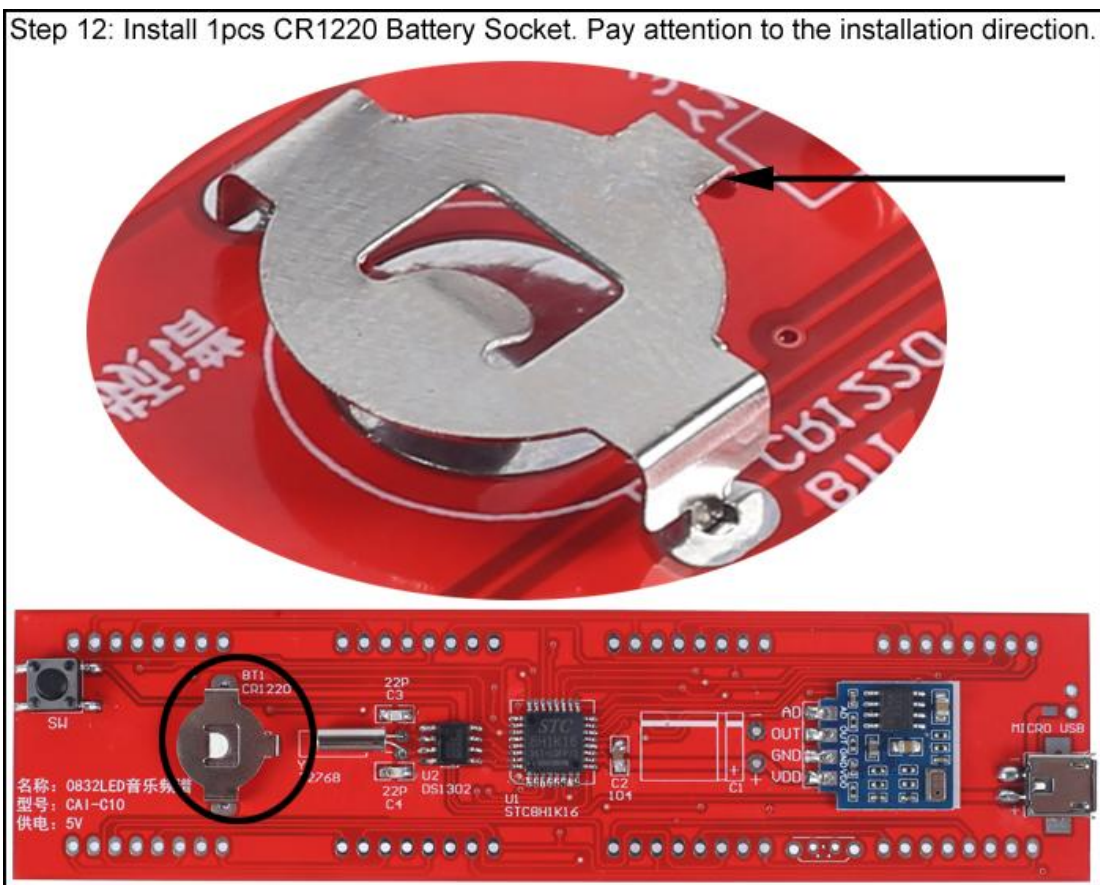

Step 13: Install 1pcs 1000uF Electrolytic Capacitor at C1 in horizontal. The shorter pin is positive pole and connect to ' - ' pad.

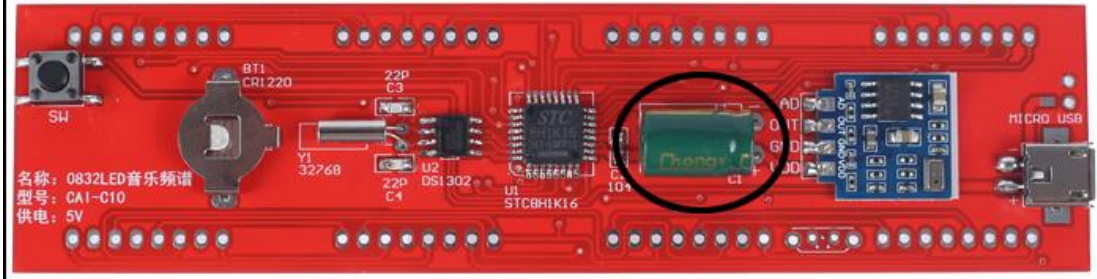
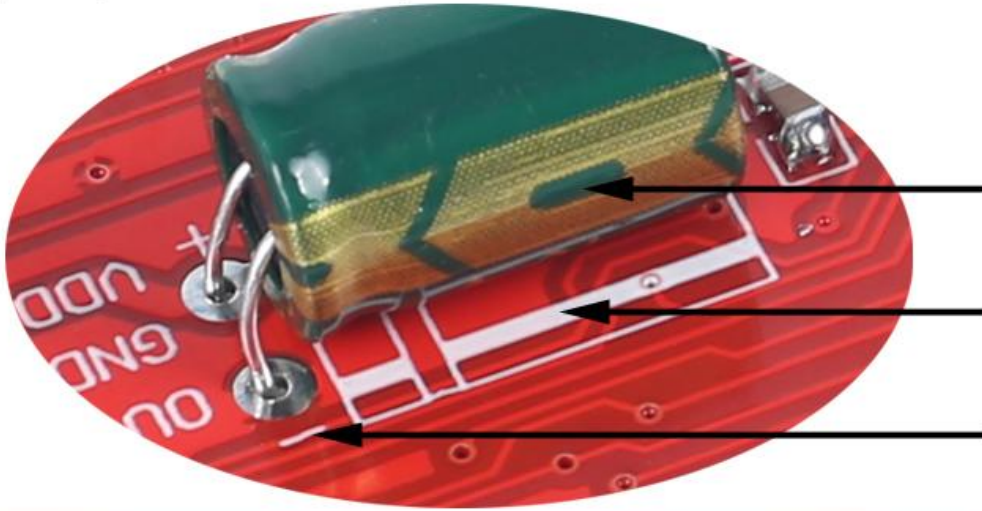

Step 14: Install 1pcs 5Pin Micro USB Socket.



Step 15: Install 8*8 Dot Matrix Screen at LED1-LED4. Screen printings are used to determine direction.

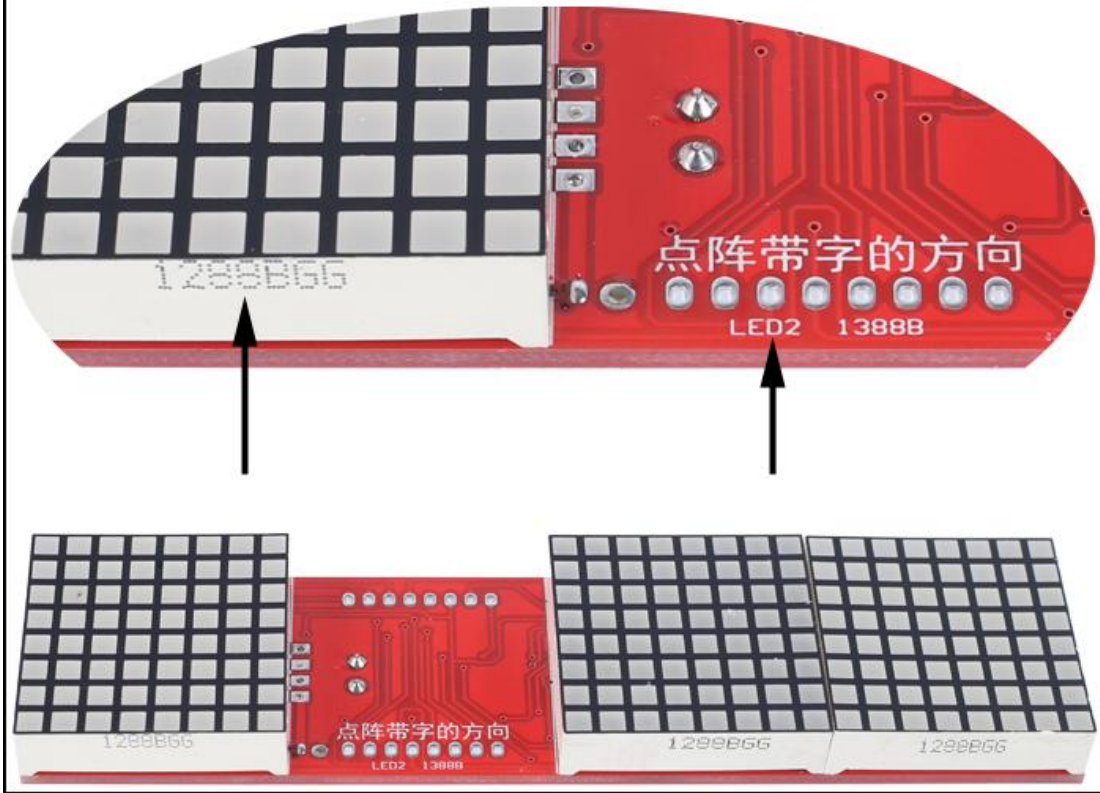

Step 16: Install others 8*8 Dot Matrix Screen by the same direction.



Step 17: Install 1pcs CR1220 battery as shown. Note: The positive electrode of the battery contacts the metal spring of the battery holder.

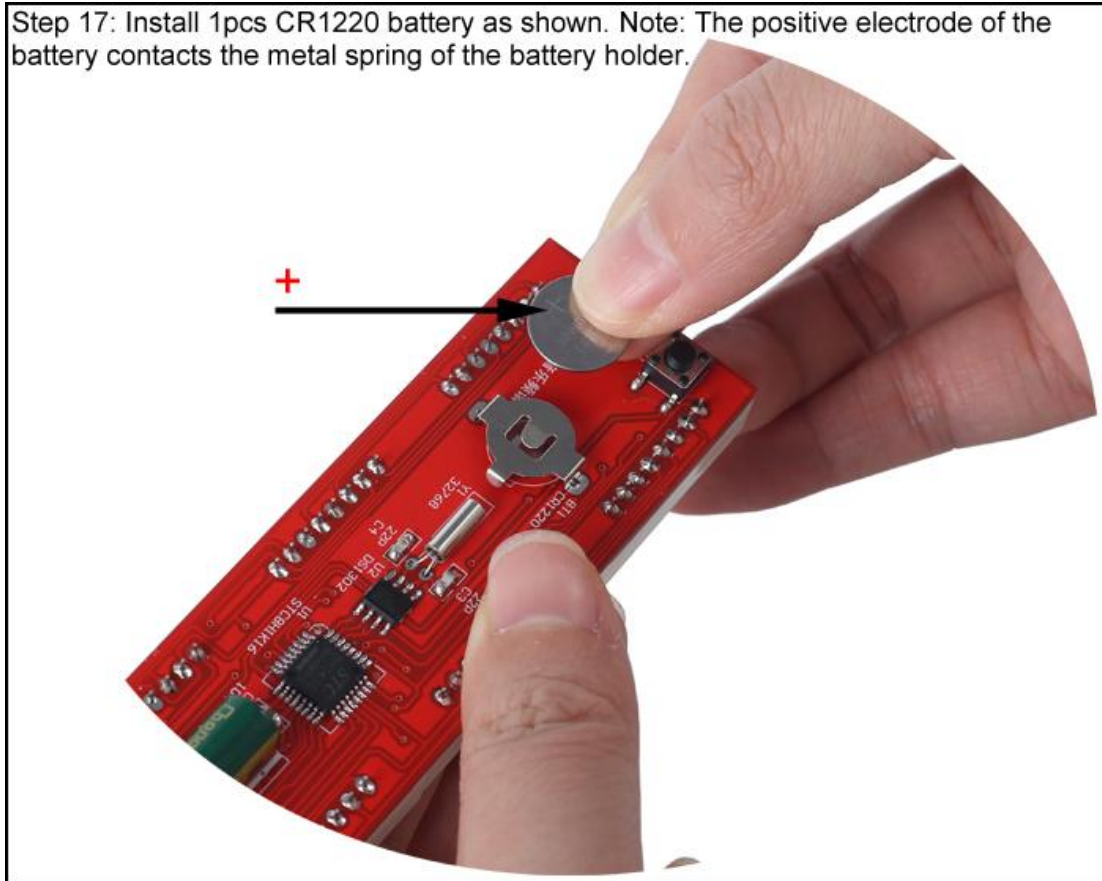

Step 18: Tear off the protective film on the surface of the filter film, being careful that the protective film is very thin and please be patient. You can also avoid using this filter film.

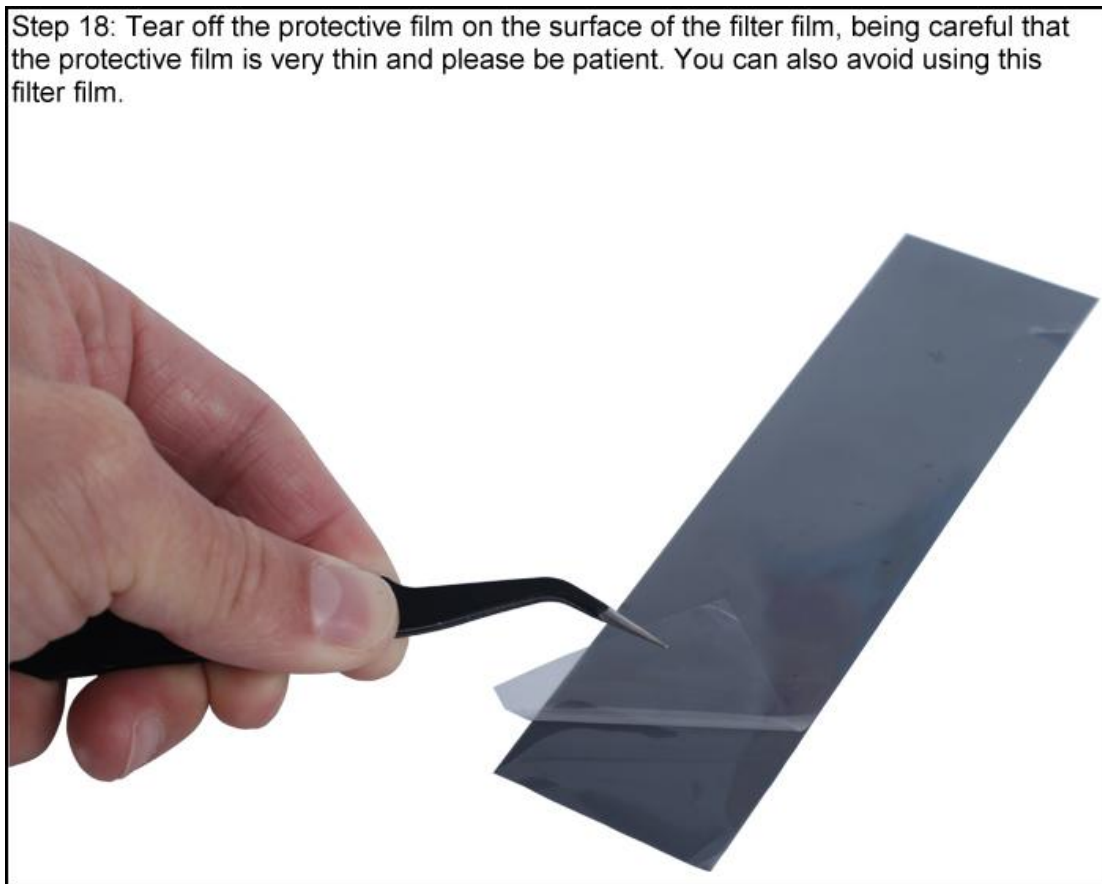

Step 19: Stick the filter film onto the surface of the dot matrix screen and use a small knife to cut off any excess parts. Note: The filter film is not firmly attached, so try to avoid moving it after installation.

