



The Ultimate FM Transmitter (Long Range Spybug)

by [ASCAS](#) on July 13, 2014

Table of Contents

The Ultimate FM Transmitter (Long Range Spybug)	1
Intro: The Ultimate FM Transmitter (Long Range Spybug)	2
Step 1: Gather The Parts	3
Step 2: PCB & Schematics	4
File Downloads	4
Step 3: Print The PCB Layout	4
File Downloads	5
Step 4: Develop The PCB	5
Step 5: Etch The PCB	6
Step 6: Clean The PCB	6
Step 7: Solder The Components	7
Step 8: Construct The Coil	8
Step 9: Adding The Antenna	8
Step 10: Recycle A Battery Clip	8
Step 11: Glue Them Together	9
Step 12: Tune The Transmitter	9
Step 13: Don't Forget To Leave A Comment [Stay Tuned]	9
Related Instructables	10
Advertisements	10
Comments	10



Author: ASCAS ASCAS.com

Hello There! I'm Angelo. I'm 15 and I love to build projects during my pastime! I plan to become an engineer someday and work for a company who innovates new products. _____ My #1 inspiration is my grandpa! He's one of the reasons why I make so many projects. He was a great engineer and the best grandfather that a geek can ever have. When I was in elementary, he used to pick me up from school. We shop at hardware stores before we head home, then build projects together at their garage. When he passed away, I continued my hobby in honor of him. _____ Most of my projects focus on Electronics, Woodworking and Robotics. I've been making projects since I was, now I that I have earned a lot of knowledge through my experience. I now compete in the annual "National Robotics Competition". I earned last year's championship title. I'll be one of our country's representative in this year's International Robotics Olympiad (which will be held at Beijing).

Intro: The Ultimate FM Transmitter (Long Range Spybug)

Have you ever wanted to broadcast your own radio station within the neighborhood? Ever get curious on where people get those "Surveillance Bugs" from spy and action movies? This small and simple FM transmitter is the toy that geeks have always wanted.

FM transmitters can be complicated to build, that's why I'm teaching you how to make a foolproof FM transmitter. There's no need to buy kits, this tutorial includes the PCB layout and the schematics. It has a range of up to 1/4 mile or more. It's great for room monitoring, baby listening and nature research.

It's been a while since I last posted a project. I apologize for the late replies, specially for the projects that I promised of posting. I've been bombarded with TV interviews lately. Well I'm back with a hoard of unpublished guides! :)

Technical Specifications:

- 1/4 Mile Radius Range
- Powered By A 9V Battery
- Lasts For Several Days
- Adjustable 87-108MHz

Please Watch: Celebrating the 1st episode of my new YouTube channel! It's my first time to document a project with videography. I hope you guys enjoy the vid! Please leave a comment below, I would appreciate some advise regarding the video.

Disclaimer: This project is for educational purposes only and is not intended to air/ interfere with present radio channels. Neither site nor I, am liable for careless actions. Please check for the legality before attempting the project within your area.

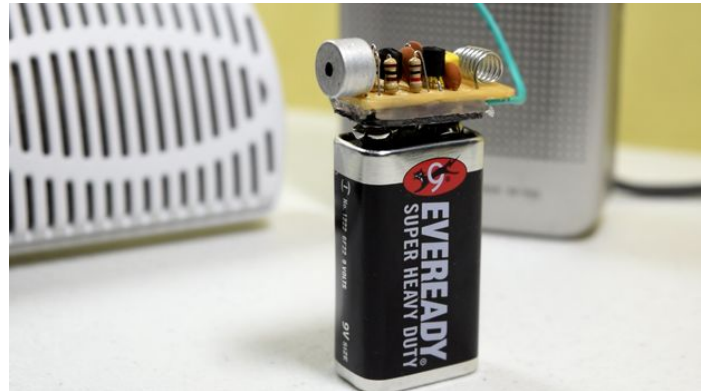

Step 1: Gather The Parts

All of these are available on any branch of RadioShack! :)

MISC:

- Copper Clad PCB/ Perfboard
- Solid Gauge # 18 Wire
- Electret Microphone
- 1/4" Bolt

Transistors:

- 2N3904 General NPN Transistor (2x)

Capacitors:

- 15pF or 40pF Trimmer Capacitor
- 100nF Ceramic Capacitor (2x)
- 10nF Ceramic Capacitor
- 4pF Ceramic Capacitor

Resistors:

- 1M Ohm 1/4w Resistor
- 100K Ohm 1/4w Resistor
- 10K Ohm 1/4w Resistor (3x)
- 1K Ohm 1/4w Resistor
- 100 Ohm 1/4w Resistor

Tools:

- A Pair Of Pliers
- Soldering Iron
- Hot Glue Gun

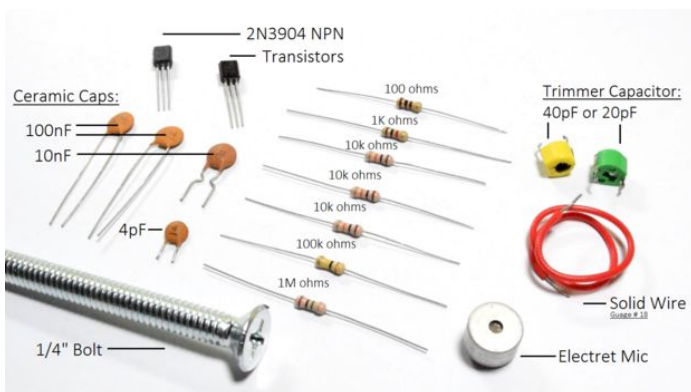

Step 2: PCB & Schematics

I designed a compact PCB layout for Art Swan's miniature FM transmitter circuit using Fritzing. Use this step as your reference for the assembly.

About The Circuit: These is the exact description of Art Swan, the circuit's Author, "This miniature transmitter is easy to construct and can be picked up on any standard FM receiver. It has a range of up to 1/4 mile or more. It's great for room monitoring, baby listening and nature research"

Download Link: <https://docs.google.com/file/d/0BwP5mrDBOvNYaHFnME...>

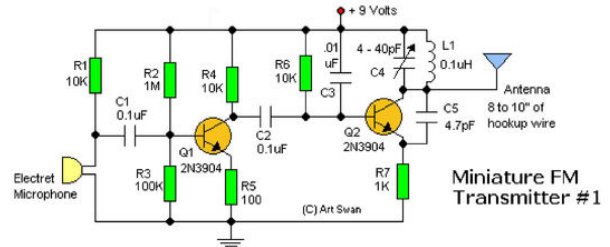
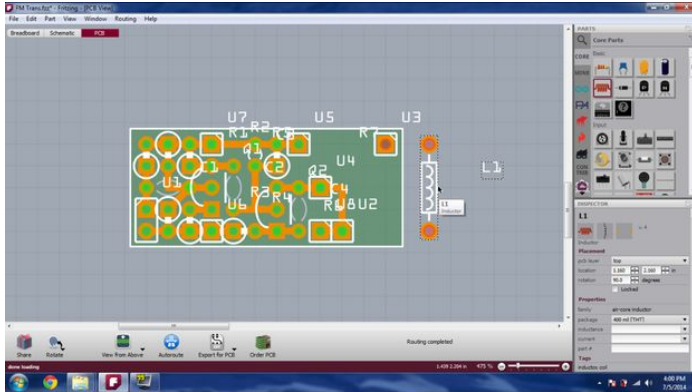

This miniature transmitter is easy to construct and it's transmissions can be picked up on any standard FM receiver. It has a range of up to 1/4 of a mile or more. It is great for room monitoring, baby listening, nature research, etc. L1 is 6 to 10 turns of 22 gauge hook-up wire close wound around a non-conductive 1/4 inch diameter form, such as a pencil. C4 is a small, screw-adjustable, trimmer capacitor. Set your FM receiver for a clear, blank space in the lower end of the band. Then, with a non-conductive tool, adjust this capacitor for the clearest reception. A little experimenting and patience may be in order. Most of the parts values are not critical, so you can try adjusting them to see what happens.

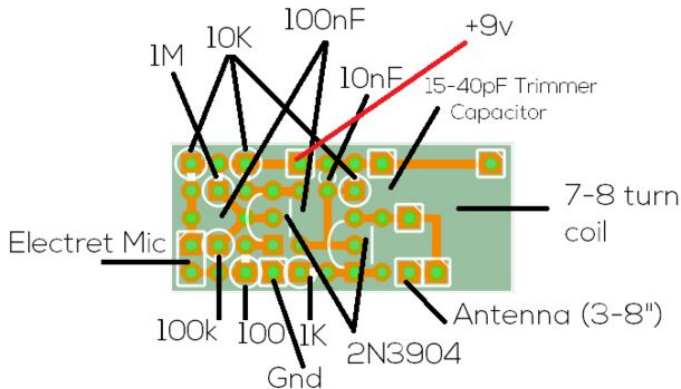

File Downloads



PCB_Layout.pdf (2 KB)

[NOTE: When saving, if you see .tmp as the file ext, rename it to 'PCB_Layout.pdf']

Step 3: Print The PCB Layout

Download the PDF file then print it with your printer's standard setting.

Download Link: <https://drive.google.com/file/d/0BwP5mrDBOvNYaHFn...>

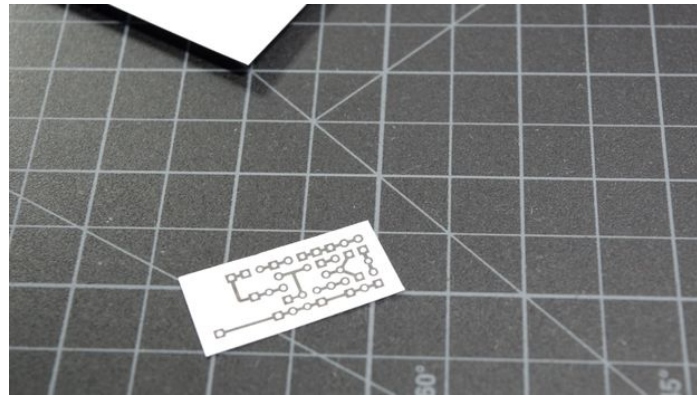
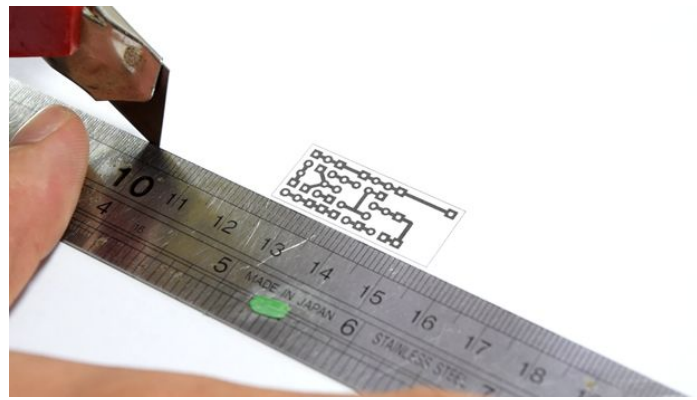

File Downloads



PCB_Layout.pdf (2 KB)

[NOTE: When saving, if you see .tmp as the file ext, rename it to 'PCB_Layout.pdf']

Step 4: Develop The PCB

I'm using something what's called presensitized PCB fabrication, it's different from the toner transfer method. If you're not familiar with presensitized PCBs, better go with the toner transfer method.

Presensitized PCBs: I expose mine directly to a 10W fluorescent lamp for 5:20 minutes then use a dilute solution of Sodium Hydroxide to develop the exposed PCB.

Here's a separate tutorial for the PCB fabrication:





Step 5: Etch The PCB

Pour Ferric Chloride on a plastic tray then start to etch the PCB.

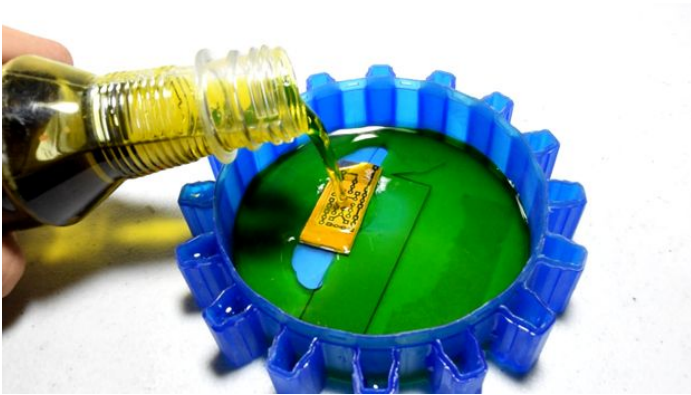

Step 6: Clean The PCB

Use a swab and Acetone to remove the photo-positive layer/ toner.

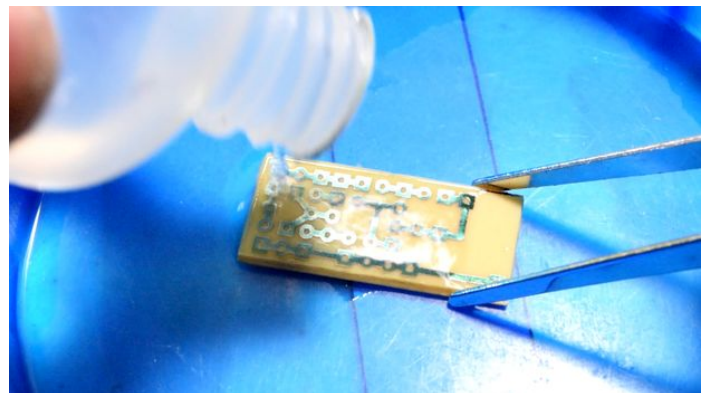
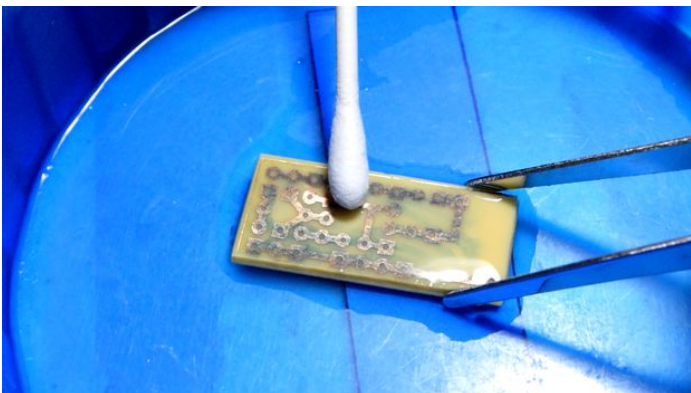

Step 7: Solder The Components

Use step #2 as your reference. Solder the smaller parts first. Start with the resistors, the capacitors, the transistors, the coil, the antenna then the 9V battery clip.

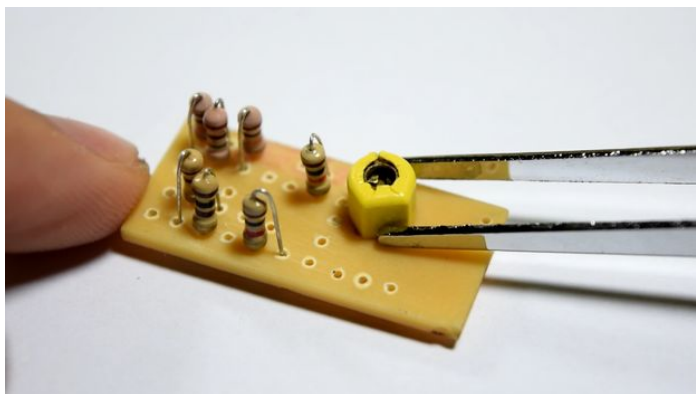
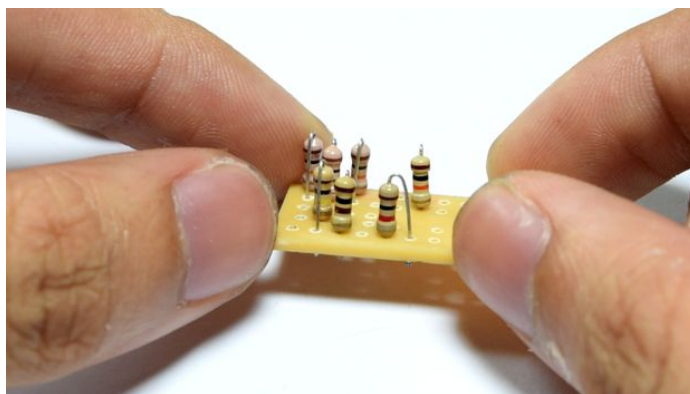
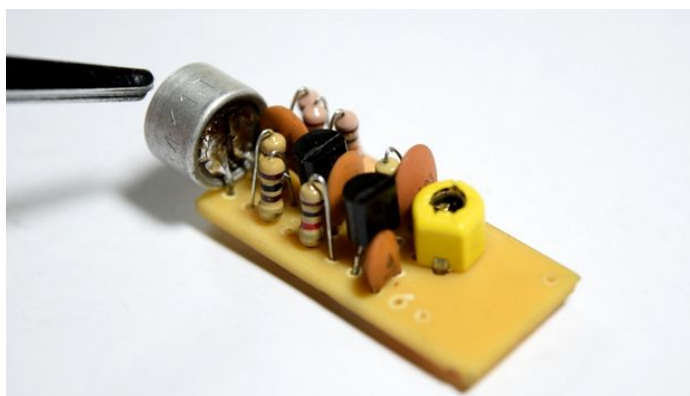
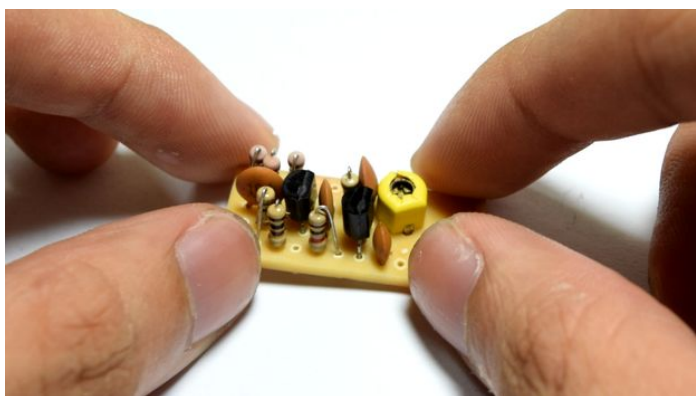
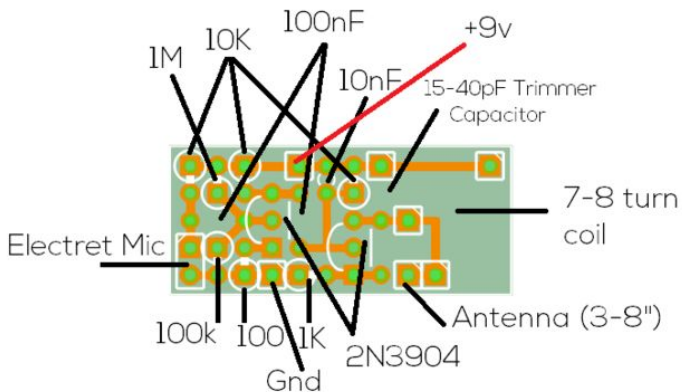
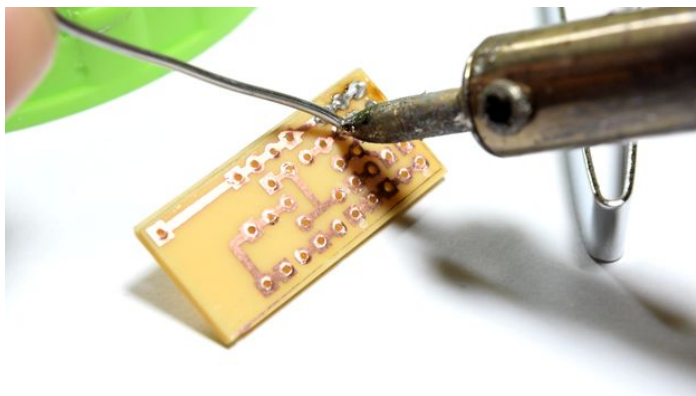

Step 8: Construct The Coil

Strip a solid gauge #18 wire. Use a 1/4" bolt then turn the wire 7-8 times.

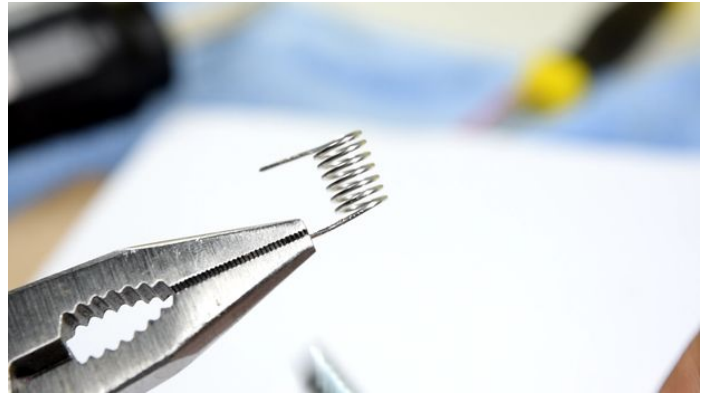

Step 9: Adding The Antenna

Solder a hook-up wire to the antenna pin, it's located on the 2nd transistor's collector pin. Use a maximum of 8 inches and a minimum of 5 inches.

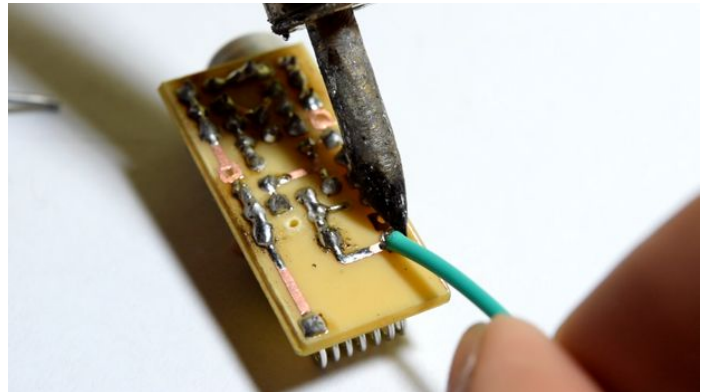
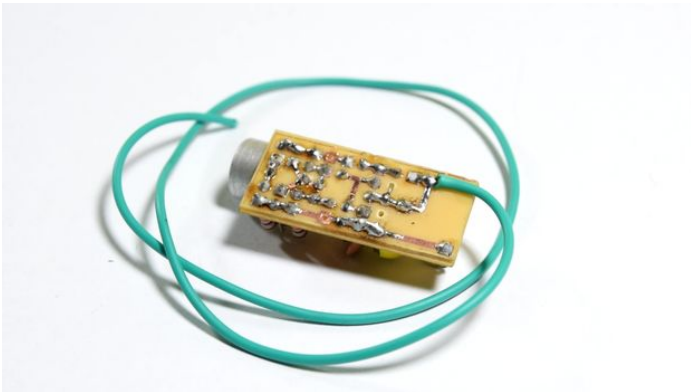

Step 10: Recycle A Battery Clip

The key to this compact transmitter is the ingenious battery clip. You can get one by dismantling a scrap 9v battery.

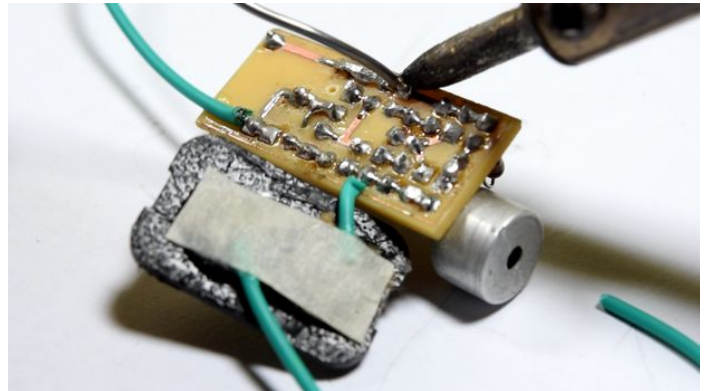
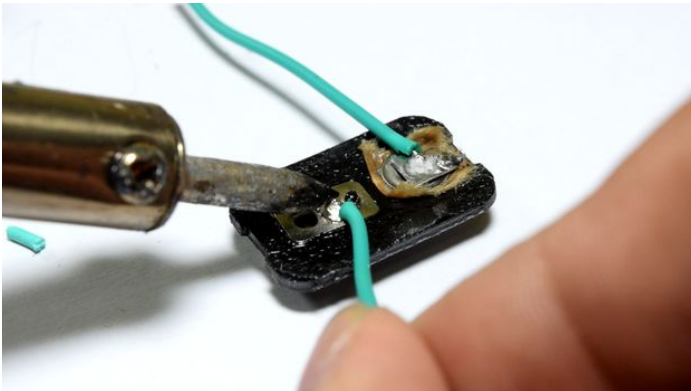

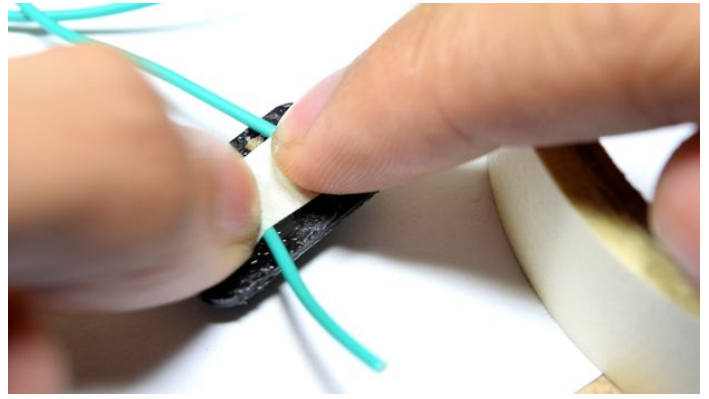

Step 11: Glue Them Together

Apply a generous blob of hot glue to hold the clip and the transmitter circuit together.

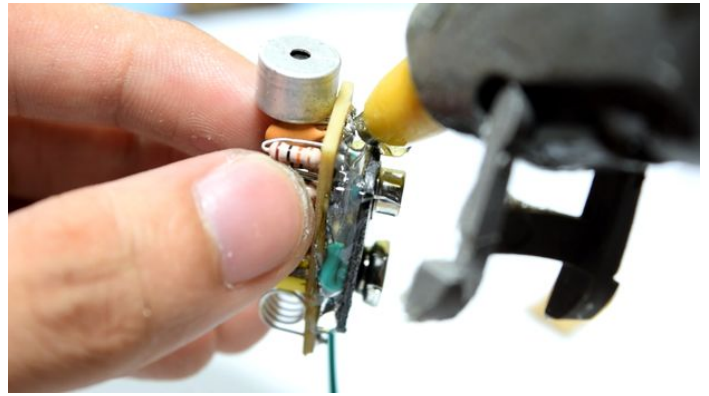
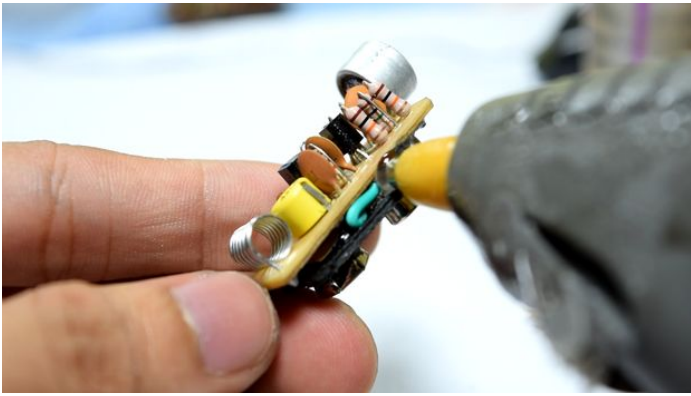

Step 12: Tune The Transmitter

Turn on your radio then tune it to your desired channel frequency. You'll get more range from the vacant channels. Don't touch the coil, just turn the trimmer capacitor until you hear a feedback from the radio.



Step 13: Don't Forget To Leave A Comment [Stay Tuned]

I've always dreamt of starting a continuous DIY video channel. I hope this goes out well. Please don't forget leave a comment below. Thank you!



Related Instructables



Easy and low cost FM transmitter DIY kit (Photos) by buildcircuit



Spy Audio by stive.cool



FM Bug Detector Kit by mpilchfamily



FM Transmitter running off wall power with extended range. by siamonsez



MintyBeam: Bug a room and transmit voice over a laser beam (also a Super Spy Ear/Stethoscope) by drdan152



FM Listening Bug by mpilchfamily

Comments