

ABOUT

I play tennis and need support for my right hand while hitting the tennis racket.

This tennis racket grip glove has been fitted specifically to the dimensions of my right hand.

You can change the dimensions of the tennis racket grip glove in relation to the size that suits you.

All of the measurements in the manual are in millimeters.

The strap, clip, velcro and the fabric are all standard materials that can be found universally.

B.O.M - outside

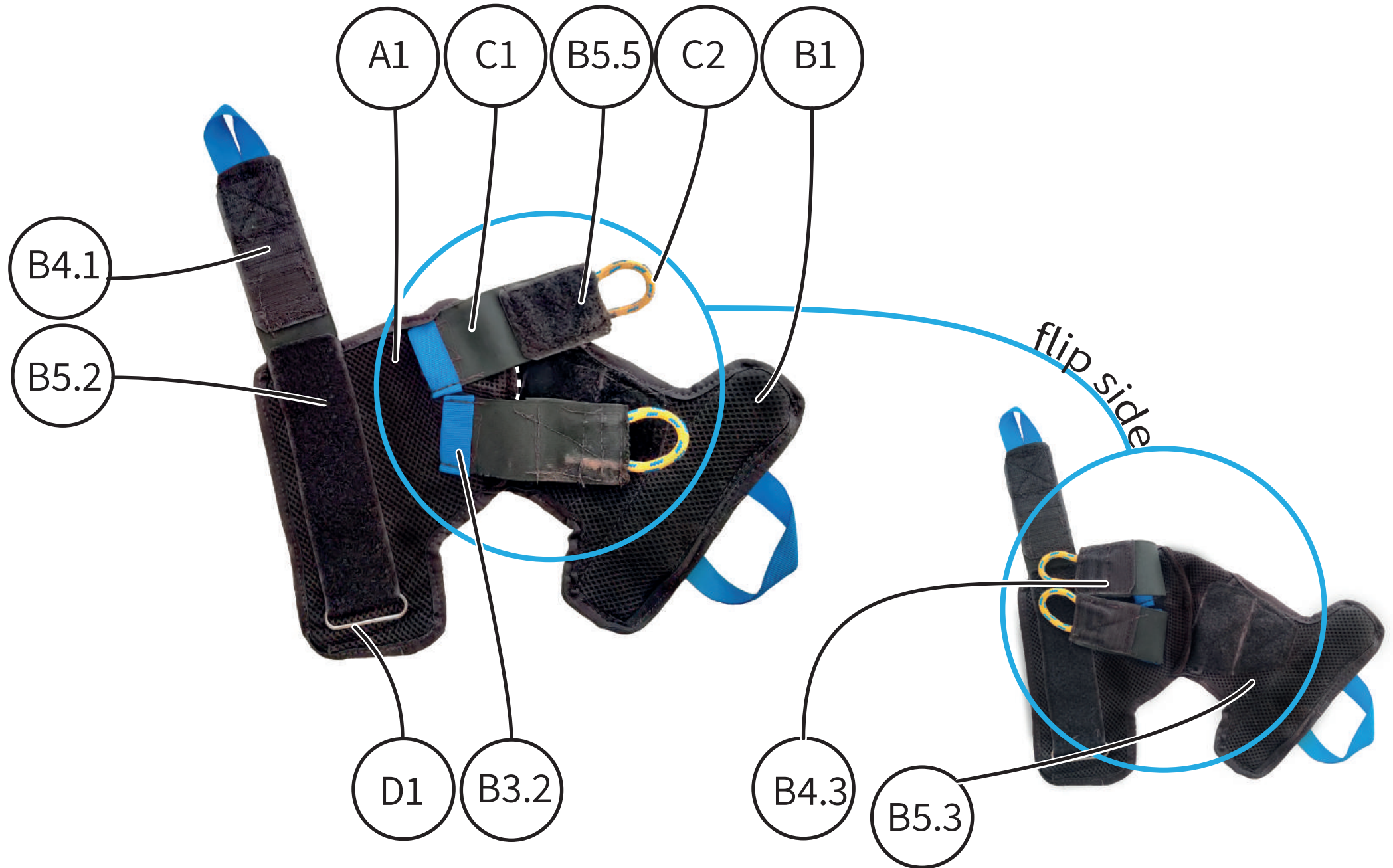



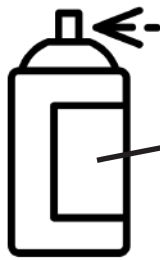
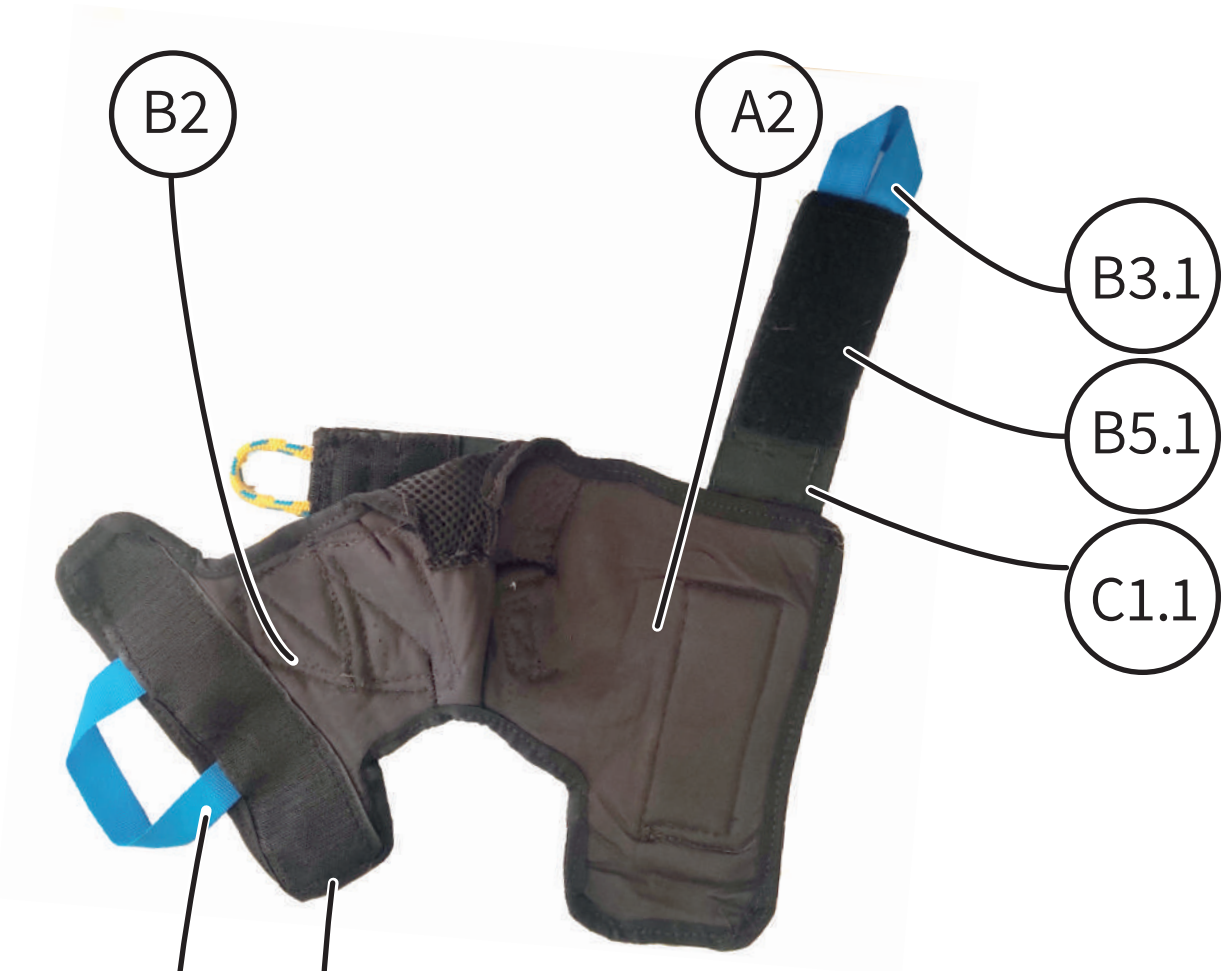















B.O.M - inside



- E1
- B3.4
- B4.2

B.O.M - Supplies

PN	Picture	Part name	overall dimensions (mm)		source(links)	materiel	manufacturin technology
			width	height			
A1+B1		Back hand cover	52CM	52CM		Mesh Fabric	Lamination and sewing
A2+B2		Back hand cover lining	52CM	52CM		Lycra fabric	Lamination and sewing
B3		Blue Pull handle	2CM / 3/4"	45CM		Nylon Webbing Strap	Sewing
B1		Male velcro	7.5CM / 3"	44CM		Nylon Velcro	Sewing
B2		Female velcro	7.5CM / 3"	54CM		Nylon Velcro	Sewing
C1		Tightening straps	5CM / 2"	30CM		Elastic Band with Heavy Stretch	Sewing
C2		yellow pull handle	0.5CM	32CM		Diamond Braided Polypropylene Rope	Sewing
D1		Metal Buckles ring	1.5cm	5cm		Metal Rectangle Buckles ring Square	Sewing

PN	Picture	Part name	overall dimensions (mm)		source(links)	materiel	manufacturin technology
			width	height			
E1		Glue spray				Glue spray	Lamination

DIMENSIONS

Ilay's right hand

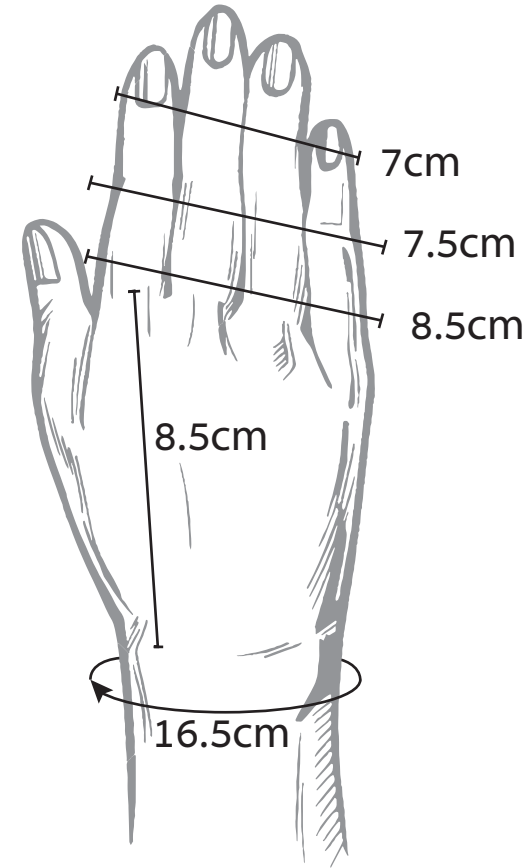
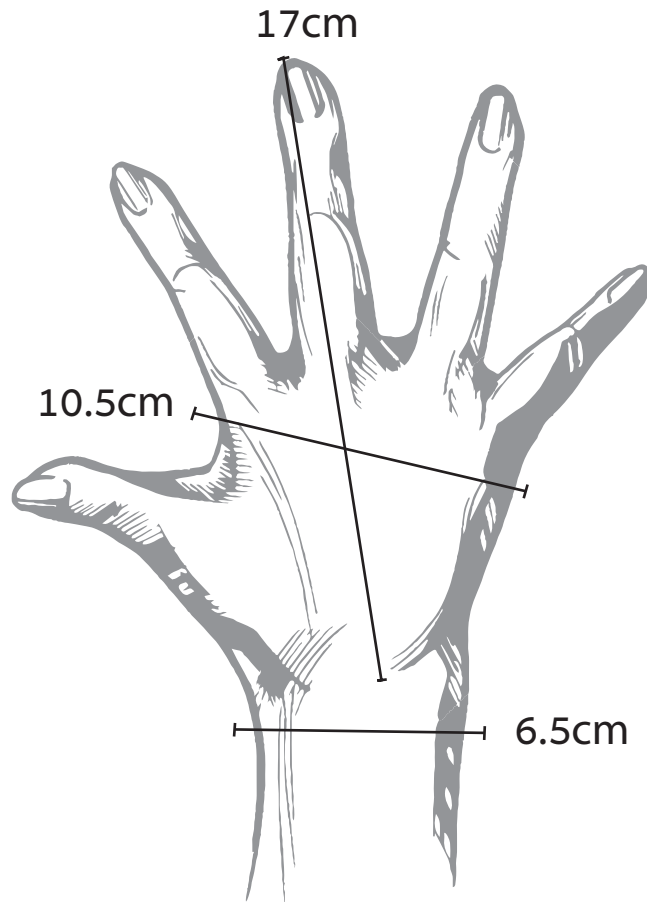

Cutting and preparation for lamination and sewing

FOLD 

SEW 

SEWED 

CUT 

PREPARATION FOR LAMINATION

A1 + A2 - Cut 27*27 cm

A1

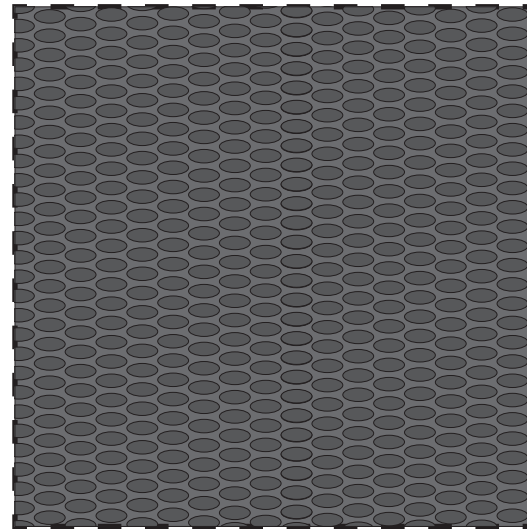

A2

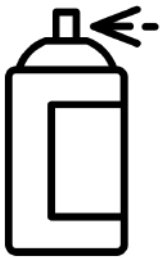

E1- Spray with the glue spray at the whole section of the internal side of the fabric in both parts - A1 and A2 .
Attach the two pieces together.
Wait about two hours for complete drying.
A1 and A2 are now one part.

A1A2

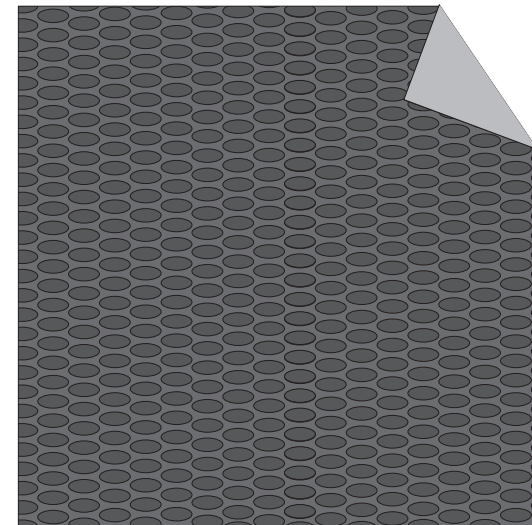

FOLD - - - - - SEW - - - - - SEWED - - - - - CUT - - - - -

PREPARATION FOR SEWING

A1A2 - Cut section

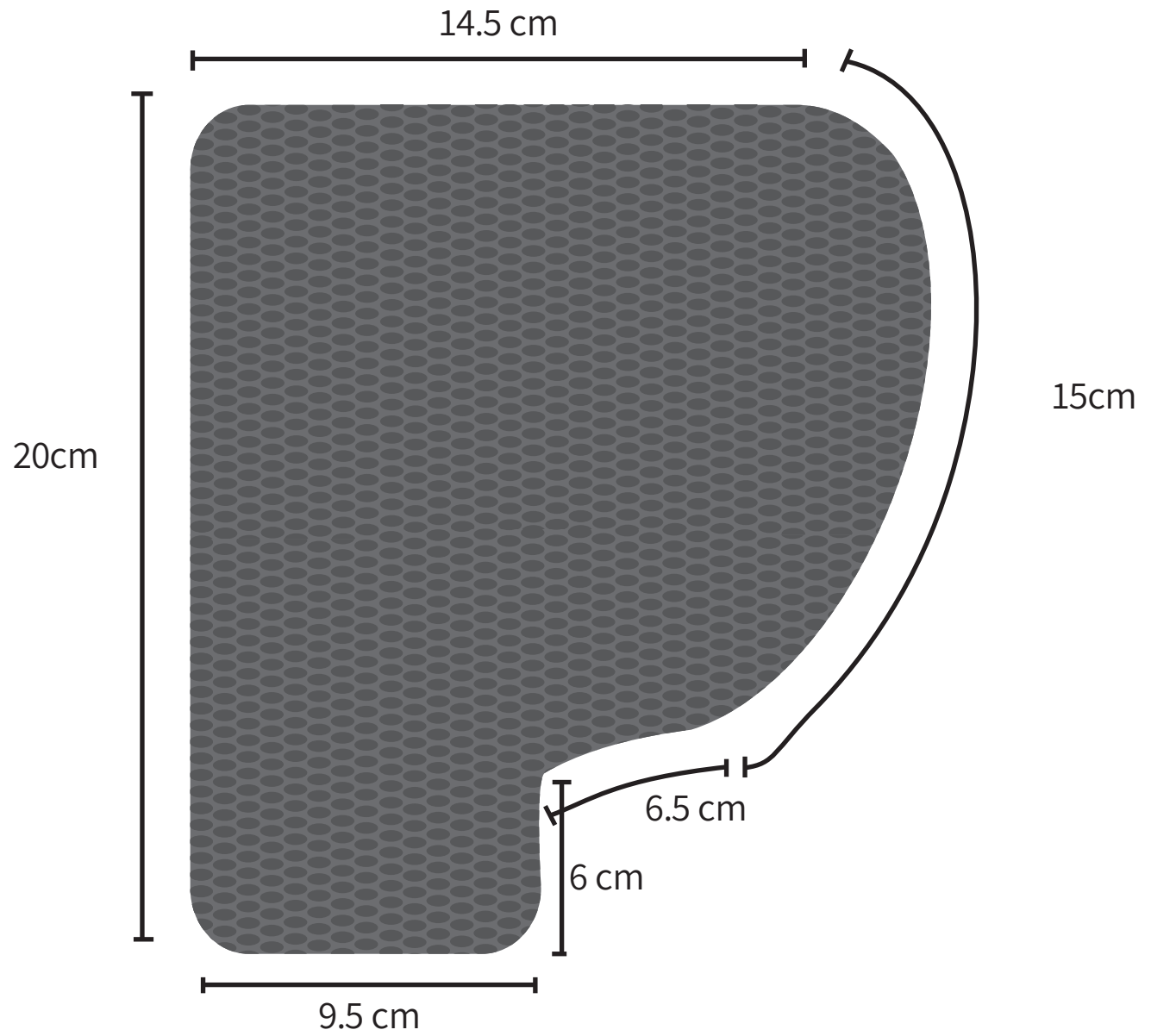
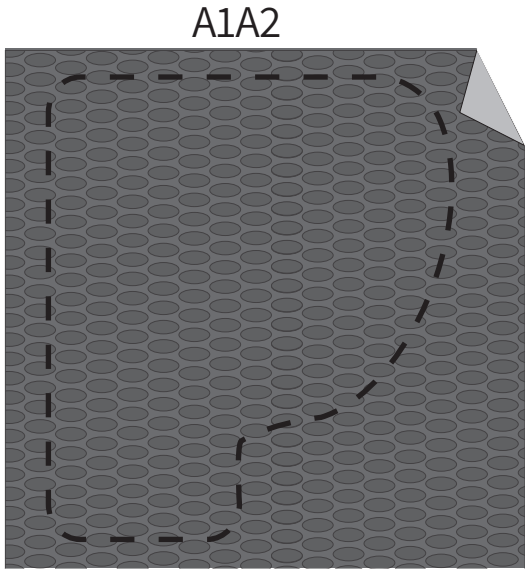

FOLD - - - - - SEW - - - - - SEWED - - - - - CUT - - - - -

PREPARATION FOR LAMINATION

B1 + B2 - Cut 25*25 cm

B1

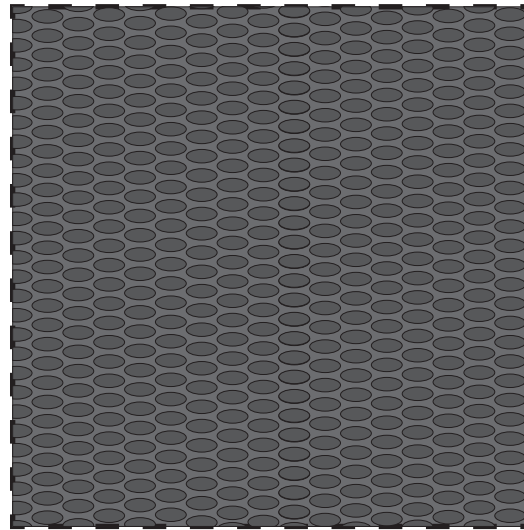

B2

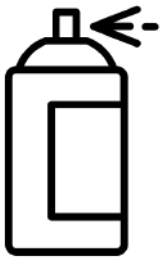

E1- Spray with the glue spray at the whole section of the internal side of the fabric in both parts - B1 and B2 .

Attach the two pieces together.

Wait about two hours for complete drying.

B1 and B2 are now one part.

B1B2

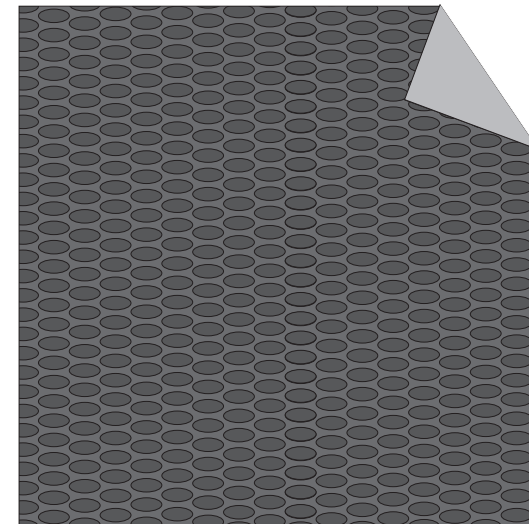

FOLD - - - - -

SEW - - - - -

SEWED - - - - -

CUT - - - - -

PREPARATION FOR SEWING

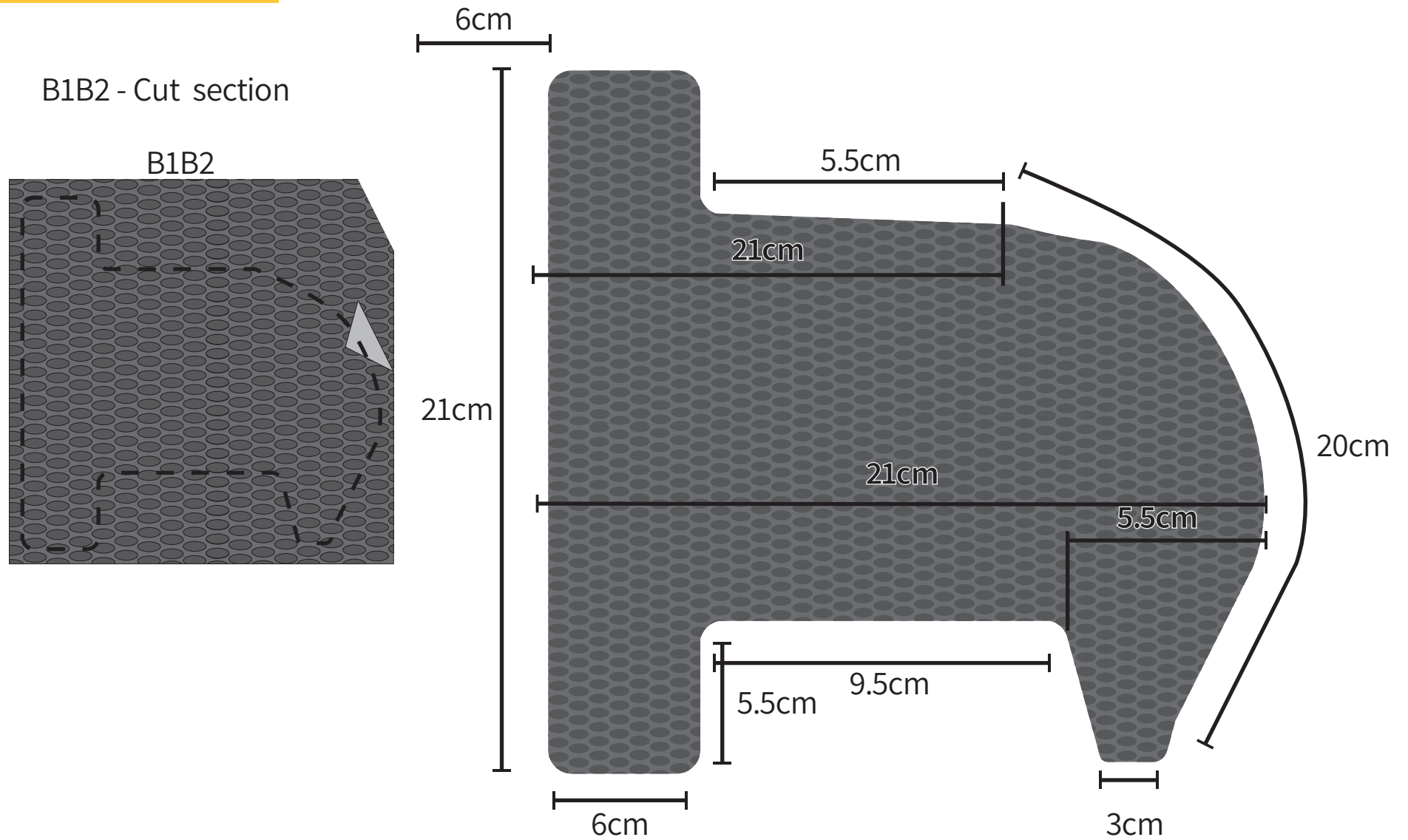

FOLD

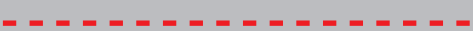

SEW



SEWED

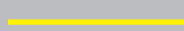

CUT



PREPARATION FOR SEWING

C1 -Tightening straps - Cut section

3 NEW PARTS:

C1.1

C1.2

C1.3

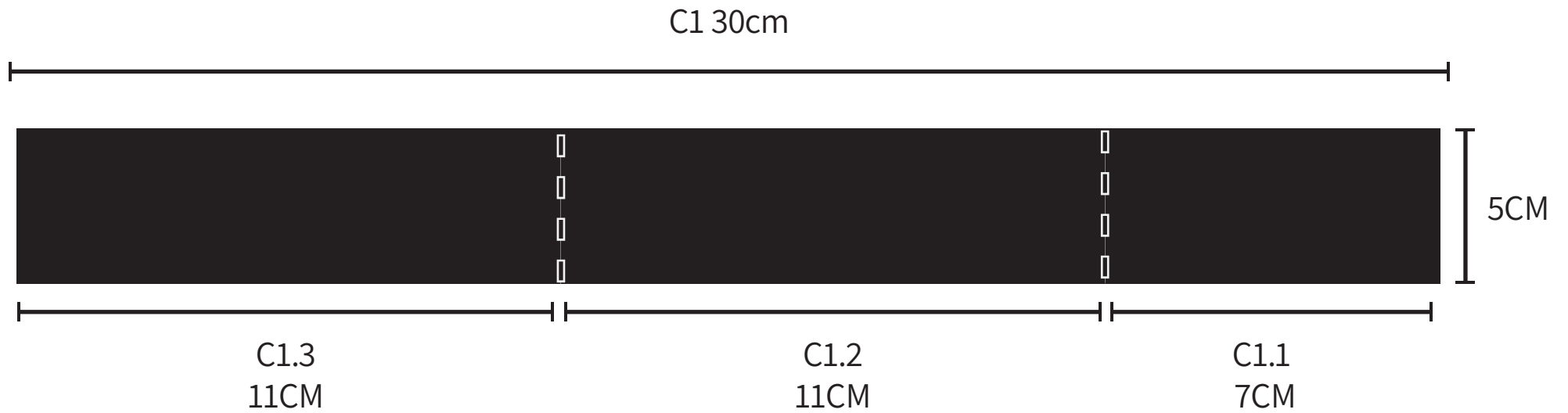

PREPARATION FOR SEWING

B3 -Blue pull handle -
Cut section

4 NEW PARTS:

B3.1

B3.2

B3.3

B3.4

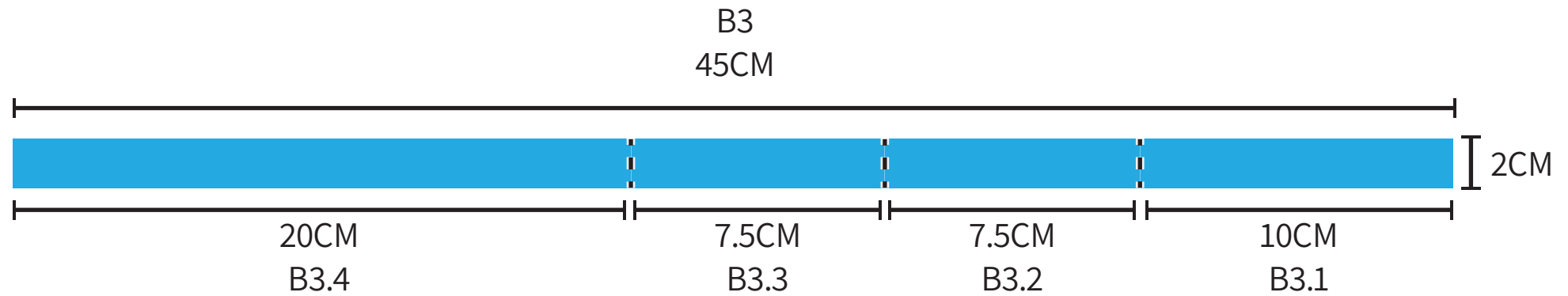

FOLD 

SEW 

SEWED 

CUT 

PREPARATION FOR SEWING

B4 - Male velcro - Cut section

4 NEW PARTS:

B4.1

B4.2

B4.3

B4.4

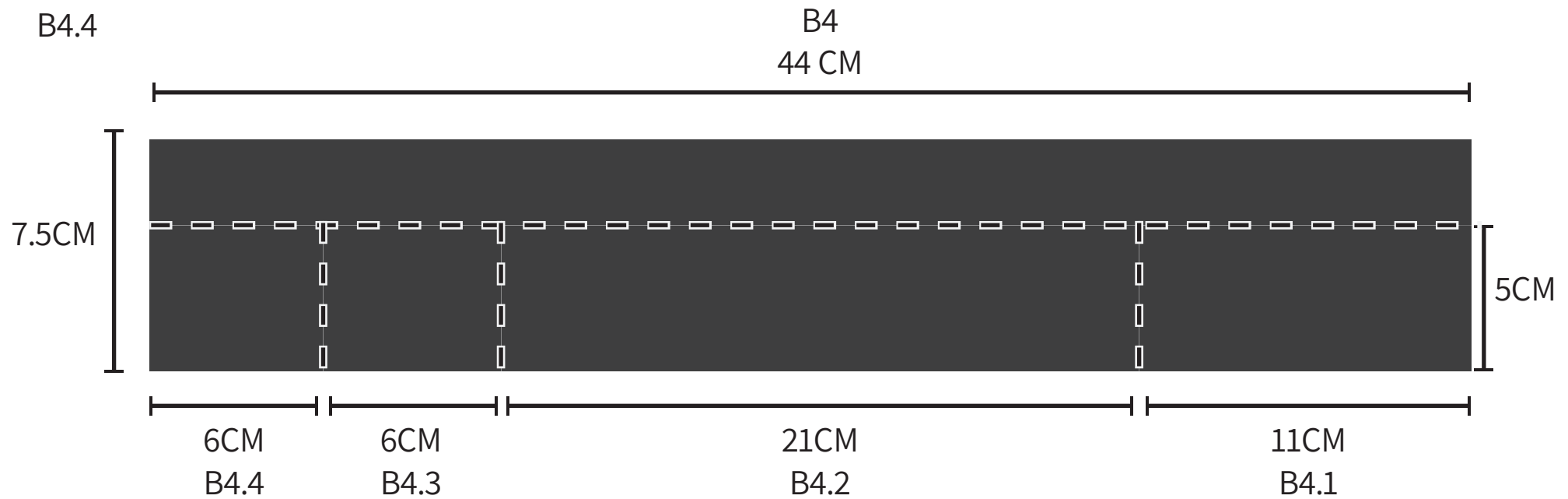

FOLD

SEW

SEWED

CUT

PREPARATION FOR SEWING

B5 - Female velcro - Cut section

5 NEW PARTS:

B5.1

B5.2

B5.3

B5.4

B5.5

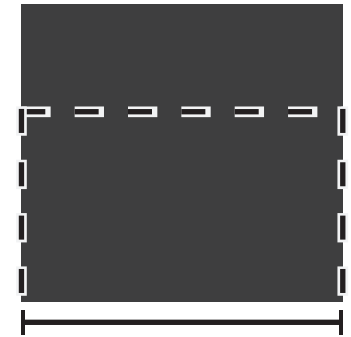

6CM

B5.5

B4
48 CM

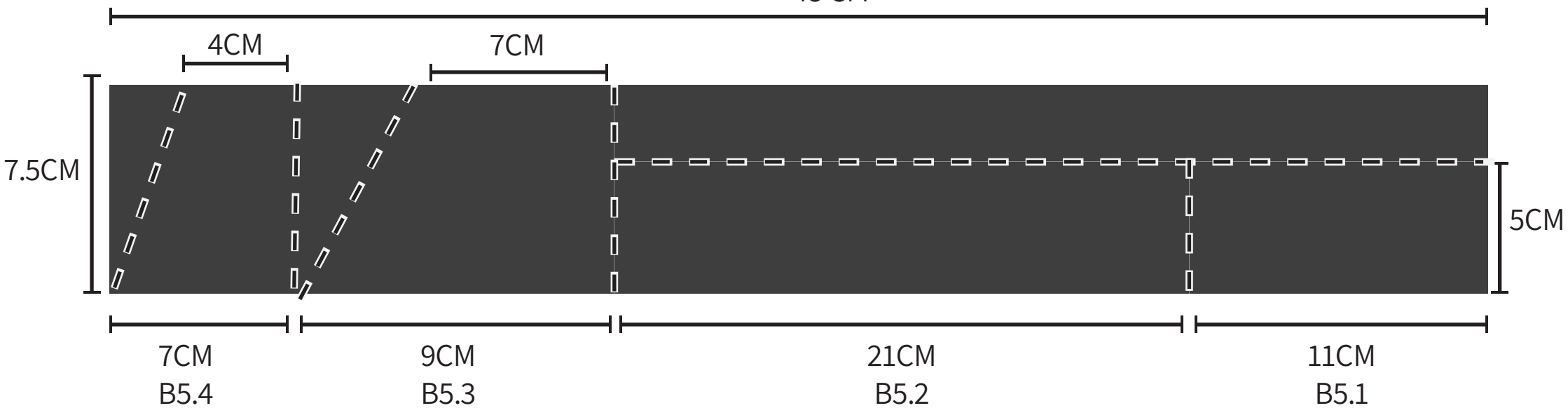

FOLD

SEW

SEWED

CUT

PREPARATION FOR SEWING

C2 - Yellow pull handle
cut section

2 NEW PARTS:

C2.1

C2.2

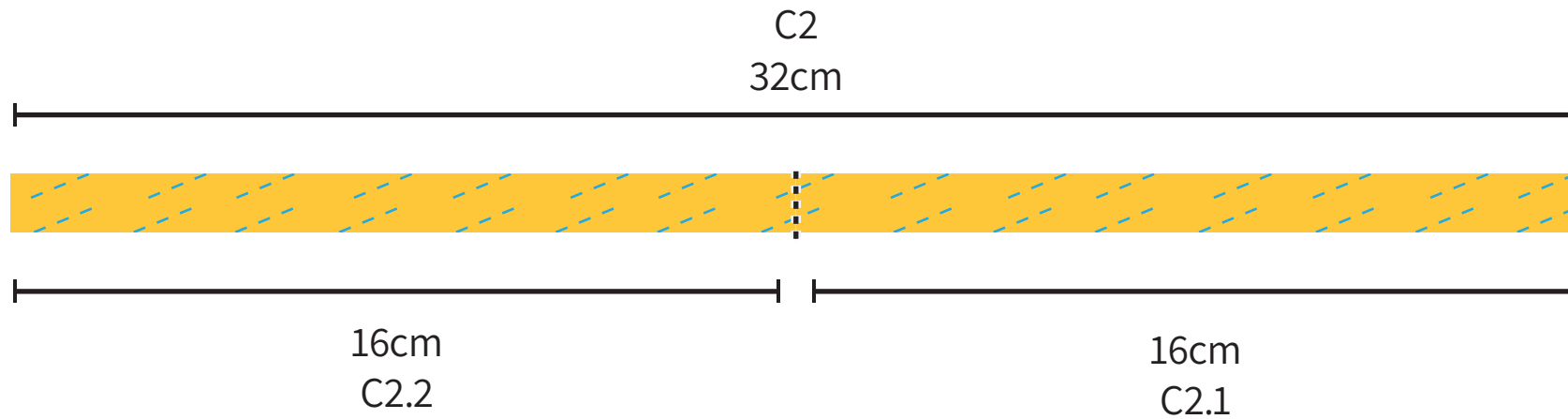

FOLD - - - - -

SEW - - - - -

SEWED ———

CUT - - - - -

PREPARATION FOR SEWING AND SEWING

step 1

B5.2 + D1-

Take the ring buckle(D1) and pull through the female velcro strap(B5.2).



step 2

B5.2 + D1-

Fold 3 cm of the female velcro strap(B5.2) above the buckle ring .
NOT ON THE VELCRO SIDE



step 3

B5.2 + D1-

Sew the velcro strap through the buckle ring.
B5.2 and D1 are now one part.



FOLD - - - - - SEW - - - - - SEWED - - - - - CUT - - - - -

SEWING

step 1

Take the parts in this order:

B5.2+D1

C1.1

B4.1

B3.1

B5.1

A1A2

step 2

Put 2cm C1.1 above
B5.2+D1.

NOT ON THE VELCRO
SIDE.

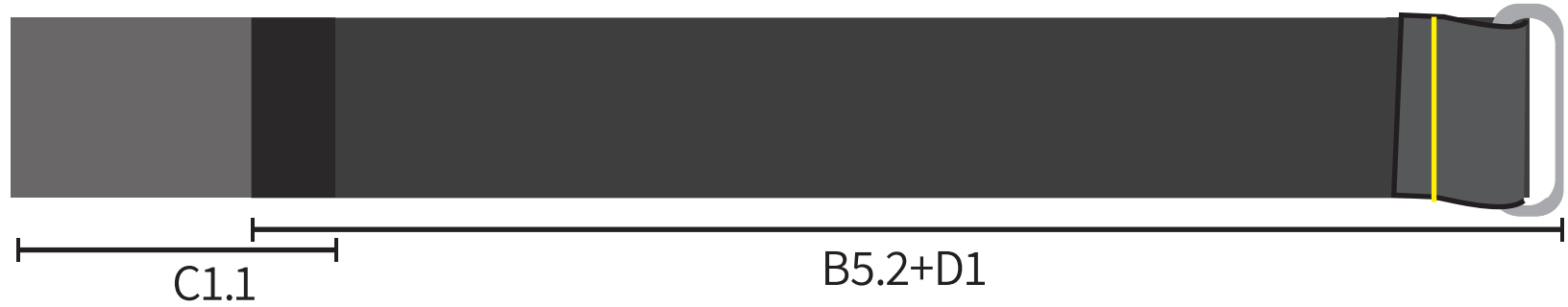

step 3

Sew these parts.
B5.2 and D1 are now
one part.

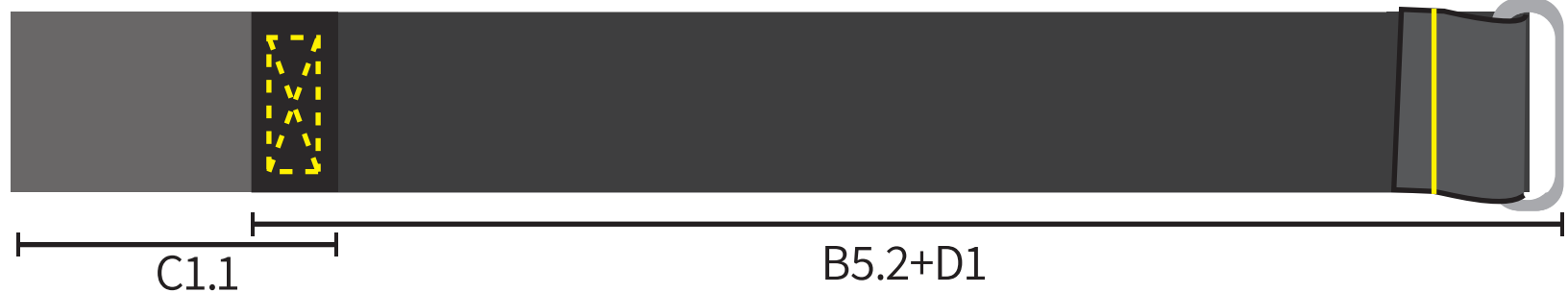

step 4

flip sides.
FEMALE VELCRO SIDE UP.



FOLD - - - - - SEW - - - - - SEWED - - - - - CUT - - - - -

SEWING

step 5

Sew 2cm B4.1 above C1.1
FEMALE AND MALE VELCRO SIDE UP



step 6

Put 2cm B3.1 above B 4.1
ON VELCROS SIDE



step 7

flip side
FEMALE VELCRO SIDE DOWN



FOLD - - - - - SEW - - - - - SEWED - - - - - CUT - - - - -

SEWING

step 8

Put 2cm B3.1 above
B4.1 and fold

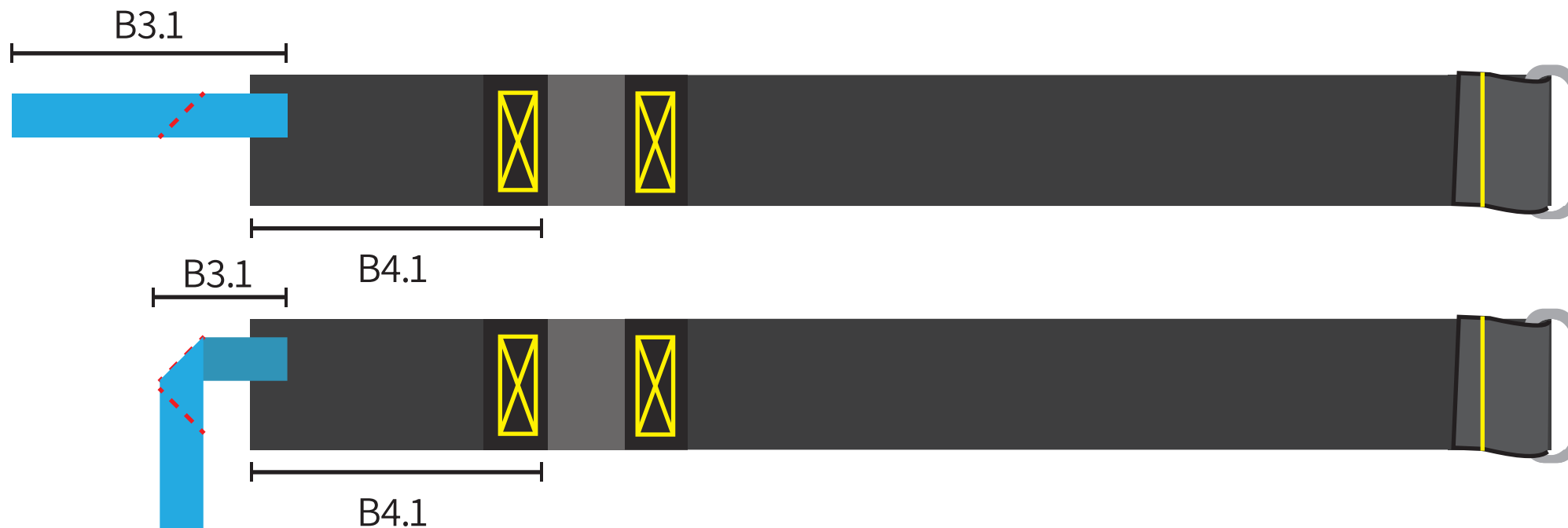

step 9

sew the blue strap



FOLD - - - - - SEW - - - - - SEWED - - - - - CUT - - - - -

SEWING

step 10

sew female velcro B5.1
above the blue strap.
THE VELCRO STRAP IS
READY.



step 11

flip sides.



FOLD - - - - -

SEW - - - - -

SEWED - - - - -

CUT - - - - -

SEWING

step 12

Sew the velcro strap to
A1A2.

OBOVE THE MESH SIDE

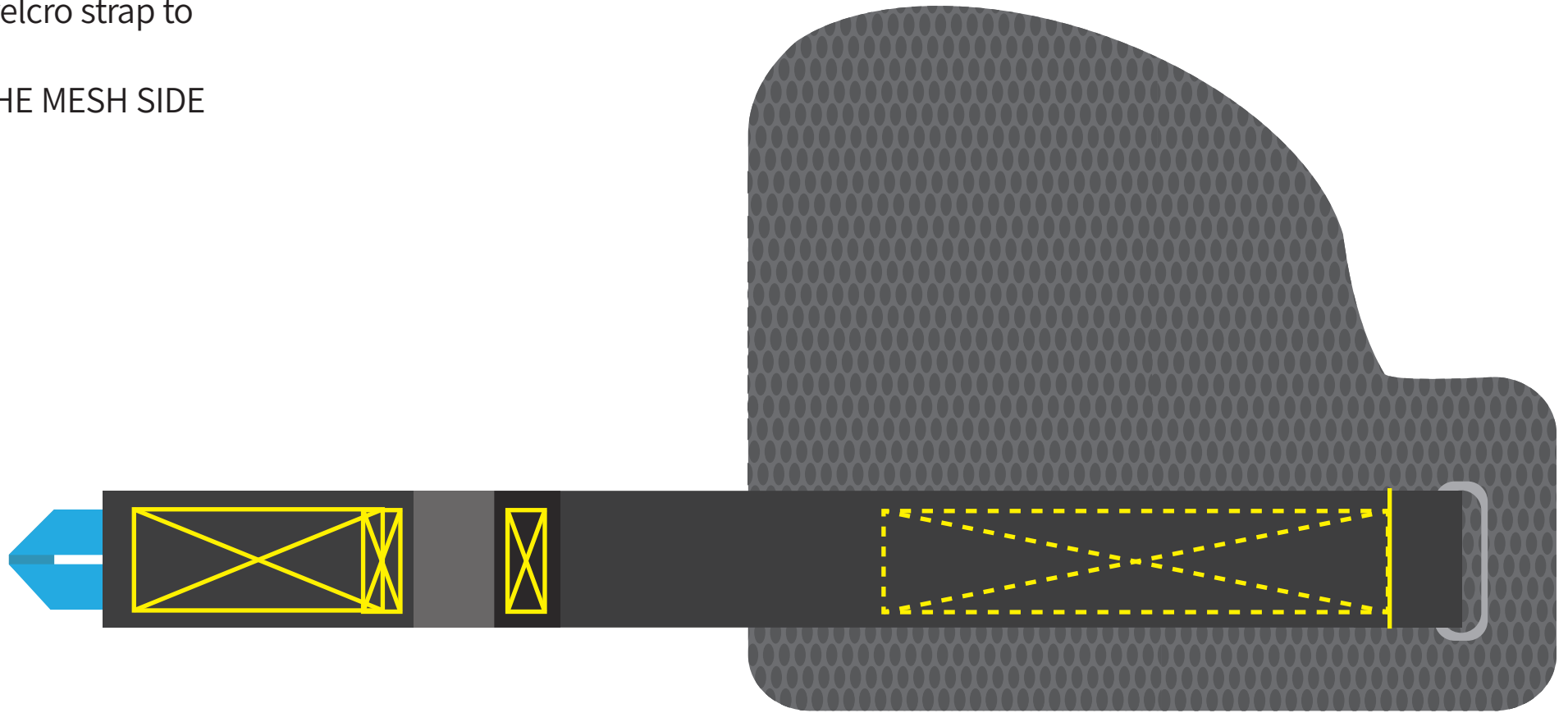

FOLD - - - - -

SEW - - - - -

SEWED ———

CUT - - - - -

**SEWING
B1B2**

STEP 1

Flip side B1B2.

LYCRA FABRIC SIDE UP.



FOLD 

SEW 

SEWED 

CUT 

SEWING
B1B2

STEP 2

Fold B3.4 and sew above B1B2

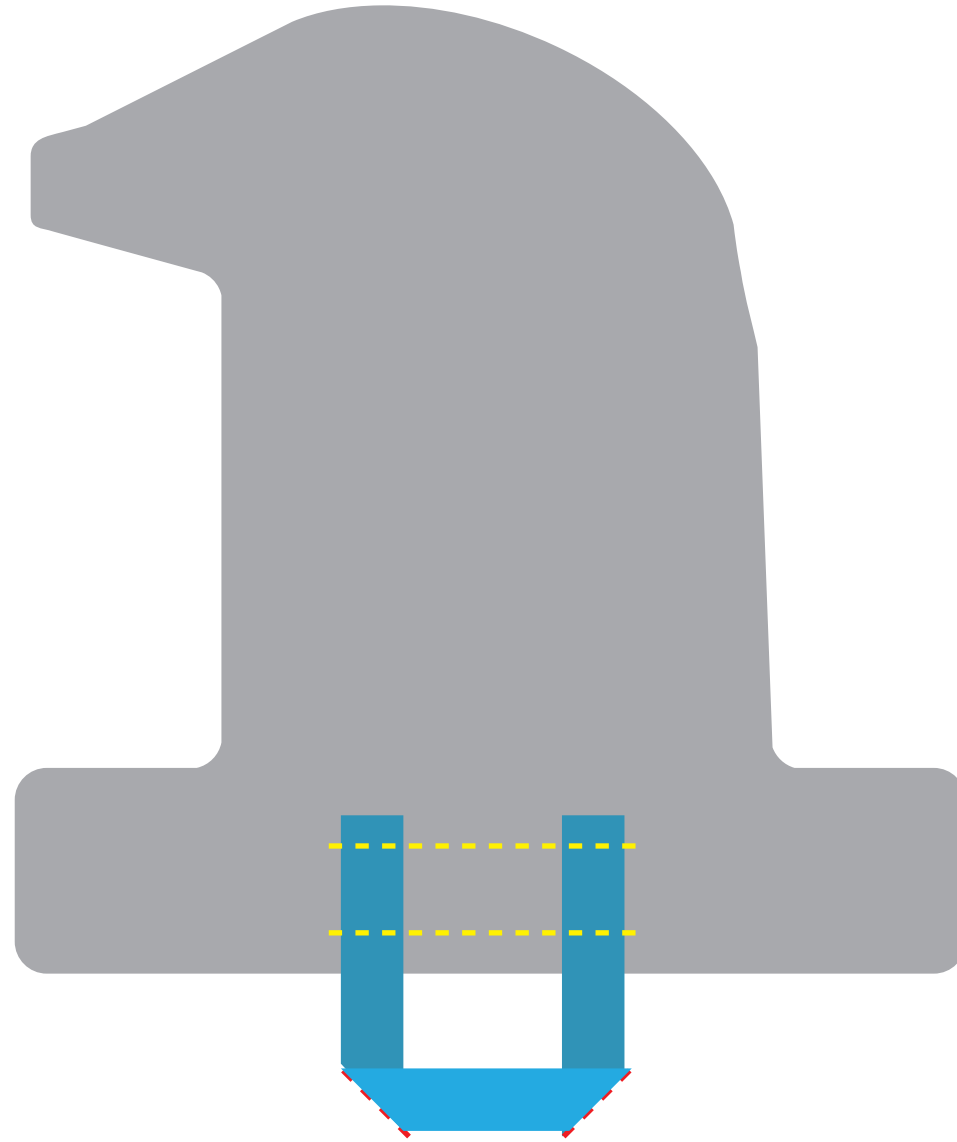
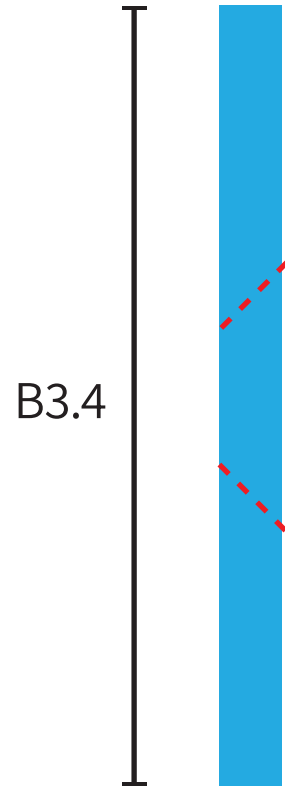

FOLD - - - - -

SEW - - - - -

SEWED ———

CUT - - - - -

SEWING
B1B2

STEP 3

Sew male velcro B4.2 above B1B2.

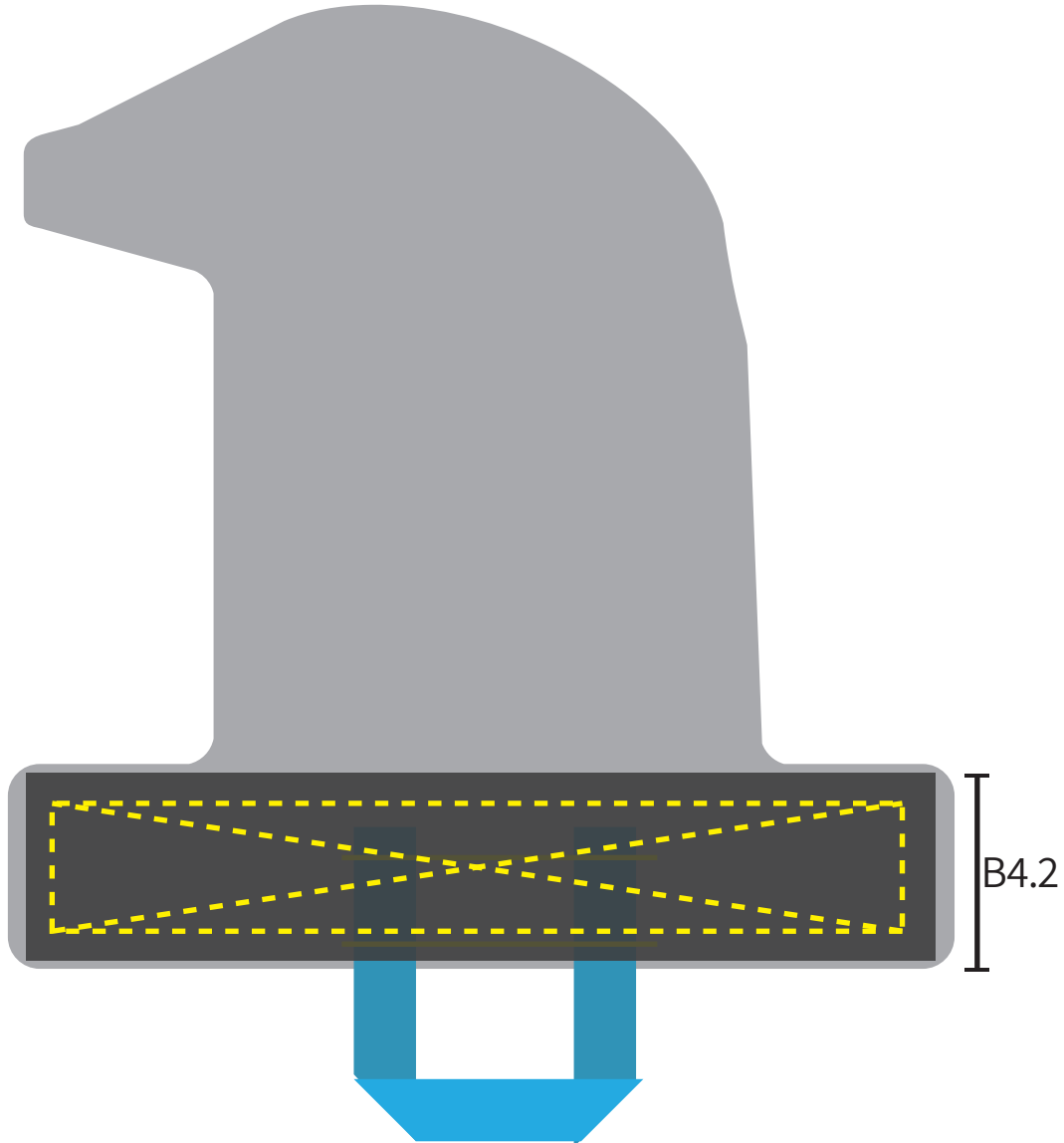

STEP 4

Fold and sew the finger holder

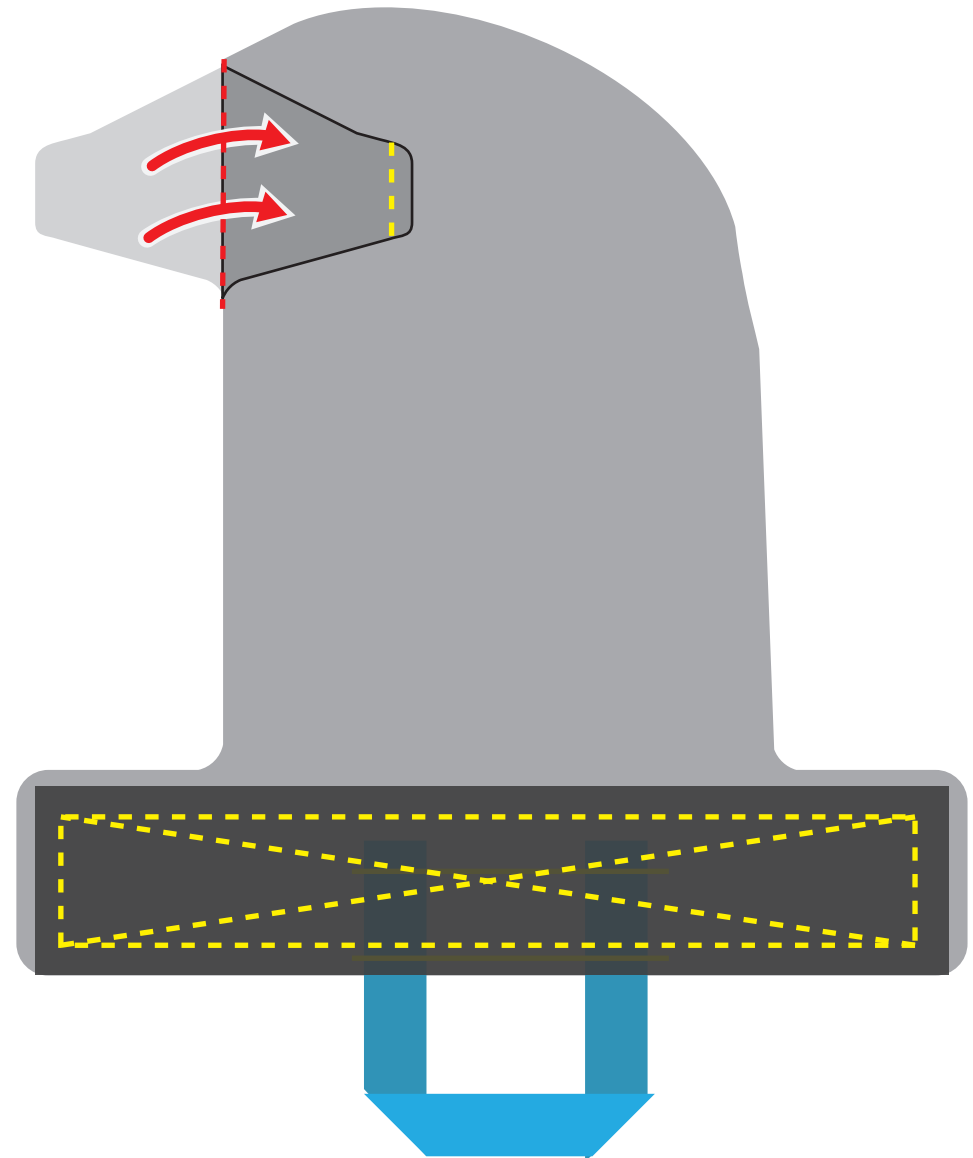

FOLD - - - - - SEW - - - - - SEWED - - - - - CUT - - - - -

SEWING B1B2

STEP 1

Flip B1B2.

Mesh fabric side up and sew
female velcro B5.4 and B5.5 .
PART B1B2 IS READY.

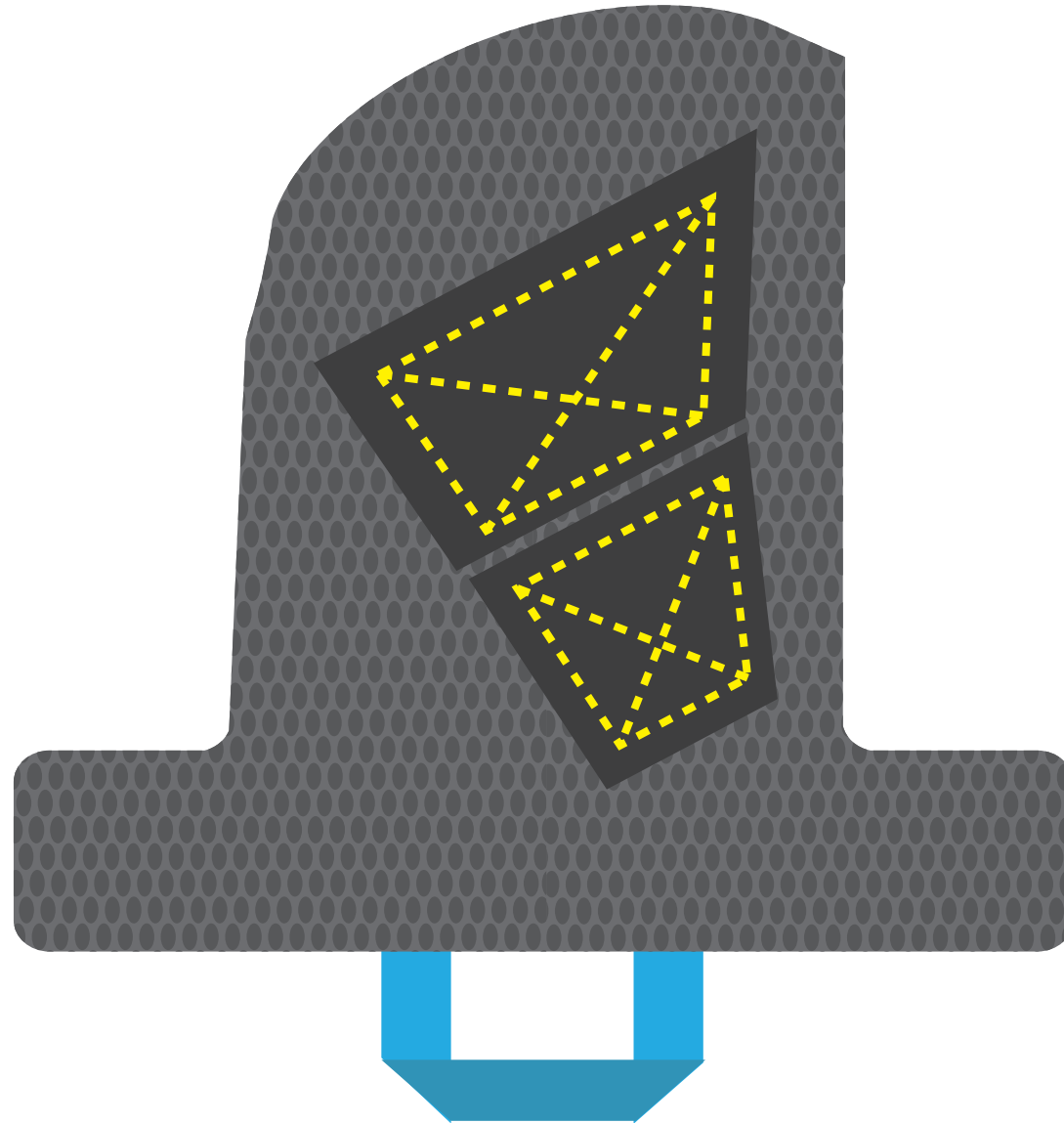

FOLD - - - - -

SEW - - - - -

SEWED - - - - -

CUT - - - - -

SEWING TIGHTENING STRAP 1

STEP 1

sew male velcro B4.3 above C1.2
VELCRO SIDE UP

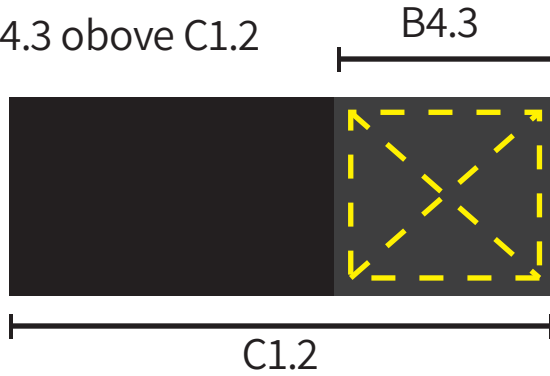

STEP 2

Flip side



STEP 3

Fold C2.1 above C1.2

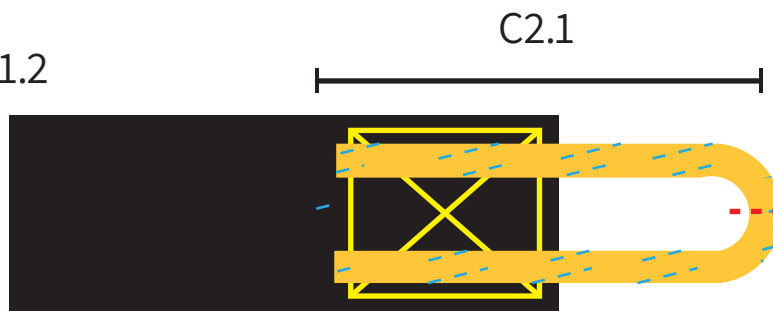

STEP 4

sew female velcro B5.5 above C2.1

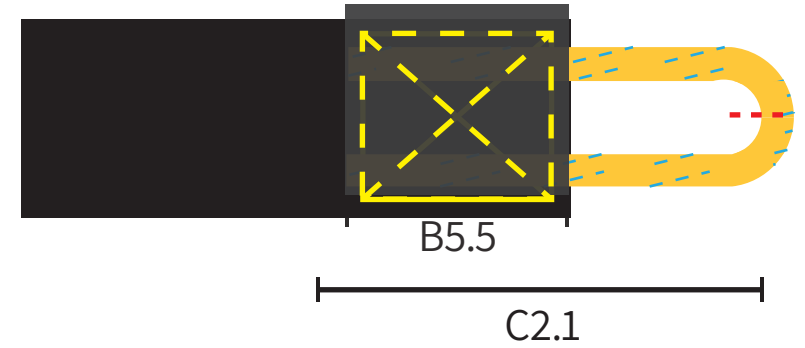

STEP 5

Fold B3.2 above C1.2



FOLD - - - - - SEW - - - - - SEWED - - - - - CUT - - - - -

SEWING TIGHTENING STRAP 1

STEP 6

Flip side

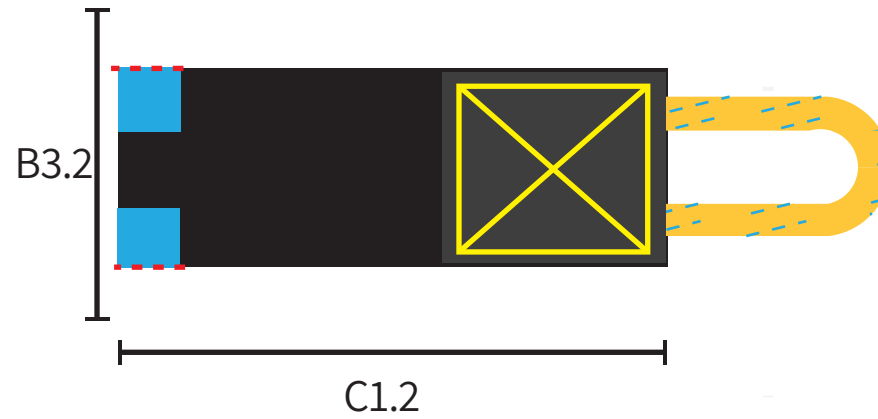

STEP 7

sew B3.2 above C1.2
NOW TIGHTENING
STRAP 1 IS READY

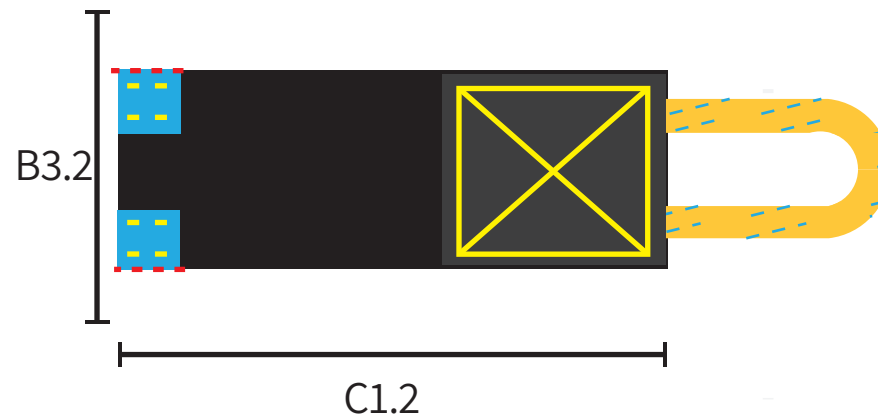

FOLD - - - - - SEW - - - - - SEWED - - - - - CUT - - - - -

SEWING TIGHTENING STRAP 2

STEP 1

Fold C2.2 above C1.3.

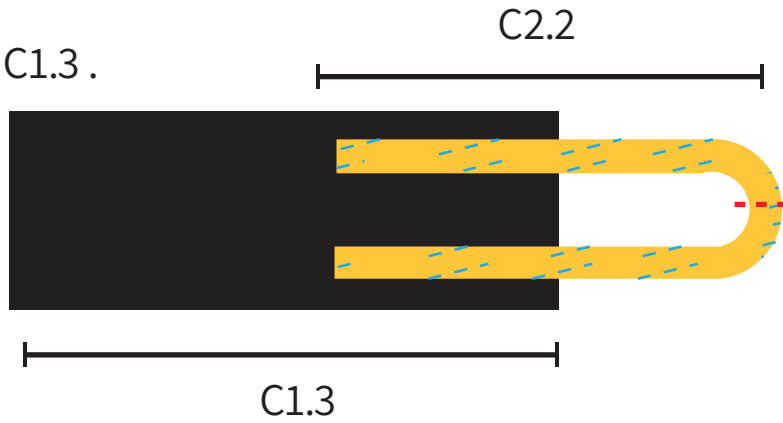

STEP 2

sew male velcro B4.5 above C2.2.
VELCRO SIDE UP.

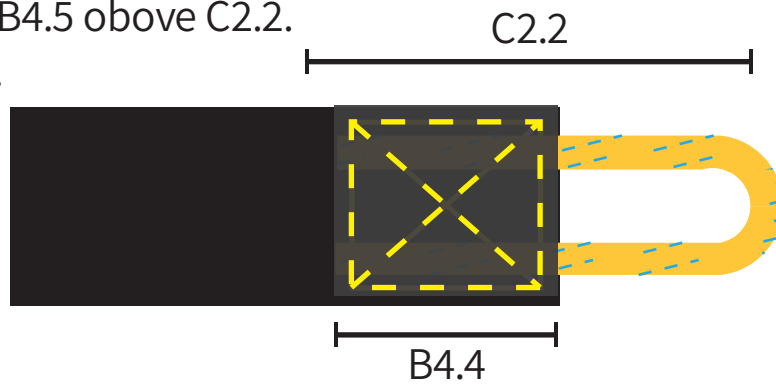

STEP 3

Fold B3.2 above C1.2



STEP 4

Flip side and sew.



NOW TIGHTENING STRAP 2 IS READY.

SEWING A1A2

step 8

Sew the TIGHTENING STRAP 1 and
TIGHTENING STRAP 2 to A1A2.
ABOVE THE MESH SIDE
TIGHTENING STRAPS BLUE STRAP UP.
NOW PART A1A2 IS READY.

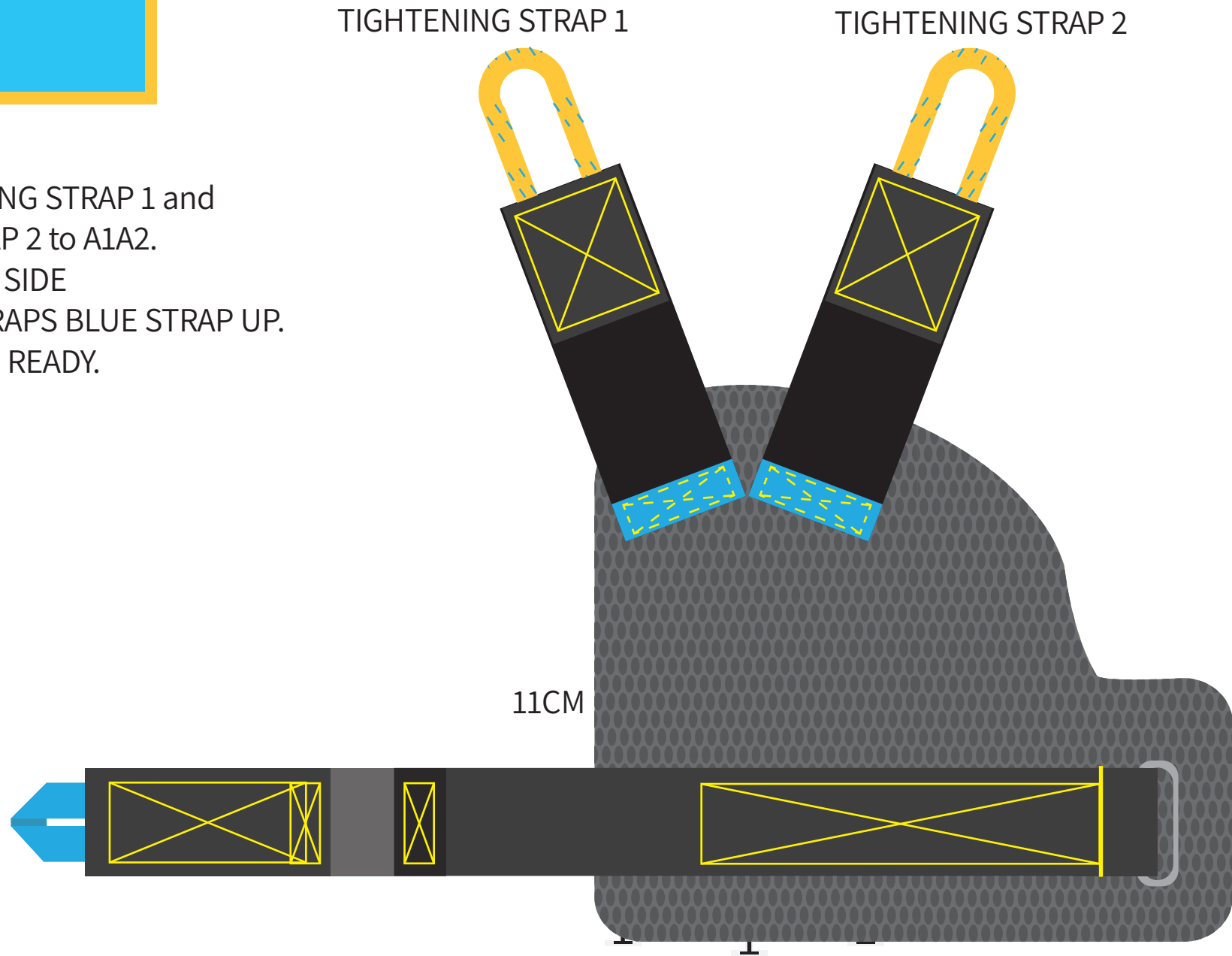

FOLD - - - - - SEW - - - - - SEWED - - - - - CUT - - - - -

SEWING A1A2 TO B1B2

STEP 1

Flip A1A2.
LYCRA FABRIC SIDE UP.

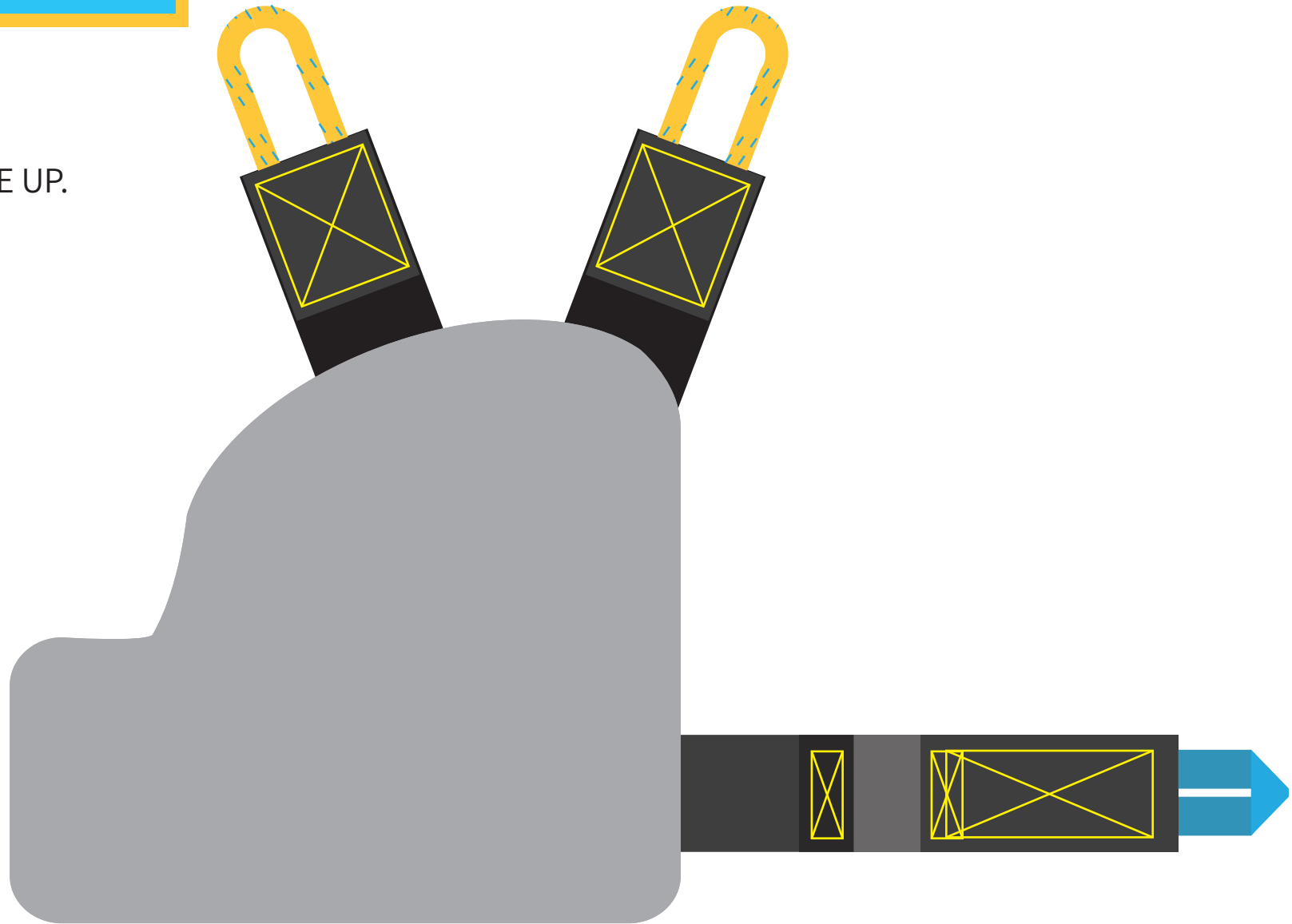

FOLD - - - - -

SEW - - - - -

SEWED - - - - -

CUT - - - - -

SEWING A1A2 TO B1B2

STEP 2

Put A1A2 above B1B2 on the top edge of the round end and sew.

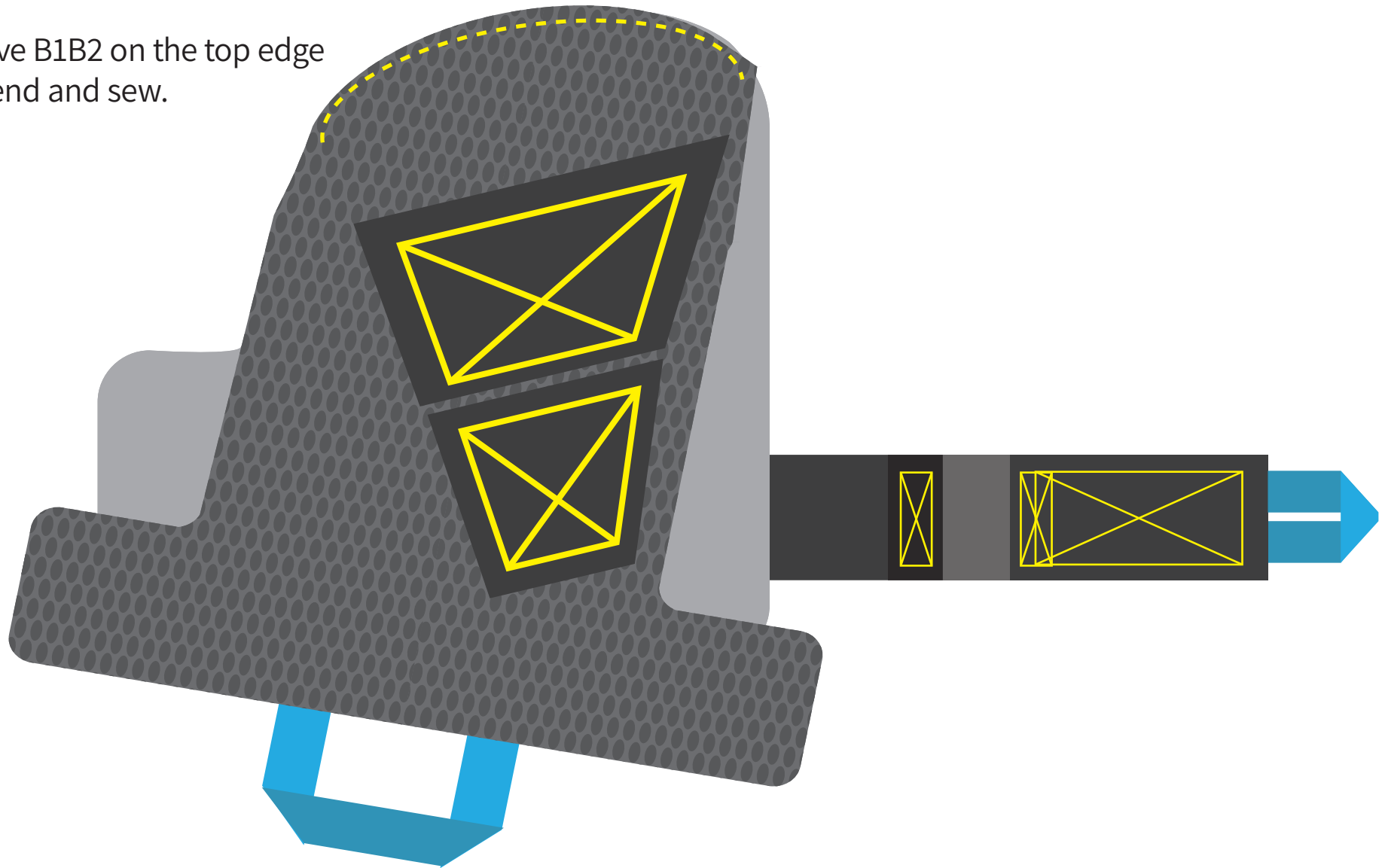

FOLD

SEW

SEWED

CUT