

AC INPUT 220V

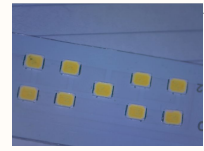

ESLJ RECOVERY DIODE

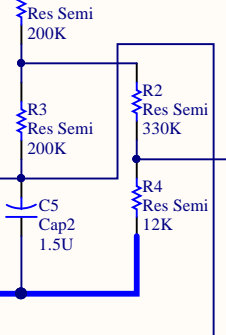
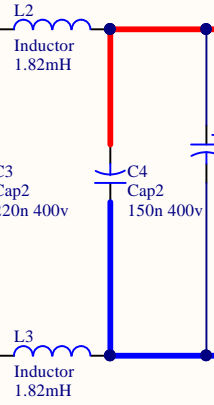
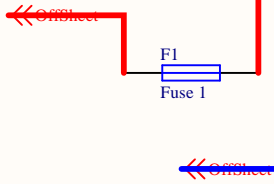
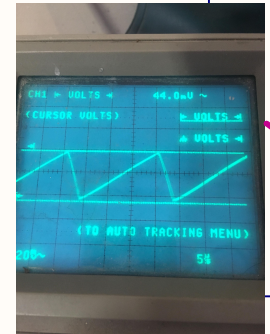
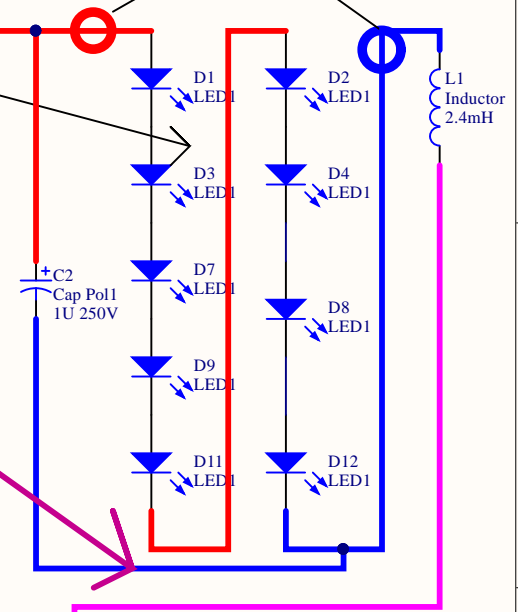

ALL LEDES HB 1W 6,6 FWV 150mA 327 mA Pk.

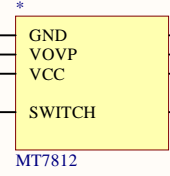

THESE SET IPk //1.22 ohm =400/rcs=327mA

