

Makerspace[®]

@The Tech

COOKBOOK **BETA**
SAMPLER



This Makerspace Cookbook is dedicated to our families, maker friends, our Makerspace guests, the Maker Education Initiative, the Tech Museum of Innovation, educators, and of course, to all future Maker Corps Members and Mentors.

Makerspace[®] @The Tech

COOKBOOK BETA SAMPLER

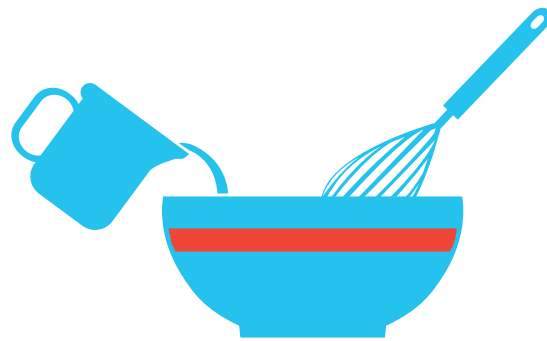

Lindsay took the lead on the Cookbook for the Maker Baker team, mixing all the finest ingredients from the summer's Makerspace into the first draft of the text. Bridget kneaded and rolled the text to get it ready for baking. Kenny masterfully cooked up pictures, videos, and additional resources. Final preparation, baking, sketches, and design garnished with compliments of Maker techno-chef Lindsay!



The Tech
Museum of Innovation

Maker Corps

MAKER EDUCATION INITIATIVE

Table of Contents

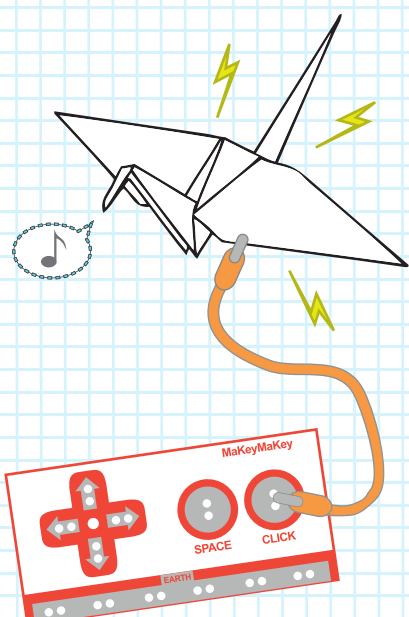
The Team	2
Letter from the Learning Director	3
Makerspace Blueprints	5
Program Breakdown	6
Makerspace @ The Tech Programs	9
<i>Week</i>	
	
1 Squishy Circuits in Space	10
2 MaKey Kitchen	15
3 Patriotic Projectiles	20
4 Switch It Up!	26
5 Paper Engineering	31
6 MaKey CollaboThon	36
7 Aerial Antics	41
8 UFOs (<i>Unique Flying Objects</i>)	42
9 Wild, Wild Tech	50
Our Resources	56
Kenny's Guide to Making Things Make Sound	57
Maker Thanks!	62
Reflections and Connect	63

The Team

Makerspace @ The Tech 2013

Maker Corps

MAKER EDUCATION INITIATIVE

Members

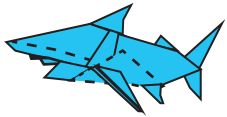

Lindsay Balfour
MaKey



Kenneth Guglielmino
\$\$ ~ NOTORIOUS DIY ~ \$\$



Bridget Rigby
DJ Bridge Bridge



Jessica Henricks
STEAMPunk



The Tech
Museum of Innovation

Letter from the Learning Director

The Tech was thrilled to partner with Maker Education Initiative for the prototype year of their new Maker Corps program. Maker Ed helped recruit over 100 Maker Corps members and put them through an 8-week spring development camp where they tinkered with Maker technologies and built a thriving learning community through Google+.

Then the Maker Corps members went to their respective host sites for the summer. The Tech's Maker Corps members, Kenny Guglielmino and Lindsay Balfour, came full of Maker motivation and ready to make a significant and lasting contribution to The Tech—and to the larger Maker movement.

Kenny came from University of the Arts in Philadelphia, already an Arduino master who loved to make art and technology that lights up and makes cool sounds. Lindsay came from MakerWorks, a Makerspace in Ann Arbor, Michigan. She was getting into electronics herself and came to us with an expertly folded paper engineering background.

Kenny and Lindsay led Makerspace @ The Tech prototyping sessions all summer long, hosting drop-in sessions in The Tech Studio for 2 hours on Tuesdays, Thursdays, and Saturdays. They innovated with new Maker programs and technologies every week. They could be found week after week, tinkering with favorite Maker technologies, from MaKey MaKey that turns bananas into pianos or video game joysticks to Squishy Circuits that turns Play-Doh into colorful circuit-building tools.

Their passions, talents, and positive energy collided in the most innovative ways. They were constantly modeling the Maker mindset of prototyping and iterative design as they prototyped with guests at each of their sessions and made changes for the next sessions based on what they learned. By Saturdays, they really had their programs, materials, set-up, and facilitation down. Their program development process progressed throughout the summer, as they incorporated their innovations and learning into the following weeks' programs.

This Maker Cookbook documents their programs and tells their program development story. In every chapter, you'll find learning goals, materials list, table/facilitator set-up, visual learning tools, invitations to make, facilitation strategies, and so much more for each program. It doesn't just outline how to replicate the program, but captures their prototyping and learning process.

Kenny and Lindsay set out with ambitious goals to develop new programs every week—very rapid program prototyping! Their overall goals were to introduce guests to Maker technologies, giving them the space, tools, and support to make something meaningful, while guests developed their creative confidence and Maker mindsets through ideating, prototyping, problem-solving, learning, and celebrating the failures that lead to innovation. They really wanted guests to see how they could leverage Maker technology as a creative tool for learning and self-expression.

They built Science, Technology, Engineering, Art, and Mathematics (STEAM) into their programs, but rather than going too in-depth into a particular science or technology concept, they focused on the knowledge and techniques that guests needed in order to make. This allowed guests to discover and learn concepts throughout their making process.



Lindsay's gorgeously illustrated whiteboards captured some key science and technology concepts in a very colorful way, making great learning tools and creating a vibrant learning space.

Kenny and Lindsay's programs were a huge success. They developed a Maker following with both guests and volunteers. During their 2-hour sessions, most guests stayed to make for 20 minutes or more, and some stayed making for the whole 2 hours! They had an average of 500 guests each week and, including attendees from The Tech's summer members' party, they served close to 7,000 guests throughout the summer. They generally had 5 facilitators in their space: Kenny and Lindsay, plus 3 Tech staff or volunteers. It was amazing to see so many guests come back week after week to take part in their latest Maker happenings, and to have the consistent support of our dedicated Maker volunteers.

Based on the success of this summer's Makerspace, we'll be doing a lot more Maker-style programs at The Tech! We'll recreate some of Lindsay and Kenny's favorites from the summer, and their programs will help inspire new program innovations. We're already starting to build on some innovations from this summer for our new Star Wars-themed Hands-On Science Workshop, where we can now go even deeper into the science behind these programs than we could for the shorter-term, rapidly prototyped programs.

We're currently developing UFOs into Skywalker Writing, where guests do technological skywriting as their LED-adorned hovercrafts fly around in the wind tubes. Now guests will get to use "The Force" to control the movements of their hovercrafts as they techno-doodle across the sky. The paper circuits from Switch It Up! have turned out to be great solutions for the switch-building design challenge for our Techsabers program, where guests build their own lightsabers and tinker with circuits, switches, and LEDs.

The impact of the summer's Makerspace programs doesn't stop there. We're taking these Makerspace-inspired programs to AT&T Park this year for Bay Area Science Festival. Kenny and Lindsay got to prototype their programs at the summer members' party, and they were even asked by our President to do an encore of Makerspace the week after they finished, both for their Makerspace following and for guests he was taking around the museum to show them what 30,000 square feet of design-based learning will look like!

A huge thanks to Makers Kenny and Lindsay, who were together a perpetual motion program innovation machine (a totally creative, non-linear kind of machine)! They had an unstoppable dynamic between them, and many attributes that made this summer's Makerspace so successful: a sort of interdisciplinary genius, a self-motivated drive to work (and laugh!) really hard, serious motivation to innovate big things together, and to transform lives – both for Makerspace guests and themselves.

We learned so much from working with them, and we laughed a lot too! We got to prototype different levels and styles of support for them to develop as innovators and Makers. They gave us space to try out different approaches and learn from our successes and failures until we figured out the right levels of support. What we've learned through this process has helped build our vision for how we can support and motivate all of our staff at The Tech.

~Bridget Rigby, Maker Corps-dazzled Learning Director

Makerspace Blueprints

At the Tech Museum of Innovation we had 2 spaces to host Makerspace @ The Tech during Summer 2013: The Tech Studio and the Atrium in the Lower Level. Tech Studio was our most common space to work in because of the easy access to tools, the material bins, the projector screen, and standing monitors. It also provided a more controlled environment, compared to the Atrium where the flow of guests could sometimes lead to overwhelming situations. We used the Atrium when we required more space for guests and our program showcase than the Tech Studio could offer. When selecting the space to host Makerspace, carefully consider how many guests are expected to appear that day, along with the number of guests you can serve at one time and the number of facilitators available. When reading the programs in the Maker Cookbook, take note that we were not only developing programs, but also our style for facilitation, and focusing on space design to create an immersive learning environment.

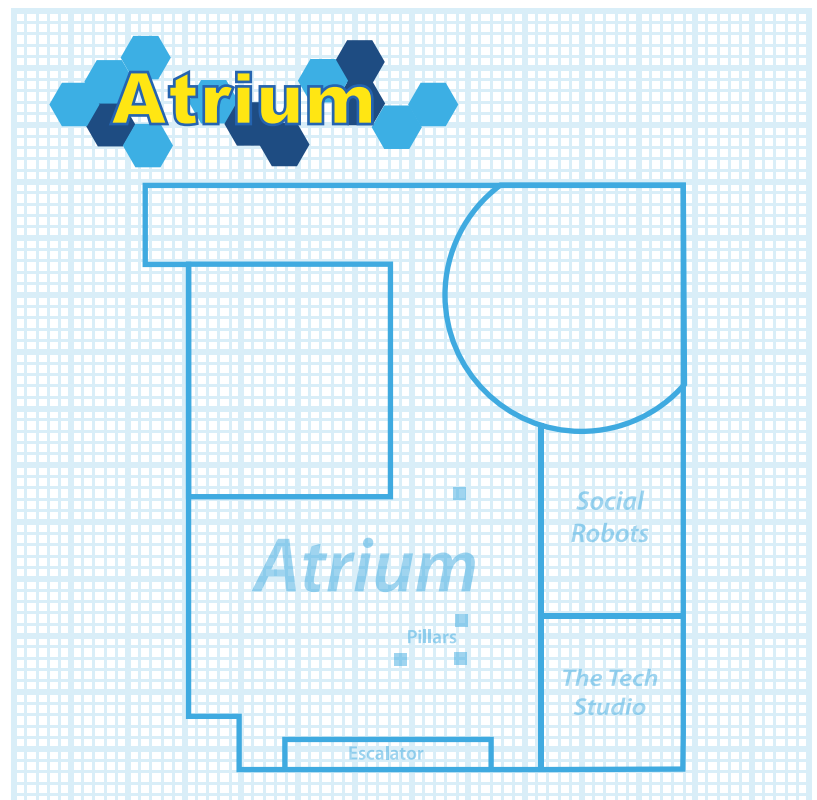
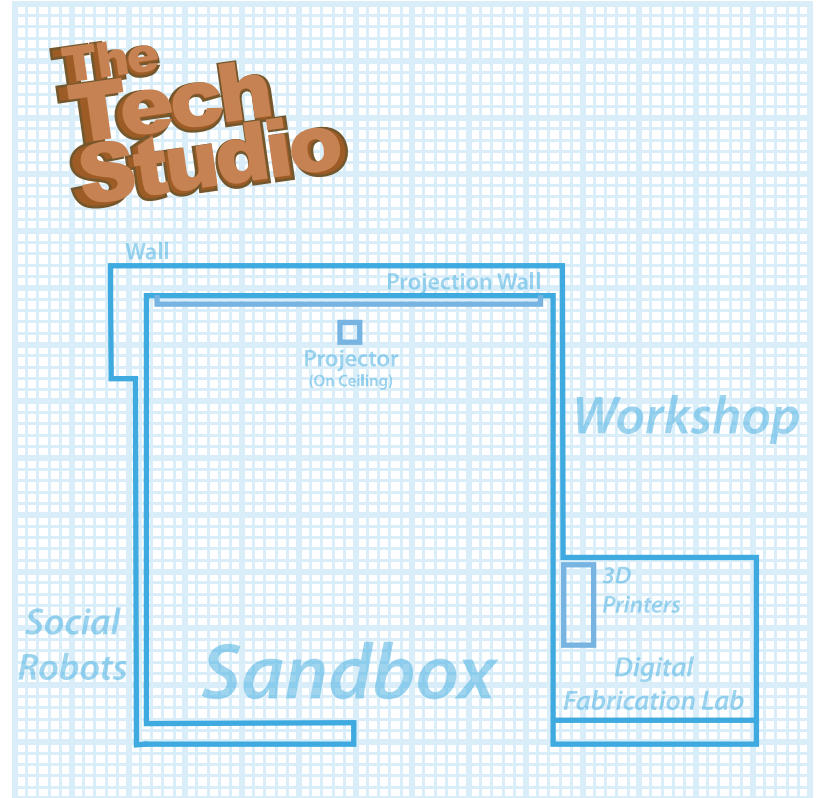

Program Breakdown



Facilitator's Key



Estimated time of average making experience
However, sometimes guests would stay the entire time!



Appropriate Age Range



Ability to work solo or number of people able to work in a group



Level of facilitation required by staff. Levels include light, medium, and heavy facilitation.

* We had at least 5 facilitators for each program: 2 Maker Corps Members, 1 Tech staff, and 2 Tech volunteers.

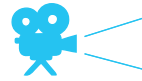

Media Link

To see the blog post, video, and more photos of this particular program.

Squishy Circuits in Space



Facilitator's Key

- 10-25 min
- All Ages
- Solo or 2-3 Guests per group
- Heavy Facilitation

Blog Post, Video, and more Photos!
<http://www.thetech.org/about-us/tech-blog/makerspace-tech-squishy-circuits-space>

Ingredients

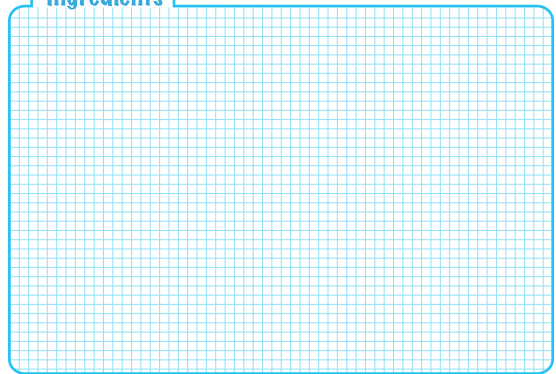

* See Additional Preparation of this Chapter

Goals

1. Guests use Squishy Circuits and Play-Doh as a conduit for developing creativity and grit.
2. Guests learn basic circuitry concepts: how electricity flows, how to make an LED light up, the difference between conductors and insulators—and that Play-Doh is conductive!
3. Guests develop confidence with technology as Play-Doh removes any intimidation.
4. Guests have fun working collaboratively to create a squishy solar system.

Guests Served
We served 15 guests per facilitator at a time for a total of 379 guests for the week.

Week **1** 2 3 4 5 6 7 8 9



Ingredients

These are the materials you'll need to run the program. We found most of our materials in Tech Studio, and always tried to utilize what we had rather than purchasing new materials to stay under budget. Take our Ingredient lists lightly and rotate materials for more innovative making results!



Goals

We generated a list of goals for each program to drive toward learning outcomes, innovation, and guest + staff happiness.

Week 1 Program Week

To keep track of which program week you are on in the Cookbook.



Guests Served

We kept track of how many guests we served at a time for each session and then added the total number of guests for each program.



Set-Up

How we set the stage for Makerspace: the space we chose, table layout, the facilitators' positions, Makerspace prop locations, and path for guests' creative journey through the full making experience. The set-up ranged from a few demo tables and materials tables to workspaces and testing stages.



Space Blueprints

Shows in visual form where the various tables, technologies, whiteboards, and facilitators are positioned. Every program space will be in either the Atrium or Tech Studio.

Set-Up



Space Layout

You'll need at least 2 work tables back-to-back and 1 table to hold all the supplies and serve as a demo table. Encourage guests to work on their creations at the work tables. Spread out black sheets of paper on a large part of the work tables with drawings of silver planets and spaceships, to create a Squishy Universe backdrop for the guests' projects. Add a few of your own examples to help spark ideas for what guests can make. Place mats around the bottom of the work tables to protect carpeted floors from Play-Doh sabotage.

For the first 2 workshops we were right outside The Tech Studio. It was darker there, so the colors of the LEDs were brighter and more dramatic. We had 6 people working on the first day, which was especially good out on the floor since we attracted almost everyone passing by. During days with many summer camps at The Tech, we got overwhelmed fast. The flow of the activity works with the materials table in front and a demo table nearby to introduce the individual materials and show how the technology works. Once guests see the demo they gather the materials and carry them to a separate set of tables where the universe backdrop is laid out.

Invitations to Make

1. Come play with LEDs and light up the universe with your squishy creation!
2. Do you want to learn about circuits as you sculpt with Play-Doh?
3. We're completing circuits using Play-Doh rather than wires!

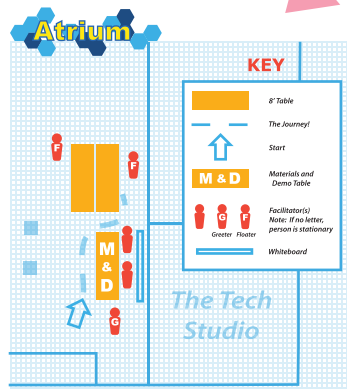

Whiteboard Explanation
How to make a circuit with conductive and insulating doughs.

Present the Making Activity

We're making circuit sculptures out of Play-Doh that light up, twirl around, and make sound to add to our Squishy Universe. Head to the demo table to get your Squishy Circuits kits and learn some circuit basics before you get started.



Whiteboard

We illustrated the program goals, science content, and design challenges as an graphic narrative to make it easier for the Greeter to explain the program to guests.



Invitations to Make

What the Greeter says to lure curious guests walking by.



Present the Making Activity

The Makerspace pitch explaining the entire activity and design challenge.



Troubleshooting

Discoveries we made through interacting with guests during Makerspace sessions. These are helpful and preventive tips to prepare you for possible troubles ahead!



Troubleshooting

Things Guests Need to Know to Start Tinkering

- Conductive vs. Insulating dough: Keep the two doughs separate for these investigations.
- Avoid a short circuit by not touching battery leads to each other.
- Electrons travel through LEDs (light emitting diodes) only in one direction. Long leg of LED is positive. Short leg is negative.
- Electricity takes the path of least resistance.
- If two clumps of conductive dough touch, with 1 LED leg in each clump, electrons will travel directly through the dough so the LED won't light.
- Put insulating dough between two separate clumps of conductive dough to make the electrons travel up the legs to light the LED.

Short Circuits

During the workshops some battery packs were shorted, so we had to improve. Guests may have touched the battery leads together directly or inside the same dough if they didn't separate the positive from the negative. Keep emergency supplies to the side for battery packs especially. We quickly learned to help guests how to avoid a short circuit.

Facilitation

Sharing Technology

Sometimes 30 guests would come at once and we didn't have enough supplies, so we encouraged sharing battery packs and technology. Have families, siblings, and friends' work together. People who work together tend to make larger and more impressive sculptures.

Design Challenges for Making

The Squishy Universe was soon filled with colorful lights and squishy creations, reflecting a spectrum of guests' imaginations. Once the stage is set, guests' natural talents and drive for creative problem solving comes in. Giving guests a design challenge is a great way to start making. Share your design challenge through words and physical actions. Put some good thought into designing a fun and vibrant learning environment with your physical space.

Support Guests While They're Making

Help troubleshoot when LEDs don't light up or when guests have other squishy problems. Recognize something specific that's cool about their squishy innovation. Pose new challenges once they've successfully completed their circuits. When they're finished, place their creations in the Squishy Universe!

Provide Support & Space to Tinker

Let guests come to you with questions while they're making. Look for when they need support and when they need to problem solve on their own. Be ready to answer questions, but don't give away too much. Ask questions that can help them learn through tinkering. Notice when they're getting frustrated and help them work through their challenges. This is when they learn to really engage in a project and stay motivated from start to finish.

Week 1 2 3 4 5 6 7 8 9



Resources

Webpages, books, guides, and other things we used to inspire each Makerspace program.



Resources

The official Squishy Circuits website, featuring recipes, instructions, projects, and more:
<http://coursewebs.stthomas.edu/squishy/SquishyCircuits/>

Make's Squishy Circuits page:
<https://makeitins.com/2019/07/17/squishy-circuits/>

Recipe for Conductive Dough:
<http://coursewebs.stthomas.edu/squishy/SquishyCircuits/conductiveDough.htm>

Recipe for Bonding Dough:
<http://coursewebs.stthomas.edu/squishy/SquishyCircuits/bondingDough.htm>

Reflections

Maker Reflections on Our First Makerspace Program!

We started the program with no expectations and unsure of what was going to happen. We both had experience teaching in our fields, but our goal was to develop a drop-in program on the museum floor. It was definitely a challenge to create a short-term experience for guests who might only be willing to contribute 5 minutes to start.

The Summer's Squishy Innovations

Squishy Circuits was part of last year's Maker Faire @ The Tech Gallery, but this summer we added context for the making activity with the Squishy Universe. We incorporated a space theme that really made a difference in guests' creativity and engagement. Rather than making our own conductive dough, we used colored Play-Doh to brighten the universe.

Fun Things Guests Did & Made

Spontaneous group projects developed as guests shared colors and rolled many little balls together to create long sculptures. Guests were inspired by other people's creations. One guest made a creature to eat a previous guest's planet. Another guest took a previous guest's creation and innovated a new technique by adding LEDs on the inside of the planet to expose a tiny bit of light. One boy even created a giant genetically modified space amoeba that could travel at the speed of light and communicate across the universe with Python code!

Parent & Child Bonding through Making

Some parents jump in and start making themselves, and others want to support their child's learning as they make. Let them have a bonding experience. The goal is to let them figure out how to complete the circuit and create a positively charged family experience while making together.

Week 1 2 3 4 5 6 7 8 9



Makerspace @ The Tech Programs

Squishy Circuits in Space

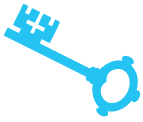

Facilitator's Key

 10-15 min

 All Ages

 Solo or 2-3 guests per group

 Heavy facilitation



Work with others to make the universe a squishier place! Use Play-Doh and LEDs to make our solar system come to life. Learn the basics of circuitry while creating squishy planets, rockets, stars, and more to light the sky.



Blog Post, Video, and more Photos!

<http://www.thetech.org/about-us/tech-blog/makerspace-tech-squishy-circuits-space>

Ingredients

200 LEDs assorted colors of blinking LEDs and large gumdrop LEDs
 20 Squishy Circuits AA battery packs
 100 AA batteries for the packs
 20 Squishy Circuits spinning motors
 20 Squishy Circuits buzzers
 A few plastic knives and forks
 A dough roller
 12 sheets of black 8" x 11" construction paper
 1 silver Sharpie

Conductive and Insulating Dough

- 30 containers of colorful conductive dough (Play-Doh)
Or can use this recipe to make conductive Dough here:
<http://courseweb.stthomas.edu/apthomas/SquishyCircuits/conductiveDough.htm>
- 3 lbs. of insulating dough (only can be homemade)
Insulating Dough **can only be made** with this recipe here:
<http://courseweb.stthomas.edu/apthomas/SquishyCircuits/insulatingDough.htm>

(Optional) To make your own battery packs*

Alligator clips	Electrical tape
12-gauge copper wire	Pliers



* See Additional Preparation of this Chapter



Goals

1. Guests use Squishy Circuits and Play-Doh as a conduit for developing creativity and grit.
2. Guests learn basic circuitry concepts: how electricity flows, how to make an LED light up, the difference between conductors and insulators—and that Play-Doh is conductive!
3. Guests develop confidence with technology as Play-Doh removes any intimidation.
4. Guests have fun working collaboratively to create a squishy solar system.



Guests Served

We served 15 guests at a time for a total of 379 guests for the week.

Set-Up



Space Layout

You will need at least 2 work tables back-to-back and 1 table to hold all the supplies and serve as a demo table. Encourage guests to work on their creations at the work tables. Spread out black sheets of paper on a large part of the work tables with drawings of silver planets and spaceships, to create a Squishy Universe backdrop for the guests' projects. Add a few of your own examples to help spark ideas for what guests can make. Place mats around the bottom of the work tables to protect carpeted floors from Play-Doh sabotage.

For the first 2 workshops we were right outside The Tech Studio. It was darker there, so the colors of the LEDs were brighter and more dramatic. We had 6 people working on the first day, which was especially good out on the floor since we attracted almost everyone passing by. During days with many summer camps at The Tech, we got overwhelmed fast. The flow of the activity works with the materials table in front and a demo table nearby to introduce the individual materials and show how the technology works. Once guests see the demo they gather the materials and carry them to a separate set of tables where the universe backdrop is laid out.



Invitations to Make

1. "Come play with LEDs and light up the universe with your squishy creation!"
2. "Do you want to learn about circuits as you sculpt with Play-Doh?"
3. "We're completing circuits using Play-Doh rather than wires!"

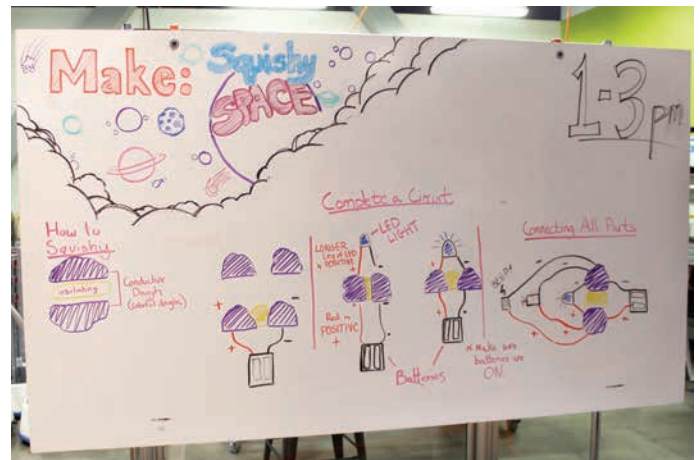
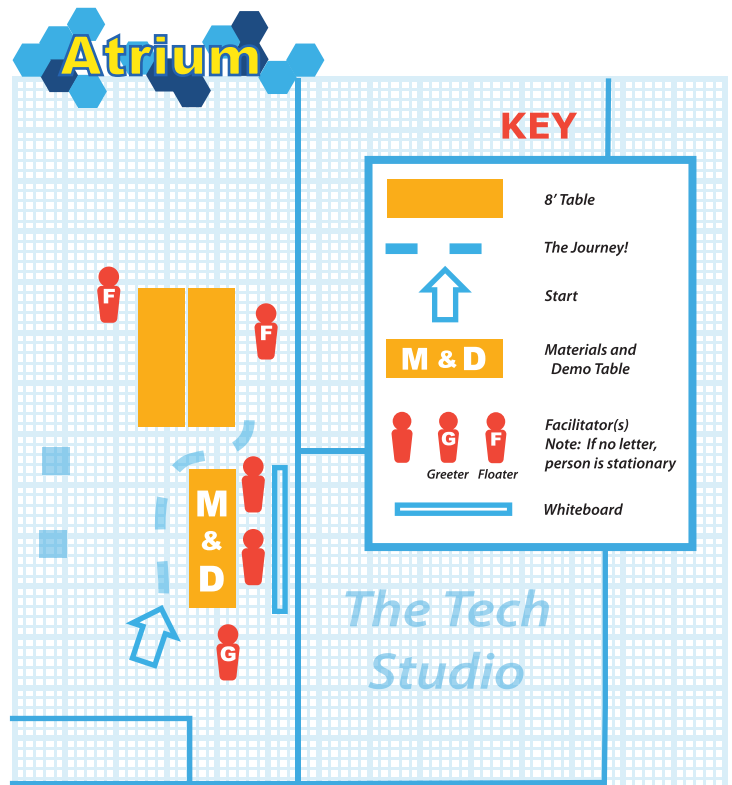

Whiteboard Explanation

How to make a circuit with conductive and insulating doughs.



Present the Making Activity

We're making circuit sculptures out of Play-Doh that light up, twirl around, and make sound to add to our Squishy Universe. Head to the demo table to get your Squishy Circuits kits and learn some circuit basics before you get started.



Troubleshooting

Things Guests Need to Know to Start Tinkering

- Conductive vs. insulating dough. Keep the two doughs separate for these investigations.
- Avoid a short circuit by not touching battery leads to each other.
- Electrons travel through LEDs (light emitting diodes) only in one direction. Long leg of LED is positive. Short leg is negative.
- Electricity takes the path of least resistance.
- If two clumps of conductive dough touch, with 1 LED leg in each clump, electrons will travel directly through the dough so the LED won't light.
- Put insulating dough between two separate clumps of conductive dough to make the electrons travel up the legs to light the LED.

Short Circuits

During the workshops some battery packs were shorted, so we had to improvise. Guests may have touched the battery leads together directly or inside the same dough if they didn't separate the positive from the negative. Keep emergency supplies to the side (extra battery packs especially). We quickly learned to tell guests how to avoid a short circuit.

Facilitation



Sharing Technology

Sometimes 30 guests would come at once and we didn't have enough supplies, so we encouraged sharing battery packs and technology. Have families, siblings, and friends' work together. People who work together tend to make larger and more impressive sculptures.

Design Challenges for Making

The Squishy Universe was soon filled with colorful lights and squishy creations, reflecting a spectrum of guests' imaginations. Once the stage is set, guests' natural talents and drive for creative problem solving comes in. Giving guests a design challenge is a great way to start making. Share your design challenge through words and physical actions. Put some good thought into designing a fun and vibrant learning environment with your physical space.

Support Guests While They're Making

Help troubleshoot when LEDs don't light up or when guests have other squishy problems. Recognize something specific that's cool about their squishy innovation. Pose new challenges once they've successfully completed their circuits. When they're finished, place their creations in the Squishy Universe!

Provide Support & Space to Tinker

Let guests come to you with questions while they're making. Look for when they need support and when they need to problem solve on their own. Be ready to answer questions, but don't give away too much. Ask questions that can help them learn through tinkering. Notice when they're getting frustrated and help them work through their challenges. This is when they learn to really engage in a project and stay motivated from start to finish.

Get Play-Doh into Their Hands

A great way to dig into something as complex as electronics is to have the guests grab the dough and start sculpting. Introduce the electronics as they sculpt. This not only works for kids, but adults too! Many kids will want to dive right in without any background. If they're really young, let them play with the dough while you show them how to make a circuit. Can you roll some balls? Stick the legs of the LED into the dough to see what happens!

Talking Electronics with Guests

Prototype your language for introducing electronics to guests of all ages. Some of the circuit language may be difficult for kids such as the positive and negative leads plus the difference between insulating and conductive dough. Make analogies. Wires are like highways for electrons to travel. Insulating dough is like a wall that stops electrons from flowing through. Show them how circuitry works. Let them see for themselves that the dough becomes a wire and how electrons respond to the dough.

Play-Doh as Motivational Tool

For guests who need motivating, show them what we're making and ask them to help. Let them play with the dough to get comfortable with the materials. One girl didn't want to do the circuits, but we gave her dough and she played with it for a while. Once she did that and was surrounded by people with LEDs, she eventually wanted to do the circuits too. Letting guests play with materials unlocks their creative thinking and removes barriers to making.

Demo to Reality

Have a Demo Table to separate materials from workspace. Take guests through the steps of making 2 conductive Play-Doh clumps and lighting an LED. They still might not fully get it when they're on their own, so support them throughout their making process to help them translate what they learned during the demo into squishy reality.



Additional Preparation

Play-Doh & Power Preparation

We made the insulating dough days before the workshop. As long as you keep the dough refrigerated, it lasts for several days. It may need to be re-kneaded and have some water added to it after each session. We tested and re-tested the battery packs, LEDs, buzzers, and motors. We made a few additional battery packs with alligator clips clipped onto an end of a pack and added stripped 12-gauge copper wire into the mouths of the clips secured by electrical tape. Using just the metal alligator clips didn't go deep enough into the dough to create an electric current. The bare copper wire goes deeper and acts as better leads.

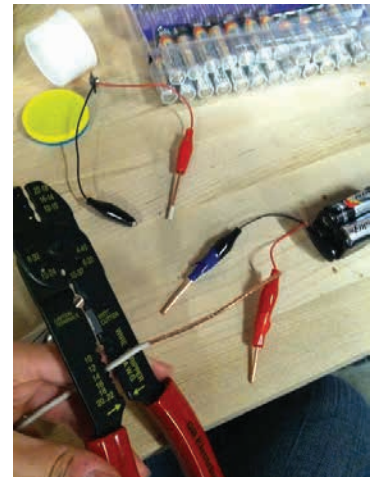

Reflections

Maker Reflections on Our First Makerspace Program!

We started the program with no expectations and unsure of what was going to happen. We both had experience teaching in our fields, but our goal was to develop a drop-in program on the museum floor. It was definitely a challenge to create a short-term experience for guests who might only be willing to contribute 5 minutes to start.

The Summer's Squishy Innovations

Squishy Circuits was part of last year's Maker Faire @ The Tech Gallery, but this summer we added context for the making activity with the Squishy Universe. We incorporated a space theme that really made a difference in guests' creativity and engagement. Rather than making our own conductive dough, we used colored Play-Doh to brighten the universe.

Fun Things Guests Made

Spontaneous group projects developed as guests shared colors and rolled many little balls together to create long sculptures. Guests were inspired by other people's creations. One guest made a creature to eat a previous guest's planet. Another guest took a previous guest's creation and innovated a new technique by adding LEDs on the inside of the planet to expose a tiny bit of light. One boy even created a giant genetically modified space amoeba that could travel at the speed of light and communicate across the universe with Python code!



Parent & Child Bonding through Making

Some parents jump in and start making themselves, and others want to support their child's learning as they make. Let them have a bonding experience. The goal is to let them figure out how to complete the circuit and create a positively charged family experience while making together.



Resources

The official Squishy Circuits website, featuring recipes, instructions, projects, and more:

<http://courseweb.stthomas.edu/apthomas/SquishyCircuits/>

Make's Squishy Circuits page:

<http://makezine.com/2010/07/17/squishy-circuits/>

Recipe for Conductive Dough:

<http://courseweb.stthomas.edu/apthomas/SquishyCircuits/conductiveDough.htm>

Recipe for Insulating Dough:

<http://courseweb.stthomas.edu/apthomas/SquishyCircuits/insulatingDough.htm>

MaKey Kitchen

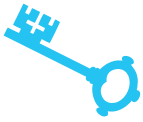

Facilitator's Key

 5 min - MaKey Kitchen demo
15 min - Sketch It! Play It!

 All ages

 Solo or 3-5 guests
per group

 Medium facilitation



Cook up some tunes this week with the Makerspace kitchen crew! Connect to a MaKey MaKey and play with your food as you turn fruits, veggies, drawings, and friends into fun musical instruments. Learn about conductivity while letting out your inner kitchen musician.



Blog Post, Video, and more Photos!

<http://www.thetech.org/about-us/tech-blog/makerspace-tech-makey-kitchen>

Ingredients

Technology

4 MaKey MaKey boards
30 alligator clip wires
4 USB cords for connecting the MaKey MaKey
4 laptops (1 laptop per MaKey MaKey)
10 individual pieces of fruits and vegetables

Sketch It Play It! Materials

300 sheets of blank computer paper	1 electric pencil sharpener
10 thick HB graphite sticks	1 pack of hand wipes
(20) 2H pencils	1 roll of tin foil
20 erasers	1 roll of gaffer's tape
15 clipboards with big metal clips (avoid all-metal clipboards)	1 roll of duct tape *
1 bottle hand sanitizer (for not-as-conductive people to wash hands)	

Add your Own Sound **

2 speakers
4 Processing software programs installed (on each laptop)



* See Additional Preparation of this Chapter

** See Kenny's Guide to Making Things Make Sound in Our Resources at the back of the Cookbook



Goals

1. Guests develop technological confidence/motivation and an innovator's mindset as they connect to a MaKey Makey and tinker with various conductive materials.

2. Guests discover the conductivity of everyday objects like fruit, vegetables, graphite, and people!

3. Guests learn very basic circuitry concepts (conductivity, switches, ground) and get a glimpse into what's going on inside their computer keyboard as they become the switch.

4. Guests design their own musical circuit board while making a work of art.



Guests Served

We served 20 guests at a time for a total of 536 guests for the week.

Set-Up



Space Layout

You will need at least 1 table for a MaKey MaKey demo (2 demo tables is ideal), and another station for drawing made up of 2-3 large tables or 6 hexagonal tables. Put 2 MaKey MaKeys at the drawing station for guests to hook to their drawings, along with examples on the table to show guests how to make their drawings. Keep the clipboards refreshed with paper when not in use and keep the pencils sharpened. For the demo tables, make a conductive hand to introduce the concept of ground. Use gaffer's tape to tape down the grounding clips to the table. Hide electrical cords under a rug to prevent tripping. Place Demo Tables in front to get guests' attention and show them what MaKey MaKey can do, and set up the circuit drawing tables close by so they can head over once they're hooked. Set up a jam station where they'll hook up their drawings when they're finished drawing and ready to start their jam session.



Invitations to Make

1. "Would you like to complete a circuit with surprising materials?"
2. "Would you like to learn about circuitry using your body and other household objects?"
3. "Do you want to draw and then play your own musical instrument?"



Present the Making Activity

Turn everyday objects found in your kitchen into switches! Use your body as a "wire" to complete the circuit by conducting electricity from the ground to the switch.

The
Tech
Studio

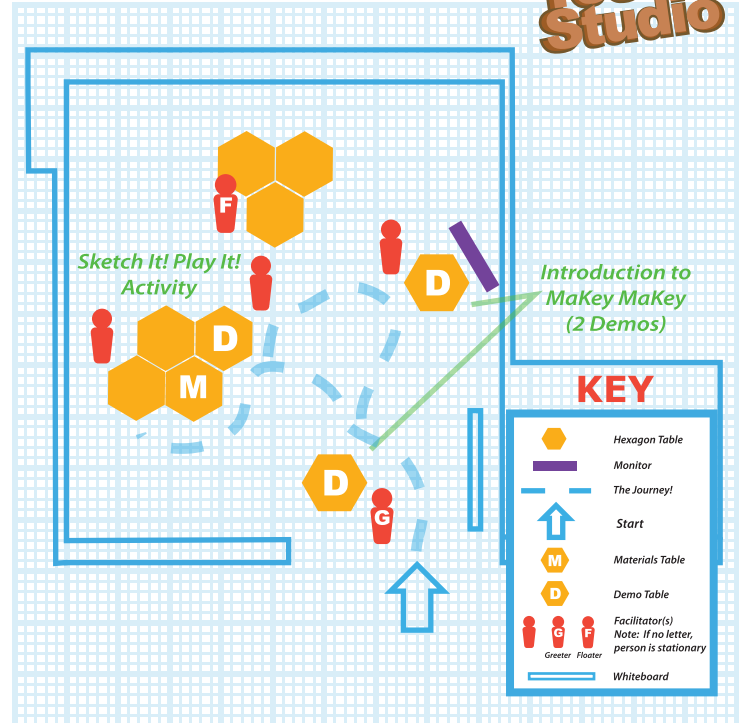

Whiteboard Explanation

Quick introduction of two activities:
Demo of how the MaKey MaKey works
and Sketch It Play It!



Troubleshooting

Non-Conductivity

Some guests might not be as conductive as others. A solution is to wash hands with hand sanitizer. Sometimes the fruit, such as a banana, might have a thick skin and the alligator clips might need to be pushed in deeper to fully complete a circuit. Also always check for a proper connection to the MaKey MaKey.

Keyboard Troubles

Make sure the clipboard is touching the paper, but not the graphite itself. Always check to see if USB port is connected to computer and to the MaKey MaKey itself.

Facilitation



Supporting Guests at the Drawing Table

Some guests will not make dark lines and/or connect all the lines in their drawings. Be proactive and help them along the way rather than at the end when they come up to the MaKey MaKey station and realize their lines won't work. Don't wait at the station, but move around the table and assist with the drawings. If a guest approaches the MaKey MaKey station and it doesn't work, show them why. Sometimes they may not realize the reasoning behind the dark lines until they see it for themselves. Show examples of drawings connected to the alligator clips on the MaKey MaKey in addition to having examples on the table. The lines on the examples should be exaggerated to encourage dark lines in their work. If they're having trouble figuring out what to draw, suggest their name, an animal, or a musical instrument.

Supporting Guests at the Demo Table

Get guests playing with the fruit and interacting with each other while they discover some surprising basics of circuitry. Why are fruits and veggies conductive? Water! People are full of water too. The fruit becomes musical and acts as a keyboard. Briefly explain the ground and the conductive object's roles. Freshly washed hands or fruit work best. Have wipes for people to wash their hands before touching the ground. Some people are more conductive than others!

Some kids might not believe the edible conductive are real. It might be worth taking a bite of an apple just to prove a point (just make sure to wipe the fruit first). Share the science and technology so guests understand that they're connecting as part of a circuit, and as long as they're connected to the ground, when they touch the fruit they become the switch.

Provide Support & Space to Tinker

Let guests come to you with questions while they're making. Look for when they need support and when they need to problem solve on their own. Be ready to answer questions, but don't give away too much. Ask questions that can help them learn through tinkering. Notice when they're getting frustrated and help them work through their challenges. This is when they learn to really engage in a project and stay motivated from start to finish.

Group MaKey MaKey

This program is limited by how many laptops and MaKey MaKey kits you have. When overwhelmed with guests, encourage them to all hold hands and complete a circuit as a group. This makes it easier to deal with huge groups of people at once. Instruct them to wait before touching the ground and holding a conductive object. When the guests see that they can complete a circuit, have 2 people break hands in the middle and do a high-five. Show them that it's possible to show a connection anywhere in the circuit chain. Our record was a 33-person chain!

3 MaKey MaKey Stations

We made many changes to the MaKey Kitchen program. Last week's Squishy Circuits was an open tinkering session with materials and the Squishy Universe on display. For the MaKey MaKey, there were 3 experiences for guests in different places: a straight demo table, another demo table for switching out the fruits and metal objects, and the drawing table. Another difference between this project and Squishy Circuits is that MaKey Kitchen shows multiple objects that are conductive and can complete a circuit.



Additional Preparation

Spoons to Hand-Shaped Grounds

We had two grounds so 2 different circuits could start. We set them up so that when guests touched the person touching one of the grounds, they could touch the conductive objects too. We originally hooked up spoons for the grounds, but we changed them to small sheets of tinfoil with gaffer's tape holding them down in the shape of hand prints so guests knew to put their hand down to connect to the grounds. This provides a visual cue and helps show guests how to connect to the ground without having to explain it so you can avoid awkward "put your hand down "here and there" moments.



Reflections

Learning at the Demo Tables

We placed a demo table in front of the Studio to introduce the science and technology behind the MaKey MaKey. Guests learned quickly, but it was a lot to explain the science for every new guest, especially if a new guest would appear mid-discussion or when we had large summer camp groups of 30 kids. Guests didn't always try all 3 tables, so the interactive demo where guests switched out objects became a straight demo table too. If guests asked how the science worked, we explained the science. If there was a large group of people, we asked them all to hold hands, showed the connection, then explained the science. Learning how to get everyone's attention during moments like these was key to making even a large summer camp group listen and learn a little about the science.

Learning at the Drawing Table

The deeper learning came in when we got people to stay and go through the drawing table experience. Usually the first drawing wouldn't work, even though we'd show an example. We learned to tell guests about the possibility of having trouble and decided to let them discover the trouble and problem solve for themselves. This was a turning point for the Makerspace program because guests began to go back and rework their drawings and iterate. That was when small failures turned into iteration, creative grit, passion, and innovation.

Facilitators Need Support Too

We learned the importance of trading roles and looking to see if certain facilitators were overwhelmed. Kenny sometimes needed to step away to take photographs too, so we covered and looked out for one another. The role of a floater also came into play. A floater comes by and checks on individual guests and facilitators to get a sense of how they are doing and what they think of the program. This has been a great way to get feedback on each program throughout the week rather than waiting until the end of the week. We iterated the programs based on feedback from the facilitators and the guests.

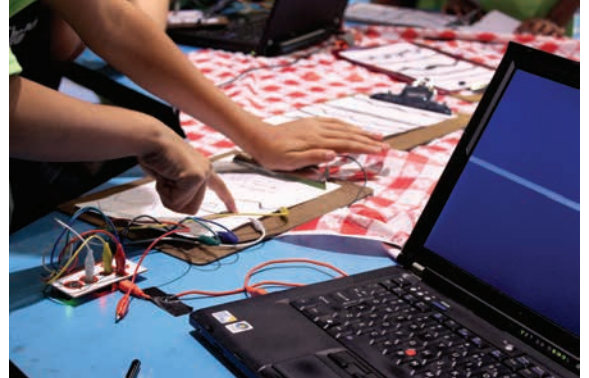

MaKey Variations

We designed our program to show that everyday items like fruits, vegetables, people, and organic things made of water are conductive. The conductive objects can be interchanged, and so can the program connected to the MaKey MaKey. We used music for this workshop, but you can use the MaKey MaKey as a controller for video games like Pac-Man or Dance Dance Revolution. We used Processing, an open-source coding program, to play custom sounds composed by Kenny. You can use SoundPlant, a free program, with the MaKey MaKey.

Picnic Baskets to Chef Hats

We focused on a kitchen theme and we decorated the tables with bright tablecloths, chef hats, bowls of metal utensils, and a picnic basket! The picnic helped set a fun and whimsical tone.



Resources

MaKey MaKey website:
<http://www.makeymakey.com/>

Ideas for MaKey MaKey projects:
<http://www.makeymakey.com/forums/index.php?board=1.0>

Scratch, open source program that can be paired with the MaKey MaKey:
<http://scratch.mit.edu/>

MaKey MaKey Drum Machine Processing code we used:
<https://github.com/kguglielmi/no/TheTech/blob/master/MakeyMaKeyTheTech.zip>

SoundPlant, an open source programming program. Find codes online to develop your own sounds and graphics for the MaKey MaKey:
<http://soundplant.org/>

SparkFun Tutorial:
<https://www.sparkfun.com/tutorials/378>

Patriotic Projectiles

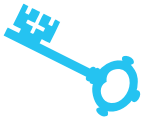

Facilitator's Key



15-20 minutes



All ages



Solo or 2 guests per group



Heavy facilitation



It's the first week of July, so it's time to light the sky! Craft, customize, and launch your own 4th of July paper stomp rockets and watch them "light" the sky like fireworks. Tinker with the laws of physics and colorful designs as you send your rocket flying into the air and create a most patriotic display.

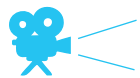

Blog Post, Video, and more Photos!

<http://www.thetech.org/about-us/tech-blog/makerspace-tech-patriotic-projectiles>

Ingredients

2 Rocket Launchers*

To make 1 wind tube:

- (1) 10-foot length of 1/2-inch PVC
 - (1) 1/2" 4-way fitting
 - (1) 12" 90-degree elbow
 - (2) 1/2" end caps
 - (1) 1" coupling
 - (1) 1" by 1/2" bushing
- (all fittings are of the slip variety)

Rocket Body Making

- (15) 11" PVC rollers
(covered with paper and tape)
- 1 Bottle of PVC cement
- (8) 2-liter soda bottle caps
- (20) 2-liter soda bottles
- 20 rolls of masking tape
- 1 hot glue gun and sticks
- 500 sheets of printer paper (at least 11" in height, width does not matter)
- Strong lungs!

Decorations

- 3 rolls of streamers – red, white, and blue
- 8 packs of shiny Mylar - silver, blue, and red
- 3 bags of colored tinsel - red, white, and blue
- 2 packs of star stickers

(Optional) For sound effects when a rocket is launched**

- Pressure sensor
- Gaffer's tape
- Extension cords
- Laptop
- 1 Speakers
- Audio Splitters if 2 Speakers
- 1 Custom sound effect. Check this website for downloads!
- <http://www.soundjay.com/>

* Check Resources at the end of this chapter for the Instructables Rockets to learn how to build the rocket launchers

** See Kenny's Guide to Making Things Make Sound in Our Resources at the back of the Cookbook



Goals

1. Guests develop a prototyping mindset and persistence as they design, test, problem solve, redesign, and retest different variations of their rocket designs.
2. Guests learn basics of paper rocket design: how to roll the body, how to make a nose cone where no air can escape, and how the shape and placement of their fins affect flight.
3. Guests have fun making and launching rockets until they fly the way they want.



Guests Served

We served 35 guests at a time for a total of 937 guests for the week.

Set-Up



Space Layout

Before launching indoors, have Facilities turn off the Atrium sensors. We set up in the Atrium, where the rockets could go up to 50 feet. After our first session, we figured out the best table set-up for this space with a materials station at the start. This helped deal with the Atrium crowds. We placed the materials table facing the escalators, with the rocket-building tables arranged in a circle around one of the pillars. Guests first hit the materials station, where they gathered materials and got a short rocket building intro. Then they brought their materials over to the workspaces where we supported all the rocket-building. We placed the whiteboard with instructions showing how to roll the rocket body, make the fins, etc. facing the workspaces. That way, people could start tinkering for themselves and refer to the board when needed. The rocket launch pad went in the middle of the Atrium, separated from the tables so people could stand in line. We had 2 lines for 2 launchers. Test new bottles and launchers before starting the event. Be a little rough with them to make sure they can handle the force. Set up launcher props, made of a folded stack of printer paper, for the underside of the PVC openings (the knob near the end of the bottle) to help soften the blow per stomp.



Invitations to Make

1. "In the spirit of 4th of July, build a rocket or firework and test it on our launchers to see how high it flies!"
2. "Do you want to make a rocket to light up the sky for 4th of July?"

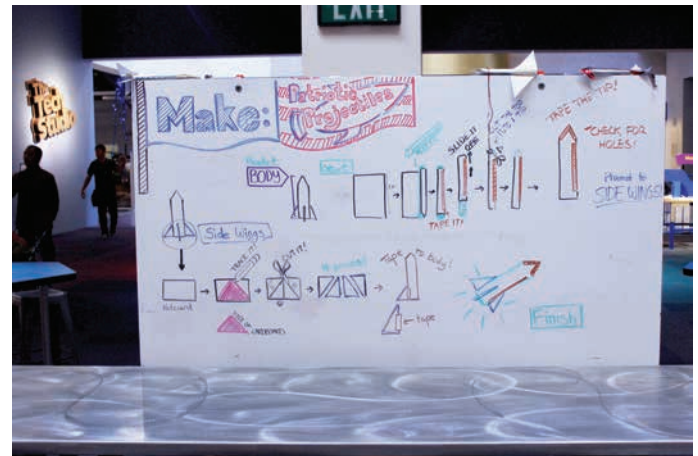
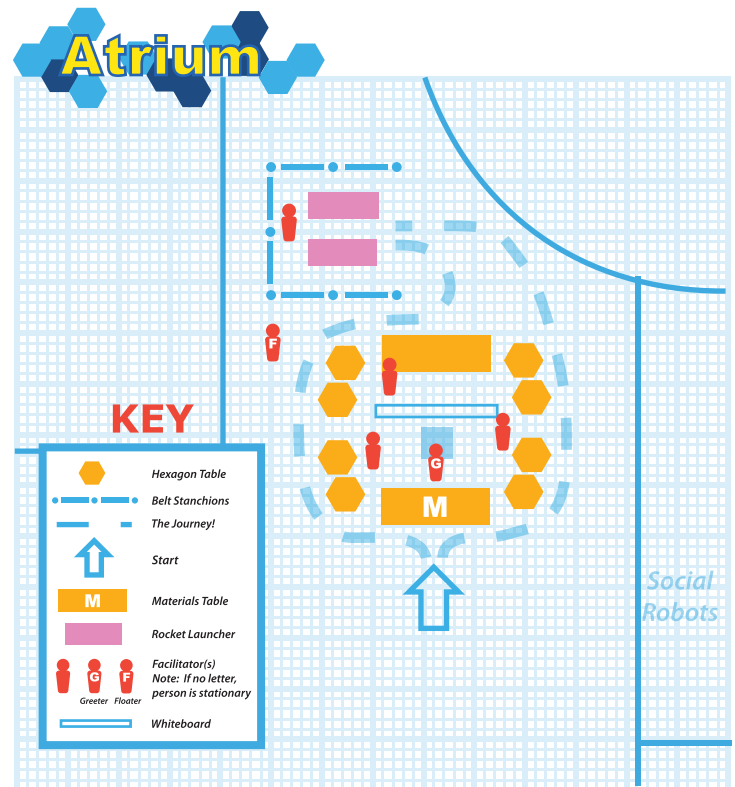

Whiteboard Explanation

Step-by-step visual instructions on making the rocket body and wings.

3. "Add to our fireworks display by making your own colorful rocket!"

Present the Making Activity



We are building rockets in celebration of 4th of July! You get to design, decorate, and put your creation to the test on our rocket launchers to see how high they fly.



Troubleshooting

Launcher Troubleshooting

For future programs, stomp rockets are really fun, but when swamped on a busy day with large numbers of school/camp groups, you need a launcher that can handle the pummeling. Consider using a plastic clear tube instead of PVC and a plastic pump. The only issue is that you can't acquire these objects individually and you might have to purchase a kit. We had more unintentional troubleshooting with the launchers, as they kept breaking. We learned that bottle caps needed to be glued inside the PVC openings. The best way to glue the caps to PVC is to sand the spots first so the glue bonds better. The caps may pop off less frequently this way, but if there's no time, be prepared to make more repairs. We had a lot of trouble with the caps falling out from too many people stomping on the bottles, which weakens the glue hold and pops them out. We used hot glue and epoxy, but they still came out. If the cap pops out, have hot glue ready to glue a new cap back in (not the one that just popped out). If you have a limited number of caps, be sure to re-glue them no more than 2 times. If you keep reusing the same caps, the threads on the inside (the grooves on the inside of the cap that connect it to the bottle top) will flatten and no longer work. It's great to have a spare rocket launcher that isn't used on the floor for emergencies. That way 1 person can go fix the broken launcher while still leaving 2 working launchers. When hot gluing, give the cap and PVC opening at least 15 minutes to cool off. When launching, if parts of the PVC launcher pops off (such as the sides keeping the launcher standing up), apply PVC glue to the joints and let it dry according to the instructions on the bottle. This must be done before the event to let the glue dry fully. Apply duct tape over the joint for additional security.

Facilitation



Rocket-Building 101

When showing how to make the rocket, work with multiple guests at once rather than 1 at a time. It gets very busy in the Atrium, and it helps to demonstrate for groups. Parents usually help out with the process. Encourage kids to work on a rocket with you if there's time. If it's too busy, have everyone make their own rocket or work together on rockets following your lead as you build your own. Most kids get the concept of rolling paper tubes, but be sure to show them the proper way to do it. Don't let them hand roll rolls, because they won't fit on the PVC launcher! Make sure they know to take the PVC pipe out of the rocket body after they tape it together, so they don't go to the launcher with the pipe still inside. We have one way of making the rocket tip that's simple and very efficient. If the guests want to try another way of making the cone, feel free to let them. However, because of limited time, quickly show them how to make the cone and the side fins of the rocket and then let them explore what kind of cone to use, how many fins to attach, how they arrange the side fins, etc. Let them know about the decorations for when they finish building the rocket structure. Tell them that decorations are fun, but not to overdo it because too many may affect the rocket's stability during flight. Have them blow into their rocket to make sure there's no air

coming out through any small holes. Have them do this blow test before they line up for the rocket launchers.

Rocket Iteration!

After they launch their first time, challenge guests to come up with new ideas for building their rockets. What happens with 3 fins versus 2? Or 6? What happens with a big cone at the top versus a small one? What happens with a Mylar body rather than a sheet of paper? What happens with streamers flying behind it? What happens if it's too heavy? Pose these questions, or maybe a guest will ask, "What happens if I do this?" Answer, "find out!" This leads them to finding out and innovation through iterative design. Let them fail and help them adjust at the end. They begin to understand how the rocket works the third time rather than the first. There's nothing wrong with letting them figure it out and see for themselves when it doesn't launch or fly. This program has shown us a major goal of our Makerspace program: creating the space for failure and giving guests the opportunity to demystify it!

Non-Stompers

For a non-stomping option, use a PVC pipe and place a rocket on the end like a blowdart!

Rocket Launching

Place stanchions around the launchers to prevent people from walking up to them from any direction. Have a few rockets at the launcher to show off in the beginning—it's really easy to draw people in once people see the rockets fly! Have a few complete rockets in case guests'

rockets don't work and they get upset. You'll need lots of bottles. The 15 we started with were enough for 2 days, but not enough for 3 days. After each launch, ask the next guest in line to wait a moment and cup your hands on the PVC opening where the rocket is inserted and blow to re-inflate the bottle. Don't blow directly on the PVC pipe. Once the bottle is inflated, ask the next guest to come up and place their rocket on the launcher. Give them 10 - 15 seconds to try. If they can't get it on by themselves, place the rocket on the launcher for them. Ask them to step to the side and have them wait before launch. If possible, have both guests launch together. When guests are setting up to launch, ask them to stomp on the cylinder portion of the bottle (where the bottle label is adhered) and not the bottle's neck or bottom part where the plastic is harder. Ask them use 1 foot rather than stomping down full force with 2. Otherwise, they could blow out the bottle, break the launcher, or hurt themselves.

3, 2, 1...BLAST OFF!

When launching, shout "3, 2, 1..BLAST OFF!" to keep people organized and engaged, as they're getting ready to launch. Everyone chimes in at the same time to prepare for blast off. The person working at the launch-pad leads this countdown to make a big spectacle of every launch. On "BLAST OFF", guests stomp down and launch their rockets into the air.

Iteration through Decoration

Some of the troubleshooting for this program is intentional. We provided many decorating options: tinsel, streamers, shiny Mylar, and much more. It's possible for all of these elements

to provide drag or make the rockets too heavy to launch. When their rockets don't go very high, point out a few elements that may have led to their rocket not launching far. There might be holes in their rocket tip, so make sure to check for holes before launch, when placing the rocket on the launcher. It's easy to fix. If you see that there are a lot of streamers on the bottom, launch it so the guest can see why that may or may not work. During our event, most guests fixed a first-time launch problem and came back to launch a second time.

Placement Importance of Materials Tables and Launch Zones

The materials table was a great innovation so guests can get what they need, but not crowd. Tell guests to grab tape, paper, cardboard rocket tip, fin cutouts, and a pencil. They can come back for their decorations after they finish making their rockets. If they want to take the decorations right away, let them! They might help to inspire their rocket designs. Have the guests gather their supplies and direct them to the rocket-building tables. Tell them someone will be walking around for rocket-building support as they start to build their rockets.

Fireworks Sounds

Kenny added fireworks sound effects to our stomp rocket launchers. He placed a force sensitive resistor beneath the stomp rocket pads, so that every time guests stomped and launched their rockets, fireworks sounds were triggered. An innovative way to "Technify" the stomp rockets. For more on rigging sound, see Kenny's reference

document called, “Kenny’s Guide to Making Things Make Sound” in OUR RESOURCES at the back of the Cookbook. You’ll need an audio splitter for multiple speakers.

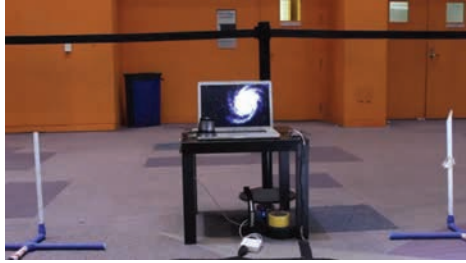

Reflections

Makerspace Takes Center Stage

Being in the atrium gave our program a lot of attention and support. Other guests could watch the rockets launch and see the guests building rockets from any level of the museum. It was fun to see siblings launch rockets, and have families all launch the same rocket together. There was lots of cheering and support from the rocket-launching crowds. The guests up next to launch were center stage, which made for a great build up to their launch. This program was reminiscent of The Tech’s Ready, Set, Fly! program, where guests could see the launches and cheer on the other guests as they launched. This created a sense of community and everyone was really into other guests’ rockets. Some guests would even catch the rockets in midair!

Physical Learning Tools & Space Design

This program required a lot of facilitation, and walking through the steps with guests. It’s not something guests can just figure out by themselves. However, this program showed us what a great bonding activity this can be for parents and their children. We saw that parents were becoming more

involved with the making and testing of the rockets—some even made their own! The whiteboard became a very important learning tool for this program, as it was possible to figure out the rocket designs from the drawings, and refer back to them if a step was forgotten. The board was color coded so people could see how different rocket parts (body, wings, fins, tape, etc.) fit together, step-by-step. The whiteboard helped structure the experience for people, and added a colorful design element to the physical space. Arranging the tables was also very important in leading this program. Carefully designing the layout has become a key component in the smoothness of any Makerspace program.

Tech Programs Mash-Up

Some guests took their rockets next door to the Hands-On Science Workshop and used them to make cool patriotic automata toppers. Consider having a make-and-take where budget allows. It’s great when kids can decorate and build, and take their creations home.

We <3 Rockets!

This was probably our most successful program so far — lots of interaction, iteration, and learning. Rockets are just so cool, and there was a great show element to this program that really had a positive effect on guests working their way through the iterative design process.

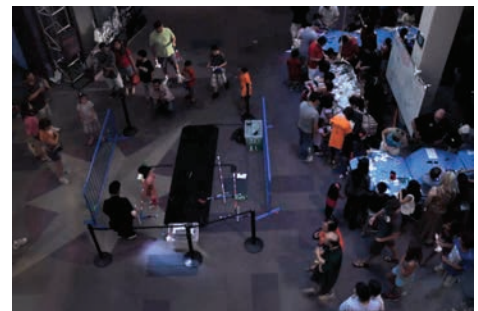



Resources

Instructables Rockets:

<http://www.instructables.com/id/Paper-Stomp-Rockets-Easy-and-Fun/>

A simple rocket launcher with a plastic tube instead of PVC:

(Only problems: short range and you have to aim so there's a risk of aiming at other people.)

<http://www.instructables.com/id/parts-21/step2/take-the-pen-apart/>

Example of a Kit without the DIY:

http://www.fatbraintoys.com/toy_companies/d_l_company/ultra_stomp_rocket.cfm?source=google_pla&kwid=ND068&gclid=CPTDgu-5srgCFQnhQgoduXwAFA

"Kenny's Guide to Making Things Make Sound."

See OUR RESOURCES at the back of this Educator's Guide.

Switch It Up!

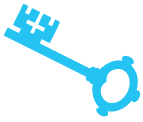

Facilitator's Key



20-25 minutes



Ages 10 and up



Solo or 2 guests per group



Heavy facilitation

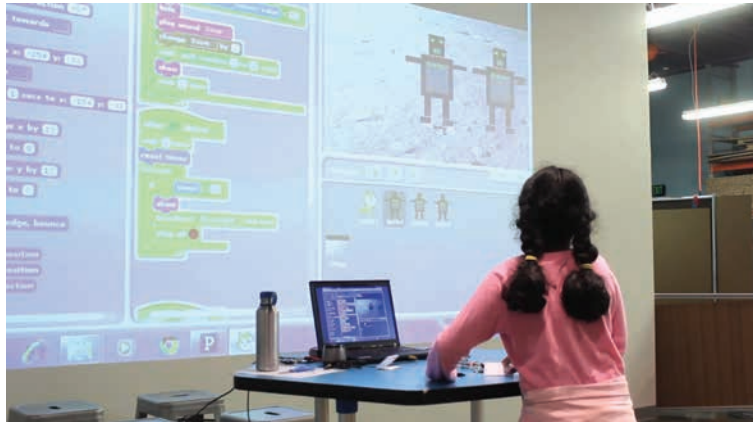

Connect paper with your computer this week at Makerspace. Learn how to make a switch with paper and copper tape. Plug your switch into a PicoBoard and use the programming language Scratch to play paper-powered games projected onto the wall of The Tech Studio.



Blog Post, Video, and more Photos!

<http://www.thetech.org/about-us/tech-blog/makerspace-tech-switch-it>

Ingredients

Technology

2 PicoBoard kits
2 Laptops or 1 Laptop and Rolling TV screen
2 Scratch programs playing 2 Whack-a-Robot games, installed*
20 alligator clip wires

Switch Materials

300 sheets of construction paper
300 sheets of printer paper
20 sheets of instructions for various origami pieces (fortune tellers, cranes, boat, etc.)
4 rolls of conductive copper tape 1/4" 36-yard roll
20 rolls of masking tape
10 sets of 12 colored pencils
10 sets of 12 washable markers

(Optional) For Extra Loud Sound

Speakers



Goals

1. Guests connect to technology and develop an innovator's mindset through problem solving with paper circuits and finding creative solutions to our switch-less video game problem.
2. Guests learn basics of circuitry and how a switch really works through building their own.
3. Guests begin playing with paper and see that it can be used as a technological tool.



Guests Served

We served 20 guests at a time for a total of 399 guests for the week.

Set-Up



Space Layout

Set up a Demo Table at the very front of the Tech Studio to draw people and show them what we do. The Materials Table comes next and then open tables surrounding it for people to work on their paper switches. The last table in the back of the Studio is connected to the projector and is where guests connect their projects to the PicoBoard and play Whack-A-Robot.

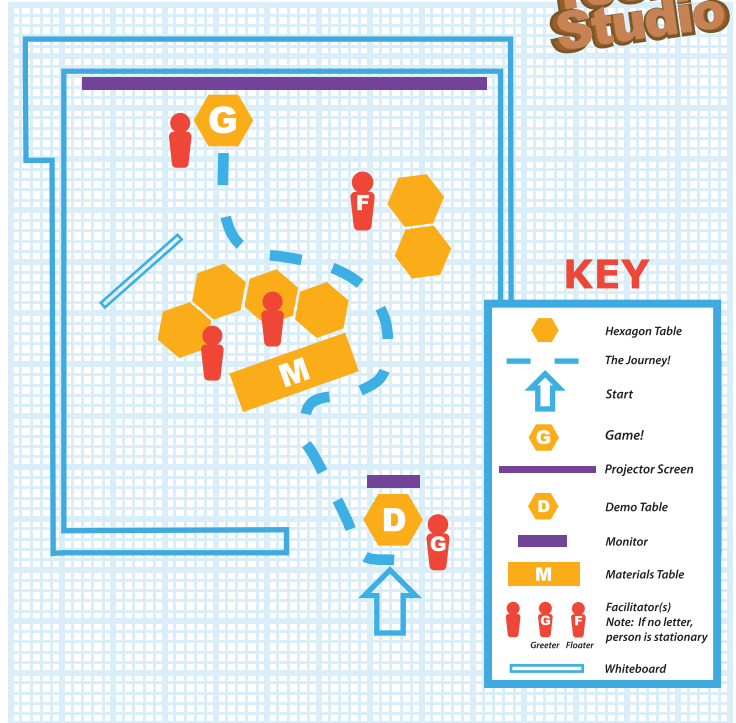

Invitations to Make

1. "We have a really fun game called Whack-a-Robot, but we forgot our controllers at home. Can you make a switch to help us play the game?"
2. "Come build your own paper switches to power our Whack-a-Robot game!"



Present the Making Activity

In our game we are creating an on-off switch that whacks the robots on the game we programmed. The best part is that you can turn anything into a switch! Paper airplanes, fortunetellers, paper cranes, paper puppets, and so much more!

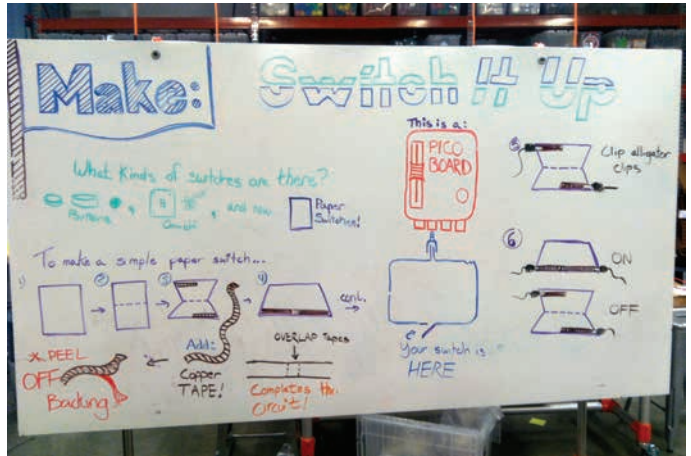

Whiteboard Explanation

Comparing different kinds of switches and how to make a simple on-off paper switch with the Picoboard.



Troubleshooting

Technique for Struggling Switch-Makers

We developed a technique for making longer copper tape leads when a guest is struggling. Briefly share why the proposed solution works: 1 side of the copper tape is conductive and the other side is adhesive and sticky. The circuit won't work if the tapes overlap with the copper face up and the adhesive on top of the copper face. It will only work if the copper faces touch each other. You can either solder (which we won't do on the floor) or wrap one of the pieces of tape all the way around the other piece so the faces eventually touch. With the adhesive side up, place a piece of paper over it or rub fingers on the adhesive until it's not tacky.

Facilitation



Origami 101

Some guests may not know what to make, so encourage them to take the origami instructions provided and make a switch based on those origami shapes. Have a pop-up card example, etc. If people ask how to make a certain paper origami shape, like a paper airplane, lead them through the process. There will be lots of questions, but keep everyone on the same step and catch people up if they fall behind. If guests step in midway through, let them know you'll get them involved in the next round. Guests may not want to wait, but let them know you want to finish the group you're with and will begin another group soon. The more origami shapes you know how to make, the better—like paper airplanes, fortune tellers, paper cranes, etc. Having 1 person at the paper-folding station to answer all guests' questions is tough, but it can be done if you can figure out how to delegate questions and prioritize which guests to help first.

Creative Switch Examples

The concept of switches was challenging to communicate to guests, which is why we made lots of examples showing a variety of ways to make a paper circuit. There was a bird puppet, a simple switch, a fortuneteller,

an animal “pop-up,” and more. The examples really helped motivate guests to start the project. Having instructions for various origami projects for guests to follow meant that the facilitator leading the table wasn't overwhelmed with teaching.

Technical Switch Examples

We had examples with different methods of connecting circuits to help guests figure out how to place their copper tape leads. We also had a set of PicoBoard alligator clips to attach to their pieces so they could visualize how to connect the copper tape and how their switches would turn on and off. (Sometimes the switch part may not connect well because the bulky alligator clips get in the way, so they need to make tabs outside of the switch so the button can open and close better.

Help Guests Electrify Their Switches

We had large groups start drawing and creating paper shapes, and then after they finished, we had them start a line for us to help electrify their paper circuits. This can work with a single struggling guest too. Have the guest create a switch first and then help electrify the switch. This is a tricky project, but with some help even young kids can make a switch. It's a little tricky to peel off the adhesive from the copper tape, so be ready to help with this! If crowded, ask parents if they can help or they can get help from the facilitator at the Materials Table.

Prepare Copper Tape

Prepare by providing a lot of paper examples, origami pieces, cards, and other innovative projects. Make sure to have a few examples that are simple especially so they can be used as a teaching tool to explain the science of circuitry. This particular Makerspace program is difficult to learn right off the bat so be patient when teaching individual guests. Cut small strips of copper tape and hand out when guests are finished making and decorating their switch.

Reflections

Switch-Making Motivation in Multiple Dimensions

Getting people to do this Makerspace was more challenging, but having the demo table at the front made a big difference. The hardest part was getting people to come up with inspiration to make something fun and creative. It can be challenging to get guests inspired if they don't really want to do it. With young kids, let them draw and color just so they can get in the mode of creating. Most kids started making 3D projects rather than 2D—but some people don't feel as comfortable so making something 2D could be a good way for them to start.

Maker Iterations of Programs

We struggled with this program and didn't quite get it until Saturday, our final day of the program. Thursday's session was good, but it still needed work when there was only 1 of us at the paper-folding station. The program works better with 2. This program was more free form and guests needed more of a push from us for inspiration. Instead of having a stable project (like the projectiles type of make-and-take)

the guests had to get more creative to develop their paper shapes.

Very Rapid Program Prototyping

We created this program through an even more rapid prototyping process than usual. The Thursday before, we realized the paper-engineering program we were developing wasn't going to be ready for the next week. We were close, but we didn't have a solution for the design challenge scenario that would give the program some much-needed context. We'd hooked up paper circuits to PicoBoards at the start of the summer when SparkFun came through on their national tour and led us through a scaffolding of electronics projects, so we really wanted to do something with the PicoBoards from that. We created Switch it Up! very quickly and figured out major problems during the actual program week. This particular program shows we can come up with something on a last-minute basis if we really need to, but we really struggled because of the lack of time put into the program development.

Cool Switches and Further Switch Innovation

A ball machine (inspired by The Tech's ball machine outside), a standing cobra, a hand puppet, paper airplanes, a blue alligator with braces, and so many other creative projects were born from this program, but we only scratched the surface. This program can become something more with further prototyping and development, such as figuring out some prompts to inspire guests to think outside the traditional paper switch box. We're very happy that program development continues as our paper switches inspired a potential switch design for the Techsabers program for Jedi Tech, the Star Wars-themed Hands-On Science Workshop.

The Ultimate Maker Collaboration

This program was a true marriage of Kenny and Lindsay's unique strengths—the ultimate collaboration of Kenny's electronic mindset and programming talents and Lindsay's creative paper-engineering skills! This program required a lot of focus from the guests so it was more challenging to create the usual Makerspace atmosphere, but the guests that stayed were committed to the project and pushed it to new bounds. Lindsay focused her paper-engineering talents on helping guests figure out how to make their switches and how to electrify them. There were a lot of questions and it was challenging to motivate guests to make a unique paper switch without a good prompt. The game was a reason for them to make a switch, but it wasn't enough of a reason to make a creative-looking switch unless they were really driven.



Resources

Whack-a-Robot Scratch code:
<https://github.com/kguglielmi/NoTheTech/blob/master/WhackARobot.sb>

Getting started with PicoBoard, SparkFun:
<https://learn.sparkfun.com/curriculum/7>

Getting started with PicoBoard:
http://www.picocricket.com/pdfs/Getting_Started_With_PicoBoards.pdf

Scratch Program:
<http://scratch.mit.edu/>

PicoBoard Website:
<http://www.picocricket.com/picoboard.html>

Paper Engineering

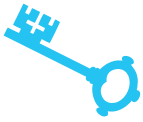

Facilitator's Key

 30 minutes (For a good structure)

 All ages

 Unlimited number of guests

 Light facilitation



How do you transform a piece of paper into a stable structure? Fold, roll, and design with paper shapes to withstand falling objects! Learn about paper engineering and how you can work with paper as a building tool for your imagining.

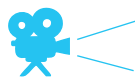

Blog Post, Video, and more Photos!

<http://www.thetech.org/about-us/tech-blog/makerspace-tech-paper-engineering>

Ingredients

Paper Structure Materials

1500 sheets of paper (this includes paper for the weights)
 20 rolls of masking tape
 Lots of patience to make a structure
 12 boxes of 12 ice cream cones/cake cones
 Plastic/paper cups just a little larger than the ice cream cones
 A 12" x 12" arena or frame as the cone crushing arena
 35 ¼" dowels for rolling paper

3 various paper weights

Stacks of scrap paper with butcher paper wrapped around to secure the weight.

- 150 pages
- 275 pages
- 500 pages

(Optional) For sound effects when a cone is crushed*

Pressure sensor	1 custom sound effect. Check these websites for downloads!
Gaffer's tape	• http://www.soundjay.com/
Extension cords	• http://www.grsites.com/archive/sounds/
Laptop	• http://www.sounddogs.com/category-search.asp?Type=1

* See [Kenny's Guide to Making Things Make Sound](#) in [Our Resources](#) at the back of the Cookbook

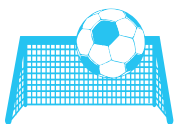

Goals

1. Guests become motivated and confident paper engineers as they take on this rescue mission: build a structure to protect a distressed ice cream cone!

2. Guests develop an innovator's mindset through lots of trial and error thinking as they design their cone-protecting solutions.

3. Guests learn about structural engineering, which shapes are the most effective, and how strong paper can really be.



Guests Served

We served 40 guests at a time for a total of 357 guests for the week.

Set-Up



Space Layout

Set up the tables to accommodate as many people as possible and no table needs to be designated for materials. Spread materials on the tables and provide plenty of chairs. Create a separate station for the drop zone with enough space to have many guests crowd around the drop arena to watch paperweights being dropped on guests' paper structures. Mark a line around the drop arena for guests to stand safely around while this happens.



Invitations to Make

1. "Protect the ice cream cone from doom with rolled paper!"
2. "Learn how to build strong structures to withstand weights using only paper!"



Present the Making Activity

Create a structure made entirely out of paper. We'll put it to the test when we drop weights, also made entirely out of paper, right on top of it to see if it can protect the ice cream cone. We'll show you how to roll paper tubes, transform them into triangles, and tape them together, but you're free to make other shapes from the tubes too!

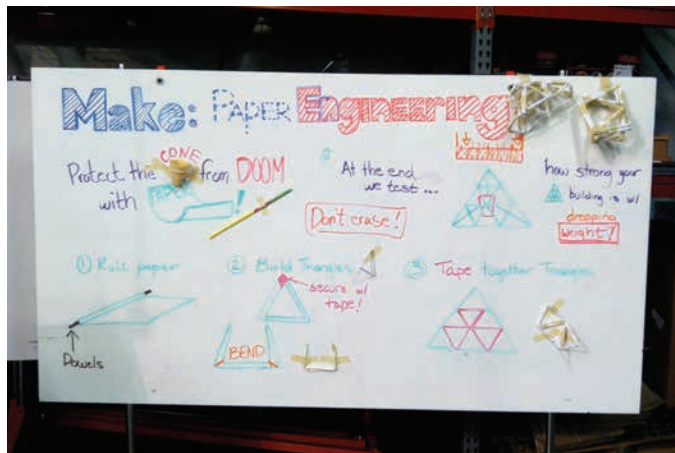
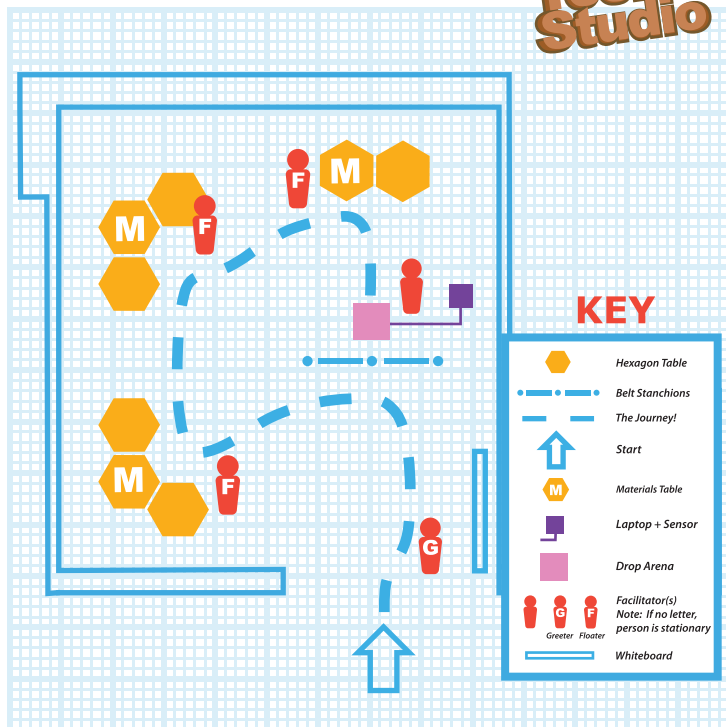

Whiteboard Explanation
 Posted the Design Challenge, a step-by-step construction of a triangle, and the process of a strong structure.



Troubleshooting

Paper Tech Support

If guests find rolling hard, get them to them to keep trying and at least make a basic sculpture from simple rolls. The idea is to get them to play with paper and start sculpting with it to explore the material of paper. Encourage them to stick with the challenge and keep going with their rolls. Have them add a piece of tape to the corner that's about to be wrapped around the dowel, and then when they make the roll they can apply the piece of tape to seal the roll. If they're continuing to have problems rolling rolls, have them do it with you. Start by tucking paper under the dowel, add a piece of tape to the paper, then have the guest's hands in the center to roll. Have them roll tightly while you have your hands on the outside, pressing down, and roll the dowel with them. It helps if you do it the first couple times so they get the idea when you work together.

Facilitation



Supporting through the Paper Engineering Process

Greet people in the front and lead them to the tables. Other facilitators should greet them when they get to the tables and show them how to create a roll. Once they learn how to make a tight enough roll, show them how to create a triangle. Learning the basics for this particular activity is simple: how to roll the paper and how to make a triangle. For constructing the actual structure guests determine what to make on their own. You may need to inspire guests with examples of what has been built, but this activity is very guest-driven. Let people know that their first few rolls may not be as tight as desired, but by the eighth try or so they'll be significantly better. Once guests learn rolls and triangle construction, they become self-reliant in their design. Walk around and see how people are doing. Show them other guests' examples if they are really struggling. Avoid showing too many examples, however, because you want people to come up with their own ideas. This leads to a greater diversity of design.

Ye Shall Be Warned!

Just for fun, leave the broken cones in the arena as a warning to other paper engineers.

Paper Engineering Collaborative

If a large school/summer camp group comes into the Makerspace, encourage them to build a

structure together. Have them become a paper design team and delegate different duties: someone tears tape, another rolls paper rolls, one converts rolls into triangles, and another person tapes all the triangles together.

Cone-Sized Cups as a Design Tool

Put small plastic cups nearly the size of the ice cream cones out on the tables so people can start to visualize how to protect the cone and leave the appropriate amount of space in their paper structure. Do not introduce the cups until guests learn how to make rolls. Once they start with rolls, move on to the cup and encourage them to start thinking about how to protect the cone/cup.



Teach Makers how to Rock their Rolling

Make a few rolls to showing the guests the difference between a tight and loose roll when the program begins. Guide them as they learn. Before the program starts have a surplus of few rolls made, start tearing tape, and leaving pieces on the table for guests to use. Build a few individual triangles and a basic structure composed of both loose and tightly rolled triangles to display various levels of strength. The trick is to not give too much away on how the most successful structures are constructed, but to teach them how to build effectively with the resources they have and they can iterate on how to make a city of paper structures.

Leading the Cone Crushing Arena

The weights themselves are made from sheets of paper wrapped with brown paper (kind of like a book). When guests come up to the testing zone, let them feel the weights and ask what they think about their structure surviving. Tell them the weights are actually just stacks of paper wrapped with paper—“paper vs. paper!” Paper can be strong in various ways and people will begin to see this. For additional comedic effect, we doodled “cone crushing” on the fronts of the weights. Before dropping the weights, make sure to clip or tape down the paper structures because they can bounce away when the weights are dropped on them. Be sure to ask the guests to stand back incase of bouncing weights as well!

We All Scream for Ice Cream

When about to drop, yell, “3, 2, 1...ICE CREAM!” If people are watching, ask everyone to count down with you. Give guests high fives when their structures succeed—or even if they don’t! The person dropping the weights should bring a lot of energy and enthusiasm. Getting everyone pumped up is key to this role. Be sure to have the floater switch with this person if they need to take a break. For an additional challenge, try dropping all 3 weights at once. One family made a structure so strong that it not only survived all 3 weights together, but also Lindsay standing on top of it.



More Design Challenge Ideas

“Ice cream damsel in distress,” “Protect the villagers!” Act out a scene of the cone in distress to get young makers engaged. Give people a rescue mission and have them build a structure to help save the cone people from destruction. Create a story to save the cone from doom and think about different kinds of design challenges that could pair with each story. Give an innovative prompt to build the paper structure through storytelling and improv fun.

Reflections

Cone-Crushing Secrets to a Successful Makerspace

Similar to Patriotic Projectiles, this program generated lots of positive feedback, excitement, and huge smiles from guests. Many guests stayed most of the 2 hours, and almost every guest stayed longer than 20 minutes. This program helped us figure out key elements to a successful Makerspace: setting up a compelling design challenge, encouraging self-facilitated, open-ended making (guests could create anything they wanted with the rolls), keeping kids and parents engaged, teaching science concepts, facilitating teamwork with strangers helping strangers, focusing on iteration and reiteration, providing space to fail and keep trying, celebrating failure, and having a sense of humor!

The Bonds of Ice Cream Cone Innovation

Such a simple making process is great for team-building—guests can take on duties such as tearing off tape, making rolls, bending triangles, building the structure, and testing it before it goes to the drop arena. This was a great family bonding activity, because families work together in a similar fashion to a family game night. The best

part of this program may have been the conversation about making that arose from each group. Guests learned some engineering along the way, but the power of this program came from open-ended learning and play.

Paper, Repurposed!

Playing with paper is another form of tinkering, but is the exploration of a single material to rapidly determine expertise. We gave a simple challenge of protecting a cone from dropped weights, but a hidden goal was to encourage tinkering with traditional materials in non-traditional ways. Paper isn't just for drawing on or wrapping with, but can be used for 3D problem solving. This program is open-ended learning, like Legos, but with a prompt. The prompt was saving the cone, but after playing with paper, guests could unlock its new potential—especially when they developed their skills working with it. Once they realize that rolling paper makes it seriously strong, they may start to come up with other things to do with it beyond our challenge. Great Learning for Guests!

The Comedy of Failure

In this Makerspace, we really demystified failure and even made it into a comical spectacle! We were worried guests might be too attached to their projects, but it turned out no one was upset and people were totally okay with their failures! Sometimes, they would succeed with 3 individual weights, but still wanted to crush it with all 3 at the end.

Great Learning for Guests

This was a great learning experience because guests learned a few things about structural engineering: paper's strength, adaptability, and cool things you can build from it. It was like building with homemade Legos!



Examples of Guests' Cone-Protecting Innovations

Deflection: Instead of making a solid and strong top, make a pointed tip or pyramid top with paper rolls aimed straight up. This causes the weight to completely slide off, so the structure doesn't have a chance to buckle under its weight. Have a pointed tip or triangular top with paper rolls aimed straight up in a pyramid shape.

Rolls Straight Up: Cut off the weak ends of rolls and have them point up. Angle them slightly up into a point, but with a flat top.

Double Paper Rolls: Roll with twice the paper to make even stronger rolls and triangles.

Lincoln Log Cabin: Make layered braces with rolls to make mini cabins. Layer rolls on top of each other to make a log cabin-inspired wall. This makes the structure a little bouncy.

Inflatables: Make a strong structure, and then make a paper inflatable underneath to help take the initial impact of the weight.



Resources

Egg Drop Project to Inspire our Reverse Paper Drop Program:

<http://www.instructables.com/id/Egg-Crush-Physics/#intro>

Learn about the strongest shapes through math in the city:

<http://www.mathsinthecity.com/sites/most-stable-shape-triangle>



MaKey CollaboThon



Facilitator's Key

 15 minutes (excludes wait time in between games)

 Ages 9 and up

 2 Guests per Demo Table
 6-10 Guests per Large-Scale Game

 Heavy facilitation



MaKey friends this week at Makerspace! Use a MaKey MaKey to complete electrical connections with others as you join together to face the ultimate collaborative challenge.

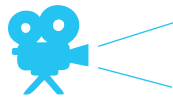

Blog Post, Video, and more Photos!

<http://www.thetech.org/about-us/tech-blog/makerspace-tech-makey-collabothon>

Ingredients

Technology

(6) 10-ft long alligator clips (long wires with alligator clips attached on the ends)
OR 50 small alligator clips linked together with electrical tape to secure them
 2 laptops **OR** 1 Laptop and 1 Standing Monitor
 2 MaKey MaKeys wired specifically for CollaboThon*
 1 projector

MaKey CollaboThon Processing Code:

<https://github.com/kguglielmino/TheTech/blob/master/ScoreboardTheTech3.zip>

Demo Table and Large-scale Game Materials

6 rolls of electrical tape
 8 boxes of tinfoil
 7 stanchions (6 stanchions for game buttons, 1 stanchion for the ground)
 2 rolls of masking tape
 1 roll of gaffer's tape
 2 colorful rolls of duct tape (Both must be different colors)
 (6) 10-ft rugs (for covering Alligator Clips/Wires)
 12 Sandbags

10 Soft objects to tinfoil per team

- Pool noodles
- Soft Foam
- Soft Spongy Styrofoam
- Hula hoops
- Foam swords
- Long Objects (Try to think soft!)



* See Additional Preparation of this Chapter



Goals

1. Guests develop "MacGyver thinking"—quick wit and resourcefulness.
2. Guests make and complete circuits with human chains and conductive materials as they learn some basics of circuitry, such as switches, conductivity, and ground.
3. Guests learn that people and tinfoil-covered objects conduct electricity.
4. Guests get moving, laughing, and playing collaboratively—and conductively!
5. Guests engage in a fun and friendly competition in a live-action video game.



Guests Served

We served 10 guests at a time for a total of 320 guests for the week.

Set-Up



Space Layout

This program requires a lot of set-up—leave at least 2 hours. Prepare a Demo Table showing the game on a small scale so guests can learn how to play the game before playing the Large-scale game. The Large-scale game takes up almost the entire Studio space. Set up the Demo Table and Large-scale game as in the diagram. The ground for the Large-scale game is a smaller stanchion that rests in the center of the entire field. It lies near the MaKey MaKey that's wired in the center. The MaKey MaKey connects to all 10 ft alligator clips and they are laid out according to the green thin lines on the Tech Studio diagram. The light green ovals are rugs placed over the alligator clips for safety. Before placing the rugs over the wires, make sure all cables are completely taped down to the floor. Place sandbags on the bases of each stanchion to keep them in place so guests don't push them around while playing. The cables are attached at the bottom of the stanchions just under the tinfoil, and need some slack in case of sudden movement. The alligator clips will clip to each individual stanchion along the chain. Put a second pair of extra long alligator clip chains under the rug in case of sudden breaks, but do not connect them to the stanchions unless the first alligator clip chain is broken.

Confused on Set-Up? Watch the Game!

<http://youtu.be/5XjZ2MFmYjk>

Invitations to Make

1. "Come play The Tech's latest game using the Makey Makey!"
2. "Want to take on a challenge that's all about conductivity and collaboration?"
3. "Work together to score as a chain of human circuits and tin foilyery!"

Present the MaKey Game

Guests use their bodies and various tin foiled objects as wires and score points by completing circuits.

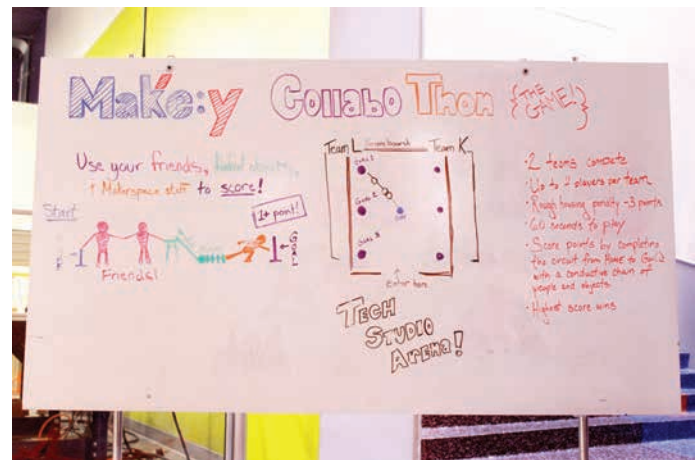
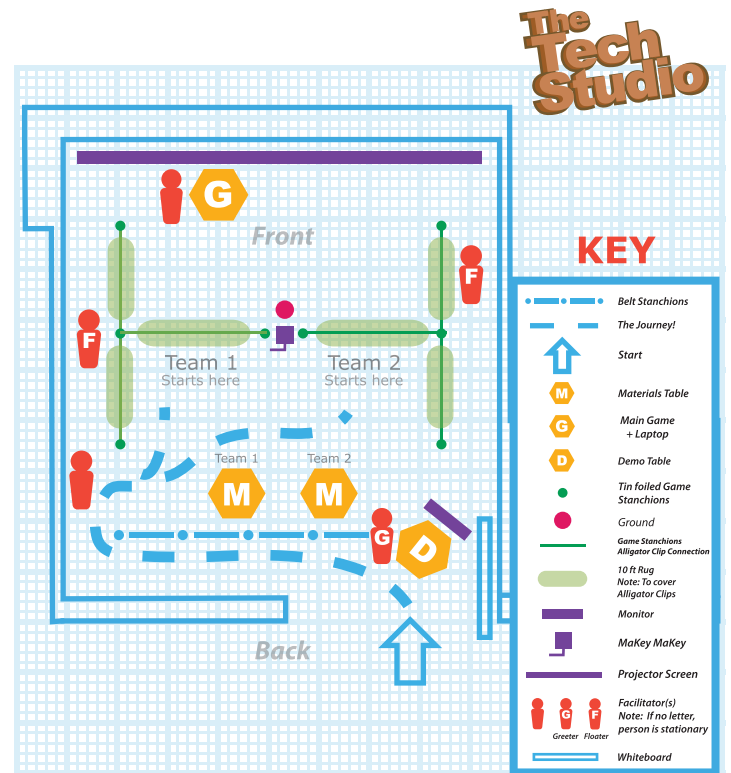

Whiteboard Explanation

Rules of the game and how the Large-scale CollaboThon game is set up with humans.

We have a Demo Table showing how the game works on a smaller scale so guests can learn how to play. Once they learn how the game works, they can take on the larger-scale game. To score points, they have to touch ground and connect to the stanchion that corresponds to the highlighted circle on the screen. As different circles become highlighted, they need to respond quickly and make their connection to the corresponding stanchion.



Troubleshooting

Securing the Stanchions

We had some technical difficulties with the hardware. There were challenges with the homemade 10-foot alligator clips due to the movement of the stanchions caused by guests getting really competitive during the game. The wires were thrown around because of the movement of the stanchions, which made it very difficult to keep them connected during the game play. The stanchions need to be stabilized with sandbags and kept in place. They can be taped down, but for the more competitive guests they'll need something stronger.

Facilitation



Getting Guests Started

While they're waiting for the Large-scale game, introduce them to the tin foiled objects that they can use along with their bodies to complete the circuit. To start the game, have someone pull guests in by having them try the small demo first, and then wait in line for the Large-scale game. They'll work together with the objects to become a human wire, but if they or the objects are not connected they won't complete the circuit.

MaKey Demo Table

At the Demo Table, show guests how the game works and explain the science behind the game. You don't need to explain all the science, but it's important to talk about the skin and conductivity. Tin foil and skin are both conductive. Clothes and shoes won't work. Let guests know that they have to constantly touch the stanchions in order for this to work. Establish this at the Demo Table so that when they play, they get the concept faster. It's very possible guests may not get into the game until they start the first round. It can be hard for them to get the game concept, but after the first trial run they will begin to understand.

Ways to Up the Challenge

Adding a high score makes a great addition. The guests' competitive nature comes out to make the game even more fun. Add elements to increase the challenge with select objects, having none at all if they are

high school students and older, or setting the timer to 30 seconds.

MaKey Teams

As guests wait in line, pre-determine teams before they play. Try to make teams as even as possible. We generally stuck to 3 people a team, following a rule of with 2 young kids acting as 1 full-sized adult. An example of another team dynamic could be a family of 5 with a 2-parent team and the 3 kids as 1 team. With large summer camps, have teams of 4-6 students. For older students, have a team of 3 with limited tinfoil objects. For larger groups, have them make a human chain of 5-6 people and no tin foiled objects to play the game. Once teams are established, let them figure out how to make connections. Give them 30 seconds to figure it out and help them if they are struggling. The goal is to let them figure it out, but give suggestions where needed on how they can connect with certain objects.

MaKey Player Roles

For players of the game, there are a few roles. The player at home has an easy job that involves rotating and moving slightly. The player in the middle moves slightly more, but the player on the outside has the most work to do. With larger groups, have multiple guests working together with 1 at each station and then moving a chain back and forth. We put the cap at 6 people, with no objects in hand just to make it more challenging and accommodate more people.

Guest's Strategies

1. A larger team playing without tin foiled objects had teammates stationed at the stanchions that grabbed the hand of the runner when it was time to connect.

2. A smaller team left tin foiled objects touching the stanchions and connected with really long objects by touching the chain of objects rather than reaching to the stanchions.
3. Another team made a long chain amongst themselves and various objects and moved the entire chain with them rather than leaving objects at the stanchions.
4. Another team figured out that the hula-hoop could go around ground, allowing the teammate holding the hoop to rotate without losing their connection.



Additional Preparation

Diversity of Conductive Objects

Find as many pool noodles to tin foil as possible! The variety of different conductive objects makes this challenge. All objects should be light and robust—Styrofoam is good. You can have multiples of the same object type, but try to have many different shapes. Wrapping everything in tinfoil helps bring the random objects together. It’s fun to use ridiculous objects to complete a circuit—a sphere, a long tube, a hula-hoop, and other random objects. It adds to the whimsy of the game to have such random objects composing a circuit.

MaKey MaKey Connections

Connect the keys of the MaKey MaKey according to the layout of the image at the bottom. The extra letters (S, A, W, G, F, and D) on the back of the MaKey MaKey are not needed to play the game so refer to the front side only. During our first day of programming we had problems with the MaKey MaKey CLICK button getting stuck in the “on” position. We programmed in these letters (S, A, W, G, F, and D) to press on the computer to give the stanchion point to a team as a failsafe in case we ran into issues again. The image below shows the controls to run the game we made in Processing. To the lower right corner of the image is the Game Master Control Keys to add, subtract, reset the game, and reset high score.

Team 1 (T1)		
Stanchion Position	On the MaKey MaKey	Computer Key (Override)
Front	Left Arrow	S
Middle	Space Bar	A
Back	Click	W

Team 2 (T2)		
Stanchion Position	On the MaKey MaKey	Computer Key (Override)
Front	Up Arrow	G
Middle	Right Arrow	F
Back	Down Arrow	D

Team 1
45
Team 2

0
High Score: 0
0

Left Arrow (S)	Front	Up Arrow (G)
SpaceBar (A)	Middle	Right Arrow (F)
Click (W)	Back	Down Arrow (D)

Game Master Control Keys on Computer

R: Run through Game Over Menus

0: Automatic Game Over

1: Team 1 (-3pts)

2: Team 2 (-3pts)

3: Team 1 (+3pts)

4: Team 2 (+3pts)

9: Set High Score to 0pts

Week
1
2
3
4
5
6
7
8
9

Reflections

MaKey Program Development

This program was originally made for the MaKey MaKey contest challenging MaKey MaKey-lovers everywhere to design a collaborative activity using the MaKey MaKey. We knew we wanted to make a game, but struggled with the concept. We finally settled on a simple game that turning into MaKey CollaboThon.

If You Build a Giant MaKey MaKey Game, They Will Come

This MaKey MaKey game was a great way for guests to show how they could think on their feet and make their mark at The Tech. There was really no need to convince people play—it sparked so much curiosity that people came and participated on their own whether they were playing both versions of the game or just the Demo Table. This game easily engages all ages, from really young kids to older students. Parents love competing against their kids and the college students have a blast playing against each other. The competition was good-spirited and really fun!

Makerspace Gets Physical!

This program was the first interactive and physical game we did over the summer. It was a nice change from the usual making projects because it allowed guests to display their creative improv skills as they connected and completed the circuit depending on how they worked together in a small or large group. All the groups played the game in their own way.

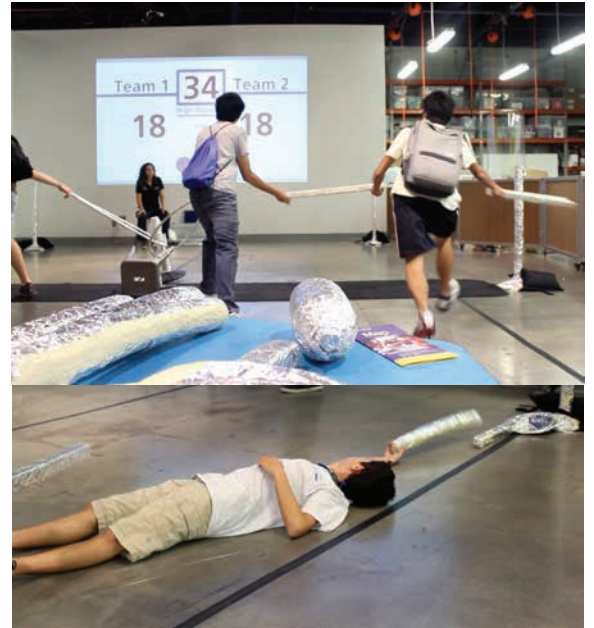

Improv Facilitation

This was our first Makerspace where crowd control was a must. We needed a good amount of facilitation and control for this program—from the Demo Table, breaking guests into teams, teaching them how to play the Large-scale game, establishing rules, and then letting them play the game twice to fully grasp the concept of human wires. The learning at the Demo Table can be completely controlled and translates really well to the Large-scale game. The game can be adapted in many ways: having 1 person on each side hitting each stanchion with tin foiled objects, learning how to work with major disadvantages, finding a way to include someone in a wheelchair, playing with a 20-person summer camp, and so much more.



Resources

Maker Kenny's MaKey CollaboThon Processing code:
<https://github.com/kguglielmino/TheTech/blob/master/ScoreboardTheTech3.zip>

Video of Makerspace guests playing MaKey CollaboThon:
<http://youtu.be/5XjZ2MFmYjk>

MaKey MaKey:
<http://www.makeymakey.com/>

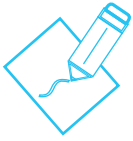

Special Note:

Aerial Antics and UFOs, Weeks 7 and 8, are combined in the Cookbook due to similarities in materials, facilitation, and reflections. UFOs is an expansion of Aerial Antics using LEDs, long-exposure photography, and Glowdoodle. If you choose to do UFOs, look at both programs to create the full experience. If you choose to do Aerial Antics review the material for that only.

Aerial Antics

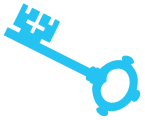

Facilitator's Key

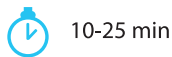

10-25 min



All ages



Solo or 2-3 guests
per group



Light facilitation



Are you a fan of flight? Play with aerodynamics as you build and test many different floating forms that hover and spin in our Makerspace wind tube. See what aerial shenanigans your creations can perform!



Blog Post, Video, and more Photos!

<http://www.thetech.org/about-us/tech-blog/makerspace-tech-aerial-antics>



Overall Goals for Aerial Antics and UFOs

1. Guests develop the mindset of iteration as they build, test, redesign, and retest their hovercrafts to figure out what shapes hover best in the wind tube.

2. Guests learn some basic aerodynamics through this trial and error process.

3. No matter how many iterations it takes, guests have fun as they design multiple versions of their hovercrafts until they find the design that hovers the way they want.

4. For UFOs, guests learn the concept of light painting through long-exposure photography and get to experience the merger of art, science, and technology.

Ingredients

Have 2 Wind Tubes

To make 1 wind tube:

- 30 long Thinker Linkers wooden pieces
- (20) small 90-degree Thinker Linkers pieces
- 35 large zipties
- 4 wooden paint stirrers
- (6) 4-foot x 2-foot polycarbonate sheets
- 1 rivet gun
- (20) 1/4" rivets
- 2 rolls of double-sided clear adhesive tape (that can hold at least 5 lbs)

Hovercraft Materials

Materials listed below are for **both** Aerial Antics and UFOs hovercraft building.

- | | |
|------------------------------------|--|
| 300 large and small coffee filters | 400 pipe cleaners |
| 100 sheets of blank paper | 40 ping-pong balls |
| 100 sheets of construction paper | 25 ball pit balls |
| 12 washable markers | 25 rolls of masking tape |
| 200 Dixie paper cups | 50 pieces of cardboard packing peanuts |
| (5) 48" sheets of vellum | 20 pairs of scissors |
| 20 Pink Pearl erasers | 5 rolls of colorful string |
| 300 strawberry baskets | 150 Snapple metal caps |
| 100 take-out boxes | 150 plastic bottle caps |
| 200 soft foam cubes | 300 binder clips in small to large sizes |
| 20 sheets of tissue paper | Tons of containers to hold all of these materials! |
| 300 colorful straws | |

UFOs *(Unique Flying Objects)*



Facilitator's Key

 20-30 min

 All ages

 Solo or 2-3 guests per group

 Medium facilitation

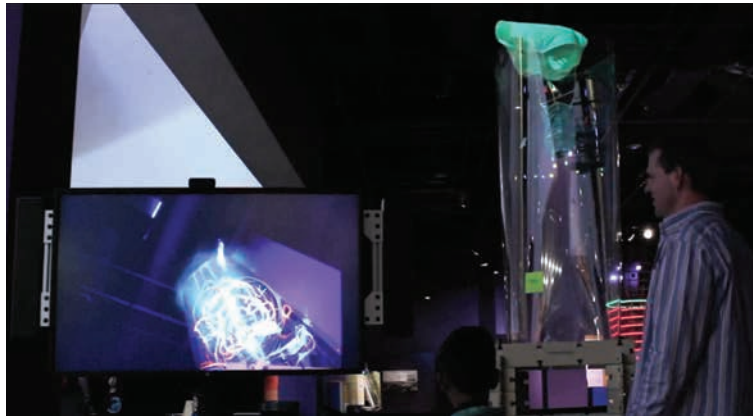

Can you craft a unique flying object that paints The Tech Atrium? Test and iterate your UFO to make it fly in wacky patterns. Use long-exposure photography to capture light paintings with the LEDs on your UFO.



Blog Post, Video, and more Photos!

<http://www.thetech.org/about-us/tech-blog/makerspace-tech-ufos>

Ingredients

UFO (Specific Materials)

200 6-oz clear plastic cups
200 clear plastic condiment cups
10 large sheets of bubble wrap
20 inflated plastic packing material
300 small rubber bands
100 colorful zip ties
150 Easter eggs
8 rolls of cellophane wrap
250 LEDs
250 3V lithium batteries
300 sheets of sticky notes
2 Sharpies

Place to post UFO light paintings

Facebook page
Imgur
Photobucket

Light Painting Set-Up

Pick between set-up options #1 and #2. We did both to experiment, but select one that works best for you. Regardless of which set-up is chosen, install **GLOW DOODLE** on the computer.

Set-Up #1 - DSLR Camera*

DSLR camera
Camera cable with USB port
Standing Computer Monitor or TV Monitor
Tripod
1 small piece of dark blue vellum
To place on the camera lens as a filter if too much light is present in the room

Set-Up #2 - Laptop Webcam

Laptop with Webcam attachment
A cable to connect laptop to TV/Computer/Projector*
Standing Computer Monitor or TV Monitor
1 small piece of dark blue vellum

 * See Additional Preparation of this Chapter



Guests Served in Aerial Antics and UFOs

We served 40 guests at a time for a total of 888 guests for both program weeks. We also served 1,500 guests at The Tech Museum's members party, plus the 320 guests we served our for a Makerspace encore, we served 2,708 total guests with these two programs combined!

Aerial Antics Set-Up



Space Layout

Note: If only doing Aerial Antics, disregard UFOs set-up on next page. If doing UFOs, it is Aerial Antics PLUS UFOs set-up, but one wind tube is now in the Atrium instead. See information on next page for UFOs.

Place 2 materials tables on opposite ends of the room to prevent overcrowding. Place making tables in the middle. Place wind tubes near each other, with the openings of the tubes both facing out, so separate lines can form for each tube. Have 1 person stationed at each tube to help guests with their testing, and 1 person at the front to greet guests and share the design challenge. That leaves 1 person to roam around connecting with guests at the working tables.



Invitations to Make

1. "Create a hovercraft that stays afloat inside our wind tubes. Try to not let it fly out!"
2. "Do you want to make something fun to float inside our wind tubes?"



Present the Making Activity

The goal is to design something that hovers inside the wind tube rather than flying too high and shooting right out of the top of the tube. Create hovercrafts that stay afloat inside the wind tube with a good balance of weight to keep the hovercraft in the center.

The
Tech
Studio

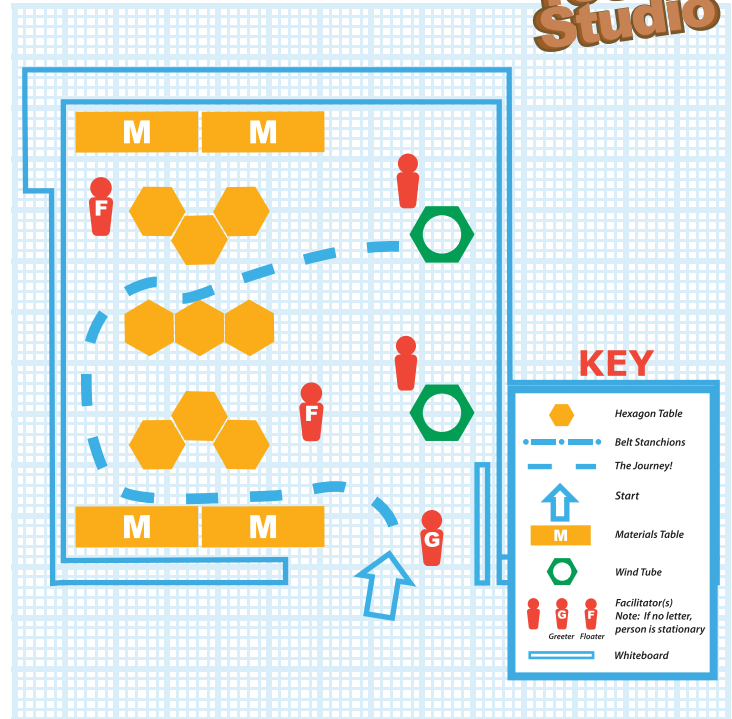

Whiteboard Explanation

Graphic narrative of the design challenge to keep the hovercraft within the tube!

UFOs Set-Up



Space Layout

Note: UFOs set-up is Aerial Antics PLUS UFOs.

Use both wind tubes again, but place 1 tube right outside the Tech Studio in the darkest part of the Atrium, but near Tech Studio with the other tube. You may have to ask staff to adjust the lighting. Set up 2 screens next to the tube outside the Studio with 1 connected to Glow Doodle and the other displaying the 10-second long-exposure photograph. Glow Doodle will allow guests to watch their hovercraft's tracks as they are being made. The long-exposure photographs will not show any tracks until after the flight is over, but the resulting image of all the tracks will be much more colorful and defined. Place stanchions around the second wind tube outside the Studio with an opening in the back for guests to wait in line.



Invitations to Make

1. "Design a hovercraft with LEDs and keep it afloat inside our wind tube to make a light painting. The longer it floats inside the tube, the cooler the light painting."
2. "Do you want to create a UFO, short for Unique Flying Object? Light up your UFO, and it creates a light trail wherever it travels."
3. "Make a glowing hovercraft, and then take it to the "flight painting" tube that captures your craft's technological tracks as it flies."

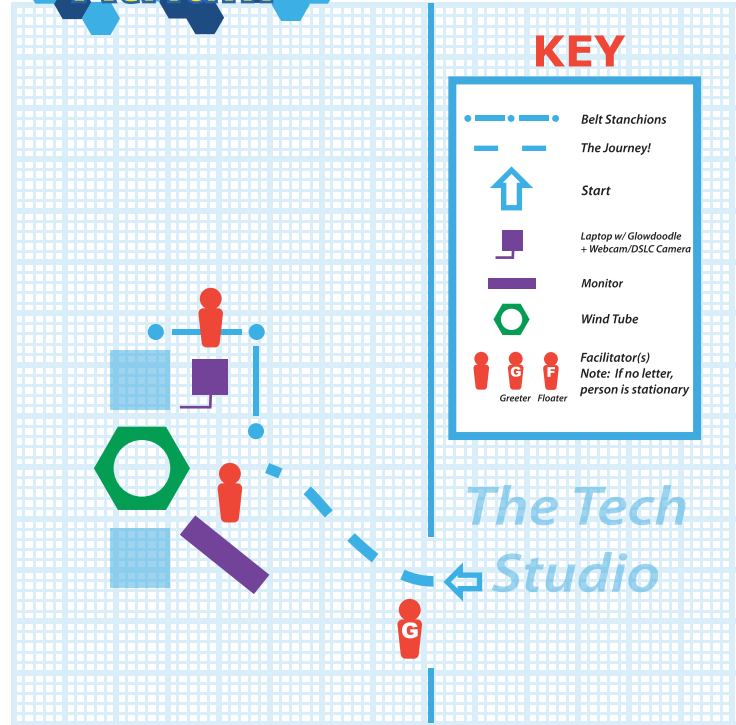

Whiteboard Explanation

Graphic narrative of how to light up a hovercraft and take a photo of guest's light paintings!



Present the Making Activity

Create a UFO by making a hovercraft with LEDs attached. Bring it to the first wind tube to see how it flies. Once you like the flight path it takes, bring it to the second wind tube outside in the dark. You can place your UFO inside the tube and watch it create a light painting! We capture your UFO's technological tracks on a giant screen so you can see how it flies.



UFOs Troubleshooting

Blurry Photographs

Did you accidentally bump the tripod? Is your space dark enough?

Too Much Light

If there is too much light in the photo, place a small piece of transparent dark blue vellum to act as a dark filter on the camera lens.

Mistaken Identity

To tell the difference between UFO light painting photos add a sticky note to the tube with the name of the person or name of the hovercraft!

Aerial Antics & UFOs Facilitation



Greeter Directs All

The greeter keeps this program running smoothly and plays the biggest role of UFOs in particular. Guests don't need much making support, but they do need to be directed to the materials table, the test wind tube, and for UFOs, to the wind tube outside The Tech Studio. The greeter maintains guest flow, answers guests' questions, and introduces the design challenge to guests as they pass by. For UFOs, the greeter lets guests know after testing their hovercraft in the wind tube inside Tech Studio, they can go outside into the Atrium to the wind tube in the dark for light painting. They also make sure guests know from the start that they can't take the LEDs home, but are welcome to take their LED-less hovercraft. Say to guests, "Please leave the LEDs for future innovators!"

Facilitating at the Making Tables

This program was a test to see how far guests could go with a buffet-style materials table and little facilitation at the making tables. The facilitation for this program comes much less at the making tables, and much more at the wind tubes after testing, asking questions about why something hovered or didn't, and giving encouragement to redesign to maximize hovering. For UFOs, walk around and share

strategies for making cool effects as they light their UFOs. They won't know what different styles of lighting will look like until after they finish their light paintings. Easter eggs have a nice glow when LEDs are placed inside. They alter the quality of the light painting, but look cool and can be a nice holder for the LEDs as they move. Pipe cleaners are great for using as string to hold LEDs. Bubble wrap adds a nice element because it's light, transparent, and has a lot of qualities for shaping. Let guests know that different types of UFOs make different styles of light paintings based on how they hover. They should aim to hover a little higher than the stand/base to capture the light. There's slightly less emphasis on the hovering for UFOs, but it is still key because if their UFO floats out of the tube really fast it might be hard to photograph. However it could make a cool effect too! Really energetic pieces make for great photos since so much goes on in the tube.

Choosing Your Materials for Guests to Experiment

The materials out on the tables will affect the kinds of hovercrafts guests make. Containers like strawberry baskets and take-out boxes give guests a great start to hovercraft building because they have a solid shape and can hold some good weight from straws, pipe cleaners, etc. With materials like tissue paper and coffee filters, many guests are tempted to make parachute structures, which are fun, but become commonplace in design. When we took away coffee filters, we saw some major changes to the types of hovercrafts guests made.

Having tons of straws, cardboard peanuts, rubber bands, and zip ties helps encourage guests to create different designs. Experiment with different kinds of materials on the tables to get different results from each crowd of guests.

Facilitating at the Wind Tubes

Lines at the wind tubes can grow long. Have guests form a line coming from 1 side of the wind tube and keeping the other side clear for the facilitator to access. Let guests place their hovercrafts inside—1 guest at a time so they can see their hovercraft's aerial potential! If hovercrafts have long tails, make sure they don't get caught on the fan or base. If hovercrafts get caught at the top, turn off the fan to let it float down to the bottom. Have a pole to poke at the top of the tube if hovercrafts get stuck up there. You can also poke the tube itself to shake the hovercraft down. Much of the facilitation at the wind tubes happens when guests begin to see where their pieces succeed or fail. Sometimes it's a quick fix and other times they need to make major adjustments. After the test, ask guests what they thought made their crafts hover or not, and encourage them to modify their design to make them hover longer. Be encouraging of guests' designs and recognize specific design elements that make them hover (or not!) in cool ways and lead to hovercraft success - or failure. Once they see how too low or too high their hovercraft flies and look at how some of the other guests' hovercrafts fly, they see the variations of designs that work and those that don't. Maybe there's not enough lift, without any parachute, airfoils, or wings. Perhaps it's too light or too heavy

with weights. Make suggestions to get them thinking about their next iteration. Celebrate hovercraft failures as learning opportunities for guests to learn what really flies!

Additional UFOs Facilitation

Facilitating the UFOs Light Painting Wind Tube

Start with 2 facilitators: 1 person places UFO hovercrafts inside the wind tube and helps identify guests' UFOs by writing by writing the name of the hovercraft on a sticky note and placing it on the tube that shows within the frame of the camera. If guests don't have a name, encourage them to come up with something fun! This allows guests to identify their DSLR light painting on The Tech's social media page. For Glow Doodle, an exact time is the only way to identify a UFO, as guests won't be able to see writing or the actual UFO at all. A person lets go of the hovercraft in the tube while the other person is stationed with the camera (whether webcam or DSLR camera) for Glow Doodle. When they're finished, remind guests to return the LEDs and batteries to the materials table before they take their hovercrafts home. It helps to have a couple bins for guests to recycle their projects too.

Lighting Things Up at the LED Table

Have a person at the LED table, primarily attaching LEDs to the batteries to keep up with the demand of guests. If it's a small crowd then have guests light up the LEDs by showing them how to connect them to the batteries.

Introducing Light Painting

Light painting is a result of long-exposure photography and is maps the trail of the LEDs on the UFO hovercraft in slow motion. The webcam camera connected directly to the monitor to shows a single color map where the hovercraft is currently flying in Glow Doodle until the picture is taken with the spacebar on the computer. With the DSLR camera, it captures a higher quality light painting that grabs individual LED colors and trails, but doesn't show the process of the hovercraft flying until the end of the exposure period. The camera takes much higher quality 10-second exposure photos. The UFOs are like artbots in the air, but instead of markers for legs they paint with light as they go!

More on How Light Painting Works

How does the camera take a picture of the moving lights? Long-exposure photography keeps the f-stop open for a long time, tracing the lights and "painting" the hovercraft's path. Guests get to "paint" their unique technological trails depending on how their craft hovers. Some crafts bounce around so their lights are sporadic, while others fly around in a more graceful path with their lights tracing out smooth circles as they go. We found that the red LEDs did not show up as brightly as many of the other colors.



Additional Preparation

A Place to Store and Share Photos!

If the light painting set-up is DSLR create a Facebook page, Imgur account, or Photobucket to store photos and for the world to see! If taking photos from just Glowdoodle, make sure to keep track of the time each photo is taken because it's hard to find whose photo is which when it's stored online.



Maker Kenny's DSLR Camera Instructions

1. If you are not familiar with your camera, check out the camera's user guide. Also, basic knowledge of how a camera functions will help:

http://www.dpchallenge.com/tutorial.php?TUTORIAL_ID=45

You will have to know how to change aperture, shutter speed, and ISO.

2. Put your camera into manual mode.

3. Depending on the space, you will need to adjust your camera accordingly. Outside The Tech Studio we had a Canon t3i, set at 100 ISO, F22 Aperture, and 10-second shutter speed.

4. Place your camera on a tripod. It is crucial that the camera does not move while you are taking the picture.

5. Connect your camera to the monitor. Depending on the camera you are using, it may be a different process. For Kenny's camera, he used a mini-HDMI to HDMI cable.

6. Now take photos! While the camera was connected to the monitor, there was about a 10-second delay between when the photo finished and when it appeared on the screen.

Reflections

What a Fun Crowd!

We drew a Paper Engineering type of crowd, with guests getting really into the making. The tube displays were stunning, so this program didn't need much coaxing to get guests making hovercrafts. While the design challenge was to create hovercrafts that could stay afloat inside the wind tube with a good balance of weights to keep them in the center, sometimes guests had more fun making hovercrafts that purposely flew out. That's okay too! It was fun to see what guests came up with and both Aerial Antics and UFOs drew really fun crowds.

Materials for Inspiration

The projects that emerged from both of these programs were very materials dependent, which was a first for our Makerspace program. As with Paper Engineering, we had examples, but it's better to let guests see all the materials available and come up with their own ideas from there. There wasn't much of a need for us to inspire creative hovercraft designs, but rather show examples after people made their first hovercrafts to help with problem solving and coming up with potential solutions for their next iterations.

From Aerial Antics to UFOs

Aerial Antics inspired UFOs, with an additional learning goal for UFOs. Aerial Antics was a hovering design challenge with weights, while UFOs also focused on the science and technology of light painting as the crafts hovered in our light painting wind tube. Each program worked a little differently, but both are

powerful programs for guests involving lots of making, some good science and technology concepts, and plenty of iteration.

Further Program Riffs

UFOs was the first program that was Kenny and Lindsay-driven and that we can call our own. We were inspired by some of the artbot and wind tube innovations we had seen at other museums. We thought it would be cool to combine them by innovating artbots in the air! This program has inspired the Star Wars-themed Hands-On Science Workshop. When we were trying to figure out how we could connect UFOs to the Star Wars theme, and just when we were about to go in another direction, a guest came in with the origami Yoda that he made into what he called a "Yoda Floata". He said that if he'd brought his origami Darth Vader, he'd have made a "Vader Invader"! We took this as a good sign for Star Wars + UFOs, and after more brainstorming with Kenny, Lindsay, and the Gallery staff we came up with the idea to use sensors and actuators to allow guests to leverage "The Force" as they control the movements of their glowing hovercrafts with a wave of their hands.

Design Challenge Ideas from a Teacher

Draw a line on the wind tube so guests have a target for their hovercraft to hover around. Think about many types of challenges for kids to make a versatile hovercraft that can complete a series of them!



See UFOs light paintings!

Makerspace Day 1

<https://www.facebook.com/media/set/?set=a.654915364521062.1073741858.123560980989839&type=3>

Makerspace Day 2

<https://www.facebook.com/media/set/?set=a.655752624437336.1073741859.123560980989839&type=3>

Makerspace Day 3

<https://www.facebook.com/media/set/?set=a.657445280934737.1073741860.123560980989839&type=3>

Makerspace Encore:

<https://www.facebook.com/media/set/?set=a.661228130556452.1073741863.123560980989839&type=3>

Wind Tube Innovation

Aerial Antics is custom in terms of how we built our wind tubes. The main goal was to come up with a design on a short deadline, but what we didn't realize that we had everything we needed for our solution right in front of us. The wind tube guide from the Tinkering Studio at the Exploratorium inspired us. We expanded on that idea by reconstructing the base to be taller, have a more powerful airflow, have a window for easily placing hovercrafts, and ultimately create a stunning presence. We found all of the materials in The Tech Studio to reconstruct the base other than the polycarbonate plastic for the tubes. We worked together to solve problems along the way—how to elevate the fan from the ground for powerful airflow, what to make the base out of, how to hold the tube to the base, how to build with minimal tools, and more. We started with cardboard as the base, but decided to move to Thinker Linkers as a stronger and more customizable support for the tubes. That really started our innovative process, and from there we began to come up with more solutions—paint stirrers to hold the tube to the base, zip ties to lock the Thinker Linkers in place, and dowels to hold the fan and lock into the notches of the Thinker Linkers.

The Evolution of the Whiteboard

The whiteboard for UFOs reflects how Lindsay has developed in interpreting the design challenge using her drawing skills. She created a step-by-step visual of the entire program experience. The whiteboards have evolved from a simple how-to illustration into a narrative of the program. They help set the tone for the combination of a classroom feel and a casual learning space for people to start making. They set the stage for a



fun learning space with open making! The sense of humor has evolved greatly from the first couple of whiteboards into comic book-style narratives.

Makers are Learning Too!

The Aerial Antics and UFOs programs are showing us how experienced we are and what a great handle we're getting on Makerspace. So far we've had different bits and pieces of learning with each Makerspace program, but these programs combined everything we've learned without needing to make major adjustments. We've finally gotten our program development methodology down. Plus, the UFO program was an innovative way to incorporate Kenny's photography and technology talents with Lindsay's whimsical material-based making!



Resources

Vertical wind tube tutorial:

http://www.exhibitfiles.org/vertical_wind_tubes

Exploratorium Tinkering Studio wind table:

<http://blogs.exploratorium.edu/tinkering/2012/06/22/cales-wind-table-flyer/>

More on the Exploratorium's wind tube:

<http://tinkering.exploratorium.edu/wind-tubes/>

Soaring Satellites:

<http://legacy.mos.org/designchallenges/challenge.php?dc=satellites>

Glow Doodle:

http://scripts.mit.edu/~eric_r/glowdoodle/index.php

Maker Kenny's camera instructions:

See Additional Facilitation of UFOs

General knowledge about DSLR cameras:

http://www.dpchallenge.com/tutorial.php?TUTORIAL_ID=45

Long-exposure photography tutorial:

<http://www.howtobecomeaphotographer.biz/night-photography-tutorial-long-exposure/>

What we used to quickly build the wind tube bases! Thinker Linkers kit:

<http://www.murrahwoodcraft.com/pages/thinker-linkers-main.php>

Wild, Wild Tech



Facilitator's Key

- 30-40 minutes - for 2 full projects completed
- Ages 10 and up
- Solo or 2 guests per group
- Medium facilitation



Take aim at making at our last Makerspace program for the summer. Create paper targets then try your luck at creating your own launcher to knock them down!



Blog Post, Video, and more Photos!
<http://www.thetech.org/about-us/tech-blog/makerspace-tech-wild-wild-tech>

Ingredients

Target Holders for the Practice Range + Shooting Gallery:

- | | |
|--|---------------------------------|
| 3 kits of Buildopolis cardboard fort kits | 1 hot-glue gun |
| 1 roll of string | 6 glue sticks |
| 2 large tablecloths | (10) 1/4-inch dowels |
| 2 different color tablecloths for cutting | 2 rolls of colored masking tape |
| 4 rolls of colored duct tape | |
| 1 small 1-inch thick sheet of insulating pink foam | |

Ping-Pong Launchers:

- | | |
|---|---|
| 300 thick rubber bands | 300 pencils or empty pen cases |
| 300 latex-free rubber bands | 200 pieces of cardboard packing peanuts |
| 200 ping-pong balls | 200 thick-ply small cardboard tubes |
| 5 special heavy-duty hole punchers | (to fit inside the large tubes) |
| 8 regular hole punchers | 200 thick-ply large cardboard tubes |
| 200 small binder clips (various colors) | 200 paper cups |
| 200 large binder clips (various colors) | 150 soft foam cubes |
| 10 rolls of masking tape | 100 sheets of heavy cardstock |
| 10 special scissors for cutting cardboard | 500 plastic spoons |

Paper Inflatables:

- | | |
|---|---------------------------------|
| 300 sheets of colorful construction paper | 20 scotch tape rolls/dispensers |
| 300 sheets of colorful paper stationery | 20 washable markers |
| 20 rolls of masking tape | 20 pairs of scissors |
| 15 1/4-inch dowels | |



Goals

1. Guests develop innovator's skills and mindset as they iterate on their slingshot designs using whatever they can find from the materials table.
2. Guests learn how to make paper inflatables that make a challenging target to hit for others and create a slingshot that launches a ping-pong ball.
3. Guests design innovative launching solutions to tap into the power of potential energy.



Guests Served
 We served 20 guests at a time for a total of 420 guests for the week.

Set-Up



Space Layout

Have a materials table holding materials for launchers and paper inflatables. Arrange tables in 2 long lines with bins of hole punchers, masking tape rolls, and scissors for both projects. In the back against the wall is the Practice Range and Shooting Gallery. The Practice Range consists of simple targets for testing if the ping-pong launchers work at all. The Shooting Gallery is where you can place your paper inflatable and knock them down with the launcher. Around both the Range and Gallery curl cardboard up against the wall to the floor so the ping-pong balls roll back to the front rather than gather in the back for the facilitator to gather easier. Create a fence of cardboard around both the Range and Gallery to prevent the ping-pong balls from rolling away. Set out bins of safety goggles and let guests know to wear them at all times when they are launching. Keep bins full of ping-pong balls and refill them when depleted. Always call for a cease-fire before you gather ping-pong balls!



Invitations to Make

1. "Welcome to the carnival! Create a ping-pong launcher and take aim at a paper inflatable of your own design."
2. "Come create an innovative target to place in our Gallery Range! Make a slingshot and take aim at your target."



Present the Making Activity

Create 2 projects! First make a paper inflatable using paper, tape, and a straw.

The
Tech
Studio

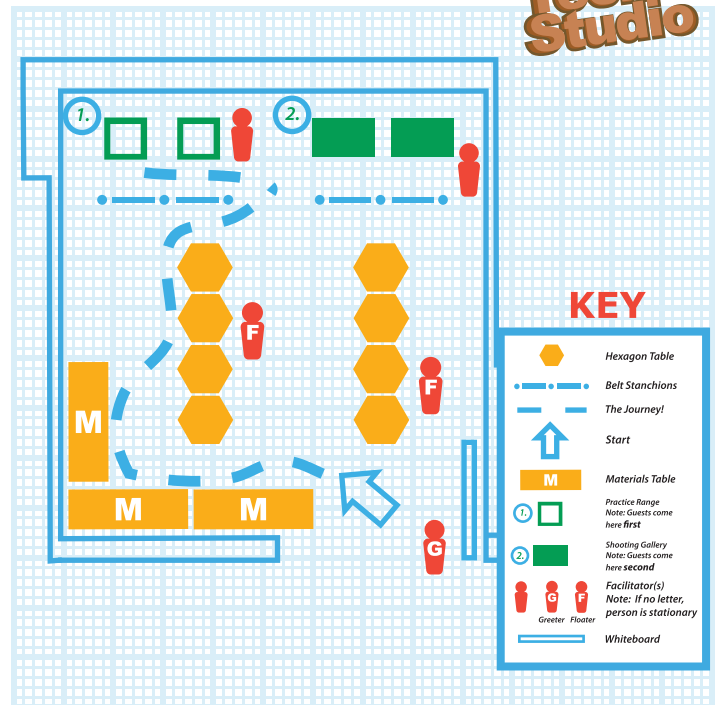

Whiteboard Explanation

Graphic narrative of the design challenge and introducing both projects.

Then make a ping pong launcher, or a type of slingshot, made of supplies from our materials table. Feel free to test your slingshot at the practice range and once you're ready, take aim at your paper inflatable at the Gallery Range where you can knock down multiple targets.



Troubleshooting

Slingshot Support

Some guests need direction in their process, including how to start. Giving them questions to work with is a very effective way to introduce them to the process of designing a slingshot. Good questions to help prompt the design process: “Where is the ping-pong ball going to go?” “How will the slingshot hold it?” “How will it launch?” This is a similar iterative process to Patriotic Projectiles, but a little more advanced and open-ended. Instead of having a standard design for all to make, have some examples of some types of slingshots (catapults, spoon launcher, etc.), but encourage guests to adopt other ideas and incorporate them into their designs. Many guests were making the traditional type of slingshot, but with support and encouragement came up with new designs. This program allowed us all to practice how to approach guests and facilitate while not giving them the right or wrong way to make a slingshot. Give them lots of space to try things, encourage them to try innovative solutions, and then ask questions to guide them toward a solution that might work. Guide guests to a solution that might work and work from there.

Facilitation



Wild, Wild Greeter

An enthusiastic greeter always increases numbers and chances of people engaging by providing someone to connect with guests as they come into the space. The greeter introduces guests to the activity, makes sure the guests see the galleries and testing stations, and lets them know there are 2 projects and they must make both to play at the Range and Gallery. The greeter directs guests to the materials table and tells them to work on 1 project at a time rather than gathering everything all at once.

Knowledgeable Facilitators

All program facilitators need to know how to make paper inflatables and have a few ideas for how to get started on a slingshot. Floaters float between stations and introduce the activity to guests. “Which one do you want to make first? Paper inflatable targets or slingshot?” Explain why they need both. It’s twice the design challenge! All facilitators not at the Practice Range or Shooting Gallery are floaters, but should switch out with them since it can be to repeatedly pick up ping-pong balls.

Shooting Examples

Show many examples of slingshot design rather than just 1, so guests know there are a variety of ways to make them. Guests only need examples

when they aren’t sure where to start, even after they get their materials. It’s good to show a paper inflatable, because some guests can easily forget how to make a target or what a paper inflatable is altogether!

Slingshot Making

For the slingshot activity, let guests gather materials and figure out what to do. It should be a combination of self-facilitation and to support when needed. Let guests know that they are completely free to go up to the Practice Range and test their slingshots out at any point. This way, they can tinker and see what does and doesn’t work very early on. Facilitators may have to step in to help cut cardboard tubes or punch holes because it can be difficult with normal hole-punchers and scissors. For safety reasons, keep an eye out for this since some guests may try to dig and burrow holes into the cardboard tube using the point of the scissors!

Inflatable Making

Slingshots are very open-ended, while paper inflatables are made in a specific way. For inflatables, let guests know they need to create a paper roll (the same paper roll from Paper Engineering) that holds the paper inflatable up at the Gallery Range. Paper inflatables needs more facilitation and direction so if someone is starting the process of making one, come in and provide an example of the process. If possible, gather a bunch of people and show them all at once. Have them all grab 2 sheets of colorful paper (both sheets don’t have to be the same color) and start by taping a small piece of masking tape along the edges of the paper to keep both sheets together. The 2 sheets can be

either landscape or portrait, but starting landscape is easier. Let the guests know that they can draw anything on one side. Give them a prompt like an alien or monster! Once they start the drawing, advise them to leave space around their drawing for taping and not cover their drawing! The easier it is to cut out, the easier it is to tape. The tape at the top of the sheets of construction paper kept them set so when guests cut out the shape it was the same shape all around. Once they finish cutting the shape, make sure there is space all around the actual drawing and show them that before they begin taping all around their drawing they must make a paper roll and tape it between the 2 shapes. This is also to ensure they don't forget to add the roll. Let them know that if there is an air leak it might be escaping from those specific corners. Once the roll is placed, show them how to tape around the entire shape. Help them tape it between the 2 shapes and make sure they seal the tight corners well. Guests can choose to use masking tape, which is much easier to see and use, or place scotch tape all around if they want the tape seal to be invisible. Once it's taped all they way around, tell the guest to blow into the inflatable and see if it fills. If not, tell the guests to blow inside again and feel for air escaping somewhere, then tape it off until it completely inflates. To keep the inflatable permanently inflated, guests must pinch along the lines of their drawings and flatten the edges. This is why they need to leave enough space around their actual drawings. They can see their drawings best this way, and the edges allow for the inflatable to expand. Note that guests can also have their targets not inflate, but it makes it harder to hit, since when the ping-pong ball hits, the target sometimes spins.

Facilitating the Shooting Gallery

For safety, the space in the very back is where the Practice Range and Shooting Gallery are. Each have 1 person at all times. Facilitators at these stations must wear goggles at all times to let guests know that they have to wear for safety. Ping-pong balls are safe, but the goggles are more for rubber bands snapping or recoil from a pencil breaking. You'll need to stop guests from shooting on occasion to pick up ping-pong balls. Tell guests to cease fire when needed to uphold safety measures. Tell guests to take turns—up to 2 or 3 people at a time. Overcrowding can make things difficult and hard to aim. Some slingshots might be designed to have more space surrounding the shooter (pulling back the spoon, the launcher, etc.). Have guests' space out and make 2 lines for the practice range. Have the line go down the center of the room between the 2 tables. At the Gallery Range, facilitators will have 1 person per station at a time. Several paper inflatables will be around the gallery to fill up the spare targets. Let younger kids know that the 3 targets in the back are little higher and farther back from the first 2. Give guests 10 or 15 balls to shoot with, but if there is a long line no more than 10 balls.

Reflections

The True Makerspace Prize

The best part of this program was that even if people didn't hit the target, they loved shooting things they created! Let guests know that they can keep their inflatable and slingshot. The paper inflatable becomes kind of like a stuffed toy prize from the carnival.

Paper Inflatables vs. Paper Switches

This Makerspace was relaxed, like Paper Engineering, with everyone floating and supporting the making, other than the range facilitators. Making paper inflatables was much more laid back than making switches in Switch It Up. For the switches, we had to not only show guests how to make the switch, but also how to add the electronic component of copper tape, and encourage them to make a creative, origami-style switch rather than the standard open/close type of switch. Inspiring creative designs was easy for the paper inflatables because there was direction, a creative and personal element, and a unique method of playing with the paper.

Open Source Shooting

This program succeeds at creating a Makerspace environment in which people start designing and sharing their process—lots of open source learning and sharing. Guests ask each other questions such as, “How did you do that?” and share expertise and experience with one another. These design challenges gets guests to understand different engineering scenarios: how to hold a ping-pong ball, how to increase or decrease power, how to aim straight, how to play with the range, etc.

Safety Goggles

The colorful goggles were a nice touch to make safety fun. They were another great way for Makerspace to celebrate failure, while making safety much more colorful and fun.

How We Came Up with the Shooting Gallery

It was interesting to figure out how to facilitate 2 different projects. Both projects, slingshots and paper inflatables, were both the result of having a day of play the week before. Kenny and Lindsay each spent an hour working on very different projects. Kenny made launchers, slingshots, mini-cannons, and tapigami figures with LEDs, while Lindsay worked on sticky note topographical maps, sticky note quilling, paper puppets, paper inflatables, plastic inflatables, a slingshot with a handle-launcher, and more! After all these projects, we thought, “How do we make what we discovered and played with into a Makerspace program?” Cup launchers and paper inflatables were the 2 projects that fit together, since Kenny kept aiming at Lindsay’s inflatables and knocking them down. The ah-ha moment came when we turned it into a Caine’s Arcade-inspired shooting gallery after finding the cardboard fort kits. They were perfect to make tables to hold the knock over stands for the inflatables to stand on.

Innovation Inflated

The paper inflatables idea came from an interview Lindsay had when she had to lead a project. Originally the project was made of plastic, but it was very difficult to see holes, plastic was not as colorful, more tedious when it came to taping, and hard to work with since the static of plastic makes it stick together. Paper solved all those problems above and was an interesting solution to make the target permanently inflated so there was no need for actual air or a fan to blow them up. Plus, they were whimsical and gave guests more ability to decorate!

Maker Learning

Facilitation was a difficult for teaching how to make the slingshots and getting people to create the paper targets. At first people were only interested in making the example slingshot design rather than develop their own. However, once they made one slingshot, then they began to take the design into their own hands once they realized there were multiple ways to launch a ping-pong ball. There was 1 guest who just used a plastic spoon like a catapult! Some guests did not want to make the paper inflatable and focused entirely on slingshot building, but if they had a sibling or a parent that wanted to, sometimes the projects would be split between everyone. We had multiple families share projects between them even! One family created a few slingshot designs and shared theirs with another family who let them use their paper inflatables.

Maker Independence

At the beginning of the summer, we needed to collaborate closely with Bridget and Jessica to figure out what we wanted to do. There is a lot of ideation and problem solving that goes into the planning stages of a program, but the development of our final Makerspace program shows that we have a good handle on figuring out those problems. No outside resources were used for Wild, Wild Tech—it was the result of creative tinkering in The Tech Studio.

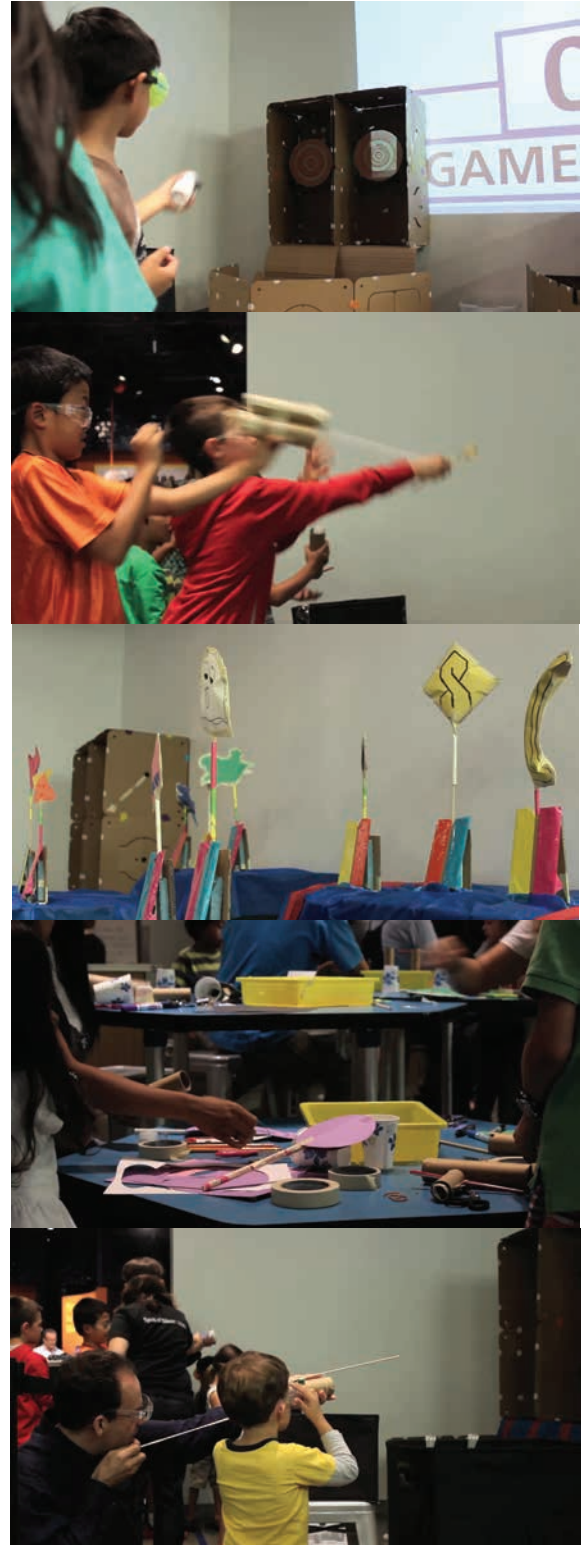

Resources

Fort Building Kit Bildopolis:
<http://www.bildopolis.com/>

Caine's Arcade, for cardboard arcade inspiration:
<http://cainesarcade.com/>

Our own Maker imagination



Our Resources

Guides and Tutorials
developed by us!

Kenny's Guide to Making Things Make Sounds



Goal

To add sound effects to something out in the real world. As an example, for our Patriotic Projectiles Makerspace at The Tech Museum of Innovation we added fireworks sound effects to our stomp rocket launchers. We placed a force sensitive resistor beneath a stomp rocket pad, so that every time guests stomped and launched their rocket, fireworks sounds were triggered.

Ingredients

Hardware

Arduino

Wires

Force Sensitive Resistor (or a different analog input if you would like)

One 1k Resistor

Soldering Iron

Solder

Software

Arduino IDE

Processing IDE



Resources

Getting Started with Arduino:

<http://arduino.cc/en/Guide/HomePage>

Getting Started with Processing:

<http://processing.org/tutorials/gettingstarted/>

Adafruit FSR Tutorial:

<http://learn.adafruit.com/force-sensitive-resistor-fsr/overview>

Step 1: Wire Up Arduino

1. Connect the 5v and Ground on the Arduino to the power and ground on the Breadboard.
2. Bridge your Power and Ground on the breadboard so both sides of the breadboard has power.
3. Place your FSR into the breadboard like the picture above.
** Optional: Depending on your motives, you may want to solder wires onto each of the FSR legs so that you can your FSR and put it on, under, or inside of things.
4. Connect the left leg of the FSR to Ground with your 1K Resistor.
5. Connect the right leg of the FSR to Power with a wire.
6. Connect the Analog 0 pin on your Arduino to the left leg of your FSR

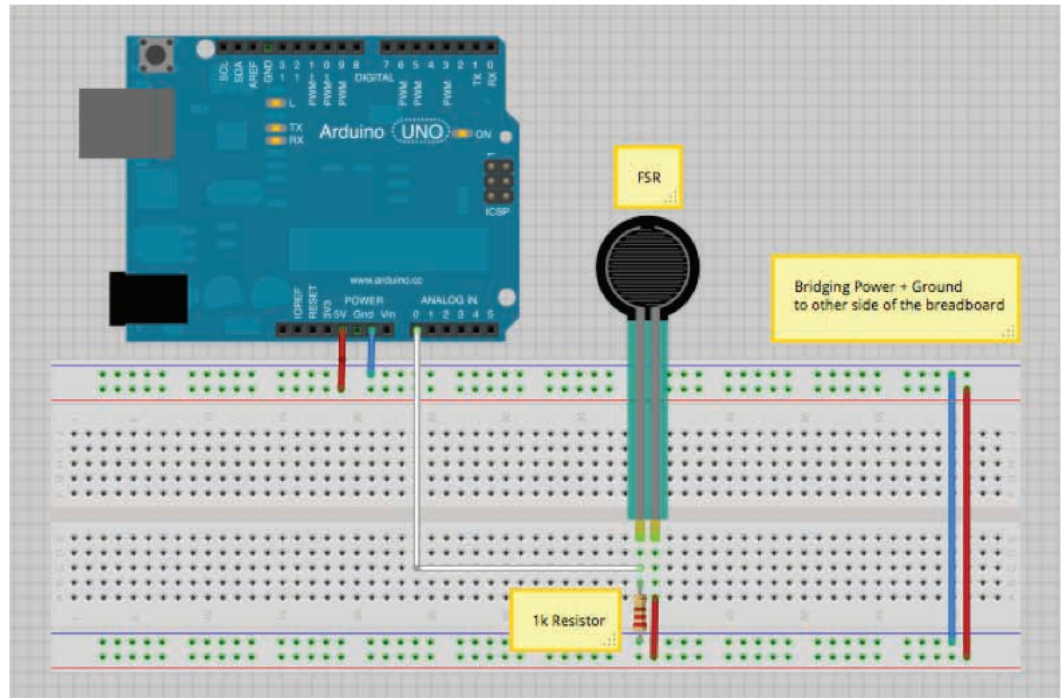

Step 2: Connecting your Arduino to the Computer and Processing

1. Download Arduino (<http://arduino.cc/en/main/software>) and Processing (<https://processing.org/download>) if you have not done so yet.
2. Plug your Arduino in via USB
3. Open up Arduino Software
4. Go to File > Examples > Firmata > Standard Firmata

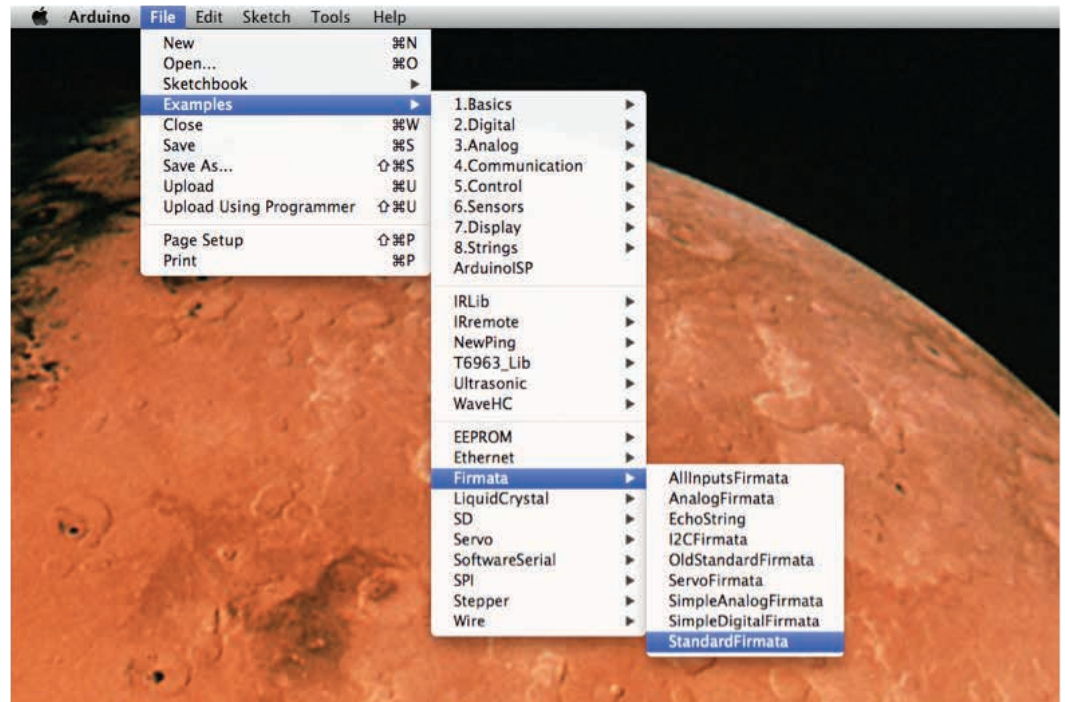

5. Upload Standard Firmata Code

By uploading the Standard Firmata code we are setting up a communication line between our Arduino and the Processing Software

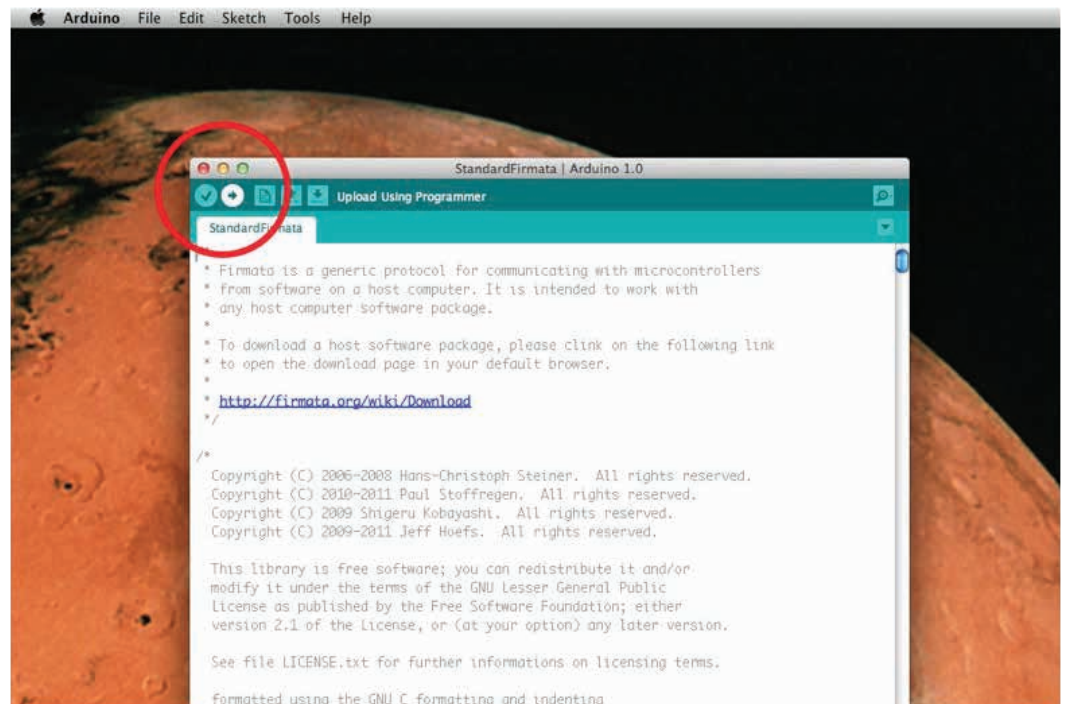

6. Download our Processing Code titled SoundFXTheTech.zip from here: <https://github.com/kguglielmino/TheTech>

7. Unzip our Example Code

8. Notice that there is the .PDE file that contains our code and then there is a data folder. The data folder is where we place the sound effects we want to use in our program. So put the sound file you want to use in here.

9. Open the .PDE file with Processing.

Step 3: Adjusting the Program in Processing to Trigger your own Sound

1. Make sure that your sound file is in the data folder of your sketch as referenced previously.
2. Change the AudioSample name in your code.

```
import processing.serial.*; // opening up communication between arduino & processing
import cc.arduino.*; // opening up communication between arduino & processing
Arduino arduino; //creates arduino object

import ddf.minim.*; // importing sound library
Minim minim; // creates minim object

/* If you are changing this to your own sound effect, change the name below
   For example you could change it to be: AudioSample yourfile; */
AudioSample fireworks1; // the name we give to our audio file.

int sensorA0= 0; // the sensor we're using on the arduino
int readA0; // variable that reads the information from the arduino
```

3. Change the AudioSample name and file name in the void setup().

```
/* This is where we load our sound sample, you will need to change this line of code to
   match the sound effects filename you are loading and the AudioSample name above
   ie: yourfile = minim.loadSample("youraudiofile.mp3,320)
   Note: Processing is case sensitive, so be precise*/
   fireworks1 = minim.loadSample("FW1.mp3", 320); //(filename, Bitrate)
   fireworks1.setVolume(3.0); //raising the volume levels
   ...
```

4. Change the AudioSample name in the if statement in your void draw.

```
/* This is where the action happens.
   If readA0 gets a force reading that is greater than 50, it triggers our sound.
   You may need to readjust the greater than number(50) depending on the readings
   you are receiving at any given moment, or if you want to change the sensitivity.*/

if (readA0 > 50) {
  //timer goes here to prevent the sounds from being triggered rapidly
  if (passedTime > totalTime) {
    //...if 7 seconds has passed since the last sound was triggered
    println("Fireworks!");
    /* you will need to change the AudioSample name below.
    ie: yourfile.trigger(); */
    fireworks1.trigger(); // this is where the sound file gets triggered
    savedTime = millis(); // Save the current time to restart the timer
  } //timer
} // if statement
```

5. Click the Run button in the top left and it should work!

Step 4: Get Creative

Now try things out! Try extending your FSR and putting it under, ontop of, or inside things. Do you want your floormat to say something to you every time you step on it? Do you want your tape holder to scream every time you pick it up? Do you want to bring your stuffed animal to life? Make something peculiar. Make something amazing. Make something funny. Life is your oyster shell. Crack it yo.

'**~The Notorious DIY~**'

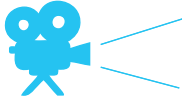

Creative Tech in Action!

Week

3

Patriotic Projectiles

<http://www.thetech.org/about-us/tech--blog/makerspace--tech-patriotic-projectiles>



Week

5

Paper Engineering

<http://www.thetech.org/about-us/tech--blog/makerspace--tech--paper-engineering>

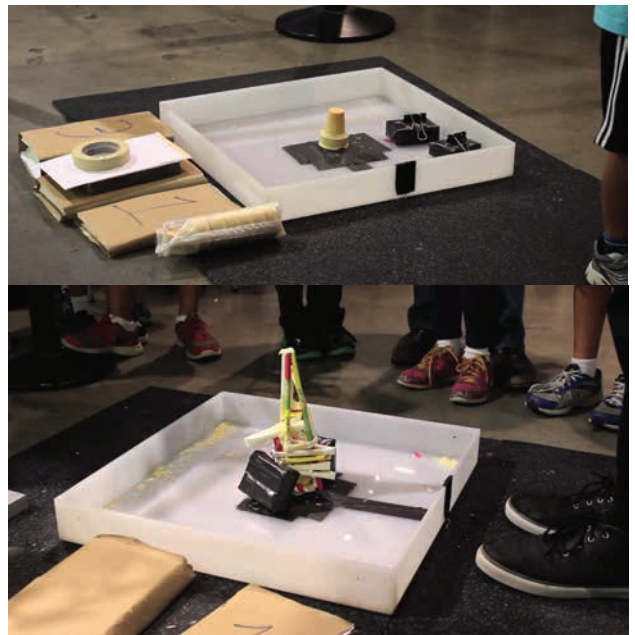

Maker Thanks!

We want to thank The Tech Museum of Innovation and its staff who helped us develop Makerspace! Special thanks goes to Bridget Rigby and Jessica Henricks who helped develop ideas for programs, helped with planning, supported us on the museum floor, and taught us how to facilitate Maker activities. Makerspace @ The Tech wouldn't have been a success if it weren't for their expertise and moral support. We would also like to extend our thanks to the Engineering, Exhibits, Museum Gallery Staff, and Marketing teams for their help throughout the summer.

We thank the museum volunteers, especially the ones who stuck by us every week, even when there were technical difficulties, when we were overwhelmed with large groups of guests, and when we had facilitation challenges. Your patience, sense of commitment, and positivity helped us create a wonderful experience for guests and we couldn't have made so many smiles without you.

We would like to thank the Makerspace regulars, the guests who kept coming back to learn, play, and make with us week after week, whether there was a new program or they just really loved the same one! It was our greatest reward to see that we were providing fun activities for you to keep visiting us. Makerspace was able to continue because of your constant support.

And finally, a big thank you to Steve Davee and Lisa Regalla for introducing us to the Maker Education Initiative and Maker Corps and giving both of us the a chance to experience something greater than we ever imagined. The training, unlimited amount of resources, moral support, connections... if it weren't for you two, we would have never have met the amazing people we did at The Tech Museum of Innovation this past summer.

Thank you, everyone.

Sincerely,
~ Maker Lindsay & Maker Kenny

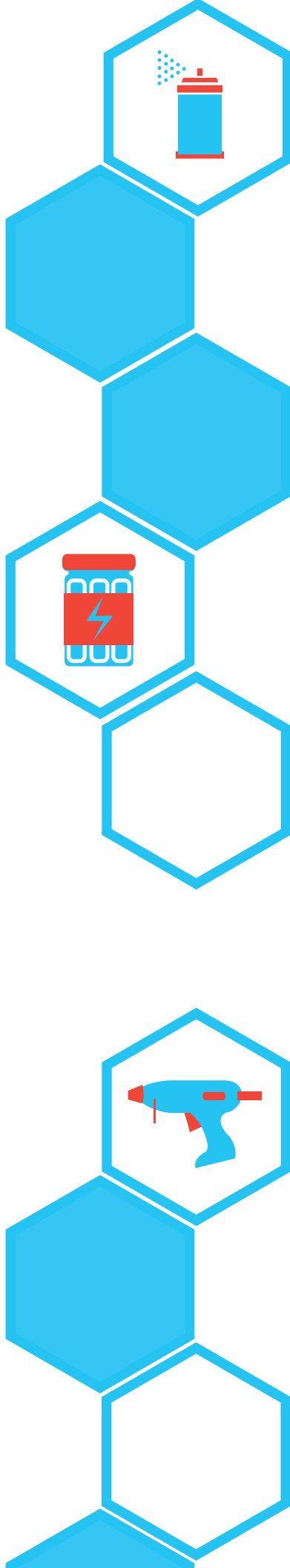

Reflections



Kenny and Lindsay both posted reflections on their Makerspace summer. You can check out their personal reflections on the Tech's Blog:



Maker Kenny's Reflections:

<http://www.thetech.org/about-us/tech-blog/makerspace-tech-maker-kennys-reflections>



Maker Lindsay's Reflections:

<http://www.thetech.org/about-us/tech-blog/makerspace-tech-maker-lindsays-reflections>

Connect

... and share recipes!

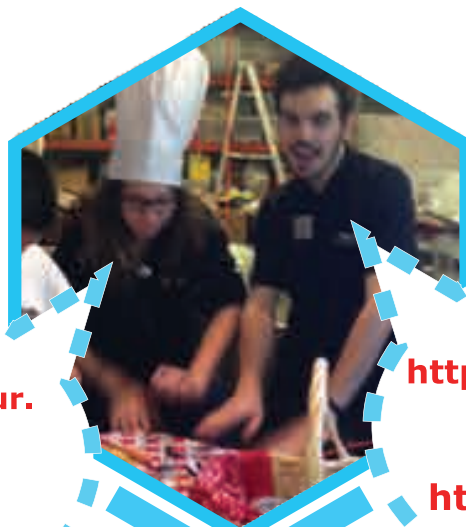

<http://lindsaybalfour.daportfolio.com/>



<https://twitter.com/MaKeyLindsay>



<http://kennethgug.com/>



<https://twitter.com/MakerKenny>

100% Creative Confidence

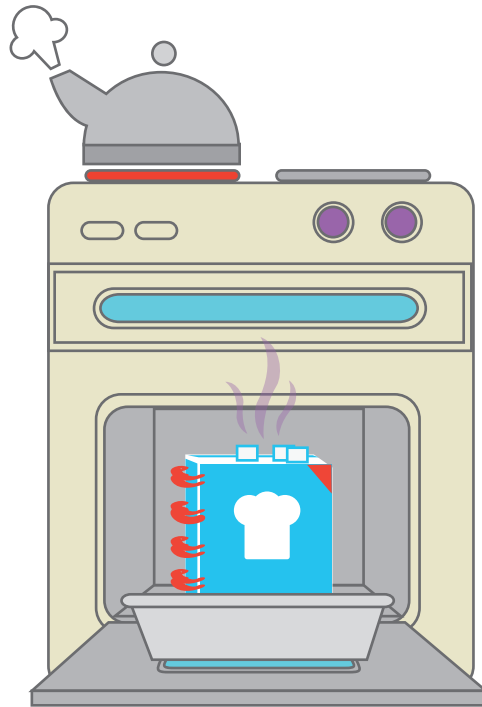

*To Kenneth Guglielmino, the best Maker Baker partner in crime.
To Bridget Rigby, for being the positive role model I aspire to be.
To Jessica Henricks, for guiding us through every innovative program.*

Inspiring the Innovator in Everyone.

Maker Corps Summer 2013

Makerspace @ The Tech Cookbook Beta Sampler is licensed under a Creative Commons Attribution-NonCommercial 4.0 International License.