



Chengdu Ebyte Electronic Technology Co.,Ltd

Wireless Modem

User Manual



NT1-B User Manual

Serial ⇌ Ethernet

Serial Server

All rights to interpret and modify this manual belong to
Chengdu Ebyte Electronic Technology Co., Ltd.

CONTENTS

Disclaimer	1
1 Product Overview	2
1.1 Brief Introduction	2
1.2 Feature	2
2 Quick Start	3
2.1 Preparation for use	3
2.2 Device wiring	3
2.3 Software Settings	4
2.3.1 Network test environment	4
2.3.2 Default parameters	5
2.3.3 Data transmission test	5
3 Product Overview	7
3.1 Technical parameters	7
3.2 Interface and Indicator Description	8
3.3 Dimensions	10
4 Functional Introduction	11
4.1 Serial port parameters	11
4.2 Introduction to basic functions	11
4.2.1 Web page configuration	11
4.2.2 Subnet mask/IP address	13
4.2.3 Domain Name Resolution (DNS)	14
4.2.4 Restore factory settings	14
4.3 Socket function	14
4.3.1 TCP server mode	14
4.3.2 TCP Client Mode	14
4.3.3 UDP Server Mode	14
4.3.4 UDP Client Mode	15
4.3.5 HTTP Client Mode	15
4.3.6 MQTT Client mode	17
4.4 Advanced Features	20
4.4.1 Random native port	20
4.4.2 Heartbeat Packet Function	20
4.4.3 Registration package function	21
4.4.4 Short connection function	21
4.4.5 Timeout restart function	21
4.4.6 Cache cleaning function	22
4.4.7 Network disconnection and reconnection	22
4.4.8 Remote upgrade	22
4.5 Modbus Gateway	23
4.5.1 Modbus RTU and Modbus TCP protocol conversion	23
4.5.2 Simple Protocol Conversion Mode	24
4.5.3 Multi-host mode	24

4.5.4 Storage Gateway	25
4.5.5 Configurable Gateway	25
4.5.6 Automatic upload	26
5 Configuration Mode	28
5.1 Web Settings	28
5.2 Configuration tool software settings	28
5.3 AT command configuration	28
Revision history	29
About us	29

Disclaimer

EBYTE reserves all rights to this document and the information contained herein. Products, names, logos and designs described herein may in whole or in part be subject to intellectual property rights. Reproduction, use, modification or disclosure to third parties of this document or any part thereof without the express permission of EBYTE is strictly prohibited.

The information contained herein is provided “as is” and EBYTE assumes no liability for the use of the information. No warranty, either express or implied, is given, including but not limited, with respect to the accuracy, correctness, reliability and fitness for a particular purpose of the information. This document may be revised by EBYTE at any time. For most recent documents, visit www.ebyte.com.

Note:

The contents of this manual are subject to change due to product version upgrades or other reasons. Chengdu Ebyte Electronic Technology Co.,Ltd. reserves the right to make changes to the contents of this manual without notice or suggestion. This manual serves only as a user guide and Chengdu Ebyte Electronic Technology Co.,Ltd. endeavours to provide accurate information in this manual, but Chengdu Billionaire Electronics Co., Ltd. does not ensure that the contents are completely error-free and that all statements, information and suggestions in this manual do not constitute any express or implied warranty.

1 Product Overview

1.1 Brief Introduction

NT1-B is a module (also known as "super network port") that realizes serial data ↔ Ethernet data transmission, and is packaged with 2.54mm pitch pins;

Support multiple Modbus gateways and IoT gateways (MQTT and HTTP);

It can meet the networking functions of various TTL level serial devices and MCUs;







1.2 Feature

- RJ45 adaptive 10/100M Ethernet interface;
- Support multiple working modes (TCP Server, TCP Client, UDP Server, UDP Client, HTTPC, MQTTC);
- Support three configuration methods: configuration tool, web page and AT command;
- Server mode supports multiple socket connections;
- Support multiple baud rates;
- Support multiple check (None, Odd, Even, Mark, Space);
- Support multiple serial flow control configurations (NONE,CTS/RTS, DSR/DTR, XON/XOFF);
- Support DHCP function;
- Support DNS (domain name resolution), and custom domain name resolution server;
- Support multiple Modbus gateways (simple protocol conversion, multi-host mode, storage gateway, configurable gateway, etc.);
- Supports quick access to Alibaba Cloud, Baidu Cloud, OneNET, Huawei Cloud, and standard MQTT servers of version 3.1;
- Support HTTP protocol (GET/POST request)
- Support virtual serial port;
- Support timeout restart function, time can be customized;
- Support short connection function, short connection interval time customization;
- Support heartbeat package and registration package function;
- Support serial port cache cleaning function;
- Support access to external network and local area network;
- Support hardware reset to factory settings;
- Support online upgrade function.

2 Quick Start

2.1 Preparation for use

Before using the serial server (hereinafter referred to as "device"), you need to prepare network cables, computers, USB-to-serial converters and other related accessories. details as follows:

		
<p>NT1-B</p>	<p>Cable</p>	<p>Computer</p>
		
<p>USB to TLL(E15-USB-T2)</p>		<p>Dupont Line</p>

2.2 Device wiring

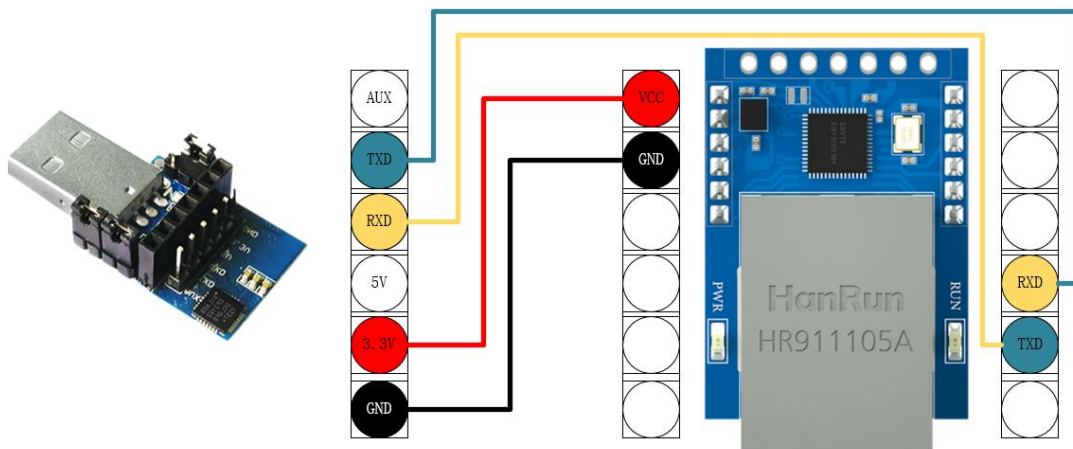

Step 1: Connect the USB to serial port to provide power for the device and serial port data conversion, the TXD of the conversion tool is connected to the RXD of the device, the RXD of the conversion tool is connected to

the TXD of the device, and the GND is connected correspondingly (the GND connection cannot be omitted);

Step 2: Connect the RJ45, the device is in the network cable detection mode when the network cable is not connected, and does not enter the working state;

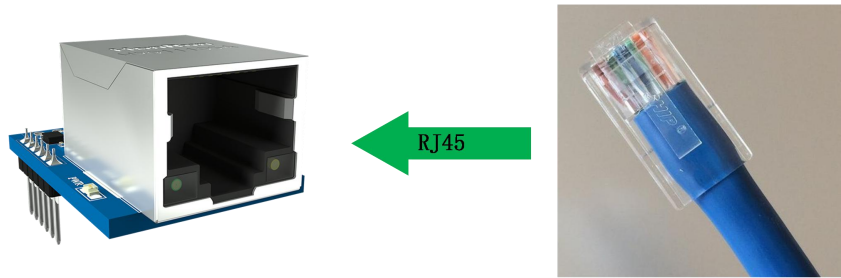

2.3 Software Settings

2.3.1 Network test environment

Avoid server search failures and inability to open web page configuration and other related problems in the actual application process. Check the computer settings first .

- (1) Turn off the firewall and anti-virus software of the computer;
- (2) Configure the network card connected to the device;
- (3) In this case, the PC is directly connected to the computer, and the static IP of the computer needs to be configured. The static IP of the computer, refer to the PC direct connection configuration) or the router needs to ensure that the device and the PC are on the same network end (for example: 192.168.3.xxx);
- (4) Here, configure the static IP of the PC as 192.168.3.3 (the factory default destination IP of the serial port server), configure the subnet mask as 255.255.255.0, and configure the default gateway as 192.168.3.1;

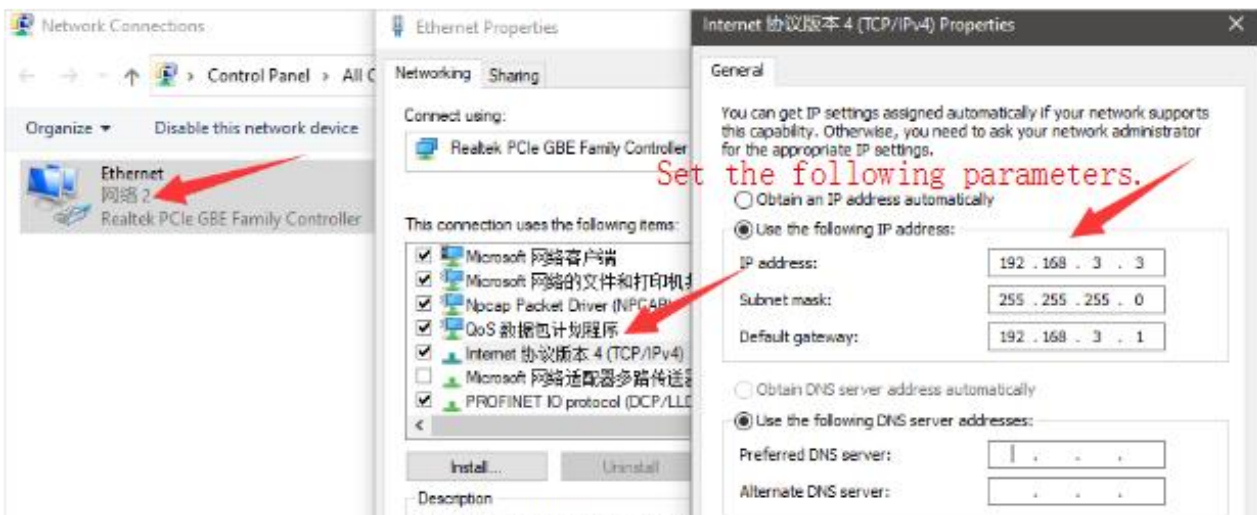

2.3.2 Default parameters

Item	default parameters
IP Address	192.168.3.7
Default local port	8887
subnet mask	255.255.255.0
default gateway	192.168.3.1
Default working mode	TCP Server
Default destination IP	192.168.3.3
Default destination port	8888
Serial port baud rate	115200
Serial port parameters	None / 8 / 1

2.3.3 Data transmission test

After the above operation steps, follow the factory default parameters of the device and perform the following operations to realize the transparent transmission test of data.

The operation steps are as follows:

(1) Open the test TCP/IP debugging assistant software.

(2) Select the TCP client mode (TCP Client) in the "Network Setting Area", corresponding to the remote host address (the default local IP of the device: 192.168.3.7). The remote host port corresponds to the factory port 8887 of the device, click Connect.

(3) Wait for the computer to connect to the serial server. After the connection is completed, the LINK light of the serial server is always on.

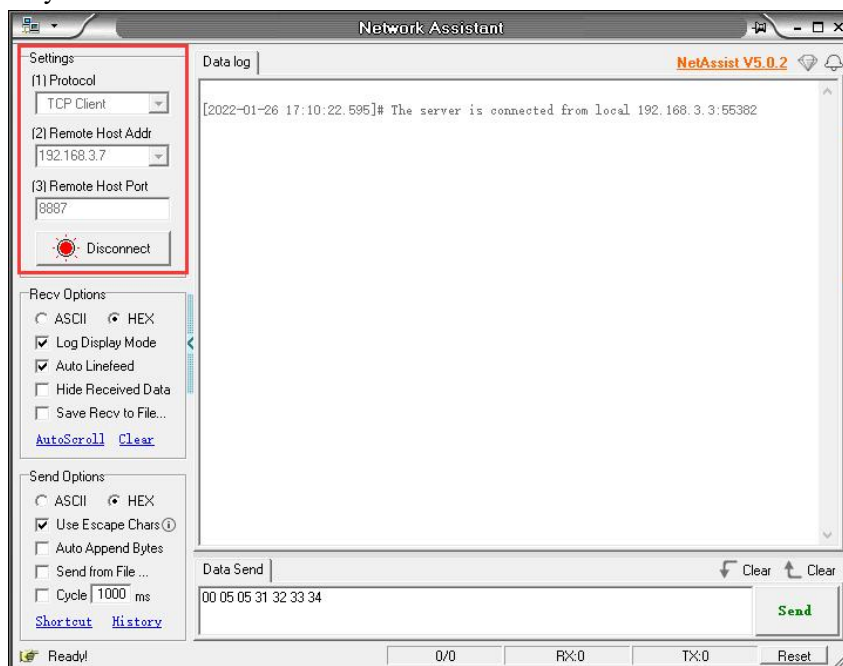

(4) Open the serial port assistant, select the corresponding serial port, set the baud rate to 115200, set other serial port parameters to None/8/1, and click "Open Serial Port".

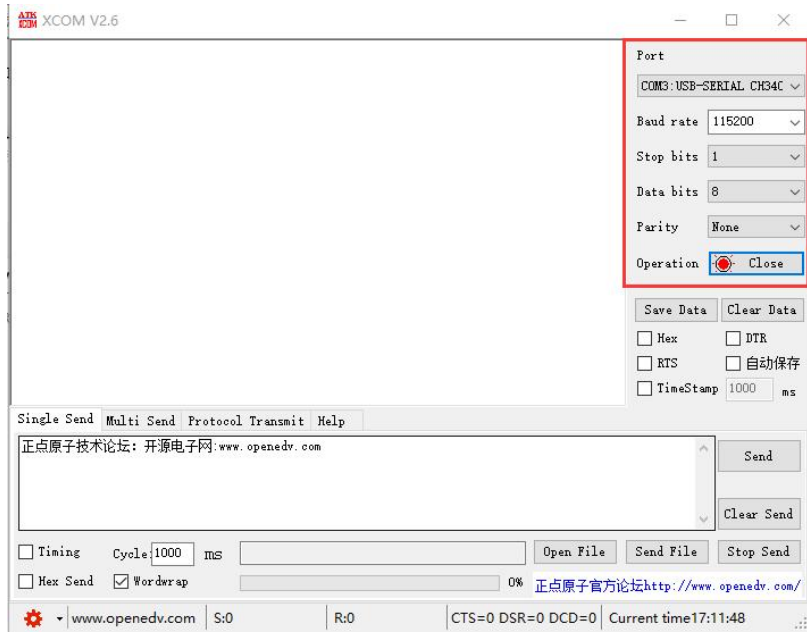

Data transmission test, the serial port assistant (serial port side) sends the test data, and the network debugging assistant (network side) receives the test data. The network debugging assistant (network side) sends test data, and the serial port assistant (serial port) receives test data. Realize duplex communication (that is, two-way data sending and receiving from local to network).

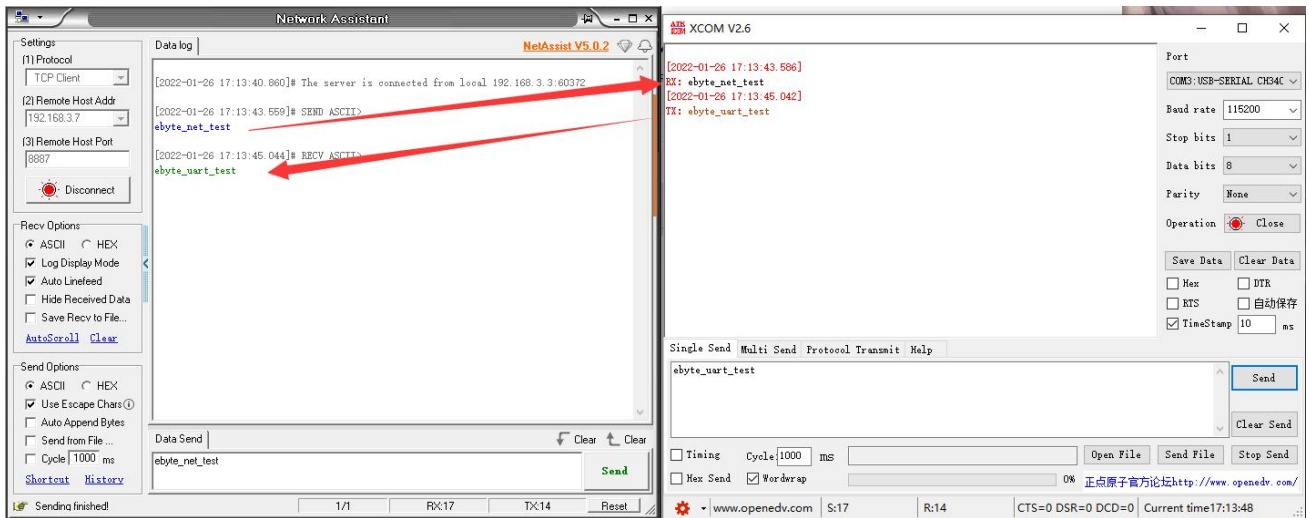

3 Product Overview

3.1 Technical parameters

Item	Instruction
Operating Voltage	3.0 ~ 5.5V (DC)
current drain	9mA @ 5V
Interface	TTL(2.54 mm Pin) Ethernet port (RJ45)
Work Mode	TCP Server、TCP Client、UDP Server、UDP Client、HTTP Client、MQTT Client(default TCP Server)
Socket connection	Support 6-way client connection (TCP server mode)
Network protocol	IPv4、TCP/UDP、HTTP、MQTT
How to get IP	DHCP、Static IP (default static IP)
DNS	Support
DNS server	Customizable (default 114.114.114.114)
Configuration method	Web pages, configuration tools, AT commands
IP address	Customizable (default 192.168.3.7)
local port	Customizable (default 8887)
subnet mask	Customizable (default 255.255.255.0)
gateway	Customizable (default 192.168.3.1)
target IP	Customizable (default 192.168.3.3)
destination port	Customizable (default 8888)
Serial port cache	1024Byte
Packaging mechanism	512 Byte
Serial port baud rate	1200 ~ 230400 bps (default 115200)
data bits	5、6、7、8 (default 8)
stop bit	1、2 (default 1)
Check Digit	None、Odd、Even、Mark、Space (default None)
Flow Control	NONE、CTS/RTS、DSR/DTR、XON/XOFF(default None)
Product Size	35mm * 22mm * 21mm (length*width*height)
product weight	8.8g ± 1g
Working temperature and humidity	-40 ~ +85°C、5% ~ 95%RH (no condensation)
Storage temperature and humidity	-40 ~ +105°C、5% ~ 95%RH (no condensation)

3.2 Interface and Indicator Description

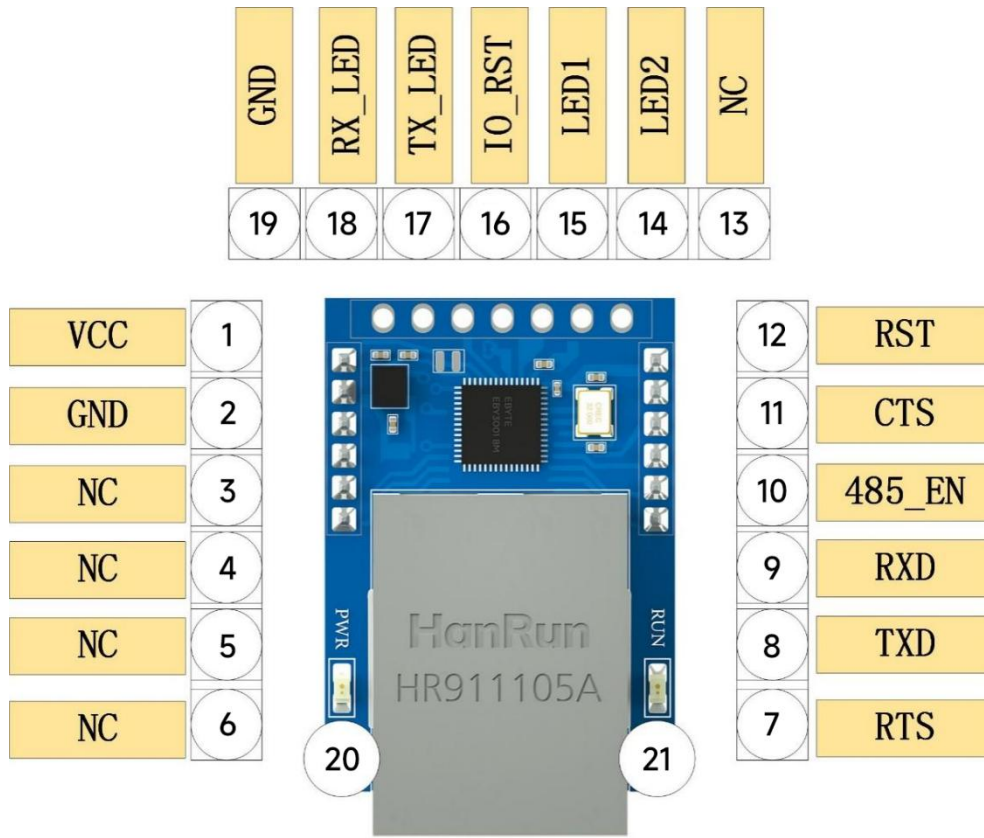

No.	Pins	Function
1	VCC	Power positive input, support 3~5.5V input;
2	GND	Common ground terminal, power supply negative input;
3-6	NC	Suspended by default;
7	RTS	MODEM output signal of serial data, request sending;
8	TXD	Serial port sends data, TTL level communication voltage only supports 3.3V, if connected to 5V level conversion is required;
9	RXD	The serial port receives data, the TTL level communication voltage only supports 3.3V, if connected to 5V, level translation is required;
10	485_EN	RS485 enable the control pin, the serial port sends data when it is set high, and the normal is low;
11	CTS	MODEM input signal for serial data, clear send;
12	RST	External reset input, low level more than 100 nanoseconds active, internal weak pull-up;
13	NC	Suspended by default;
14	LED2	Network port link indicator output, Output a 4Hz square wave within 3 seconds of power-on

		The default output is high, the TCP protocol outputs the low level after the connection is successful, and the UDP protocol outputs the low level by default;
15	LED1	Run the pin Output 4Hz square wave within 3 seconds of power-on Network cable not connected: output 5Hz square wave Network cable connected: but not networked: output 1Hz square wave Network connection successful: output 0.33Hz square wave When the serial port has data transmission and reception, the output is 60 milliseconds pulse low
16	IO_RST	Restore factory pin, internal weak pull-up, can be connected to the reset button, low level lasts for about 5 seconds effective;
17	TX_LED	Serial port send indicator; Output 4Hz square wave within 3S of power-on After 3 seconds, the output low level of the network cable is not detected, and the output high level is output when the network cable is detected. After the network cable detection is completed, the output is low when there is data output, and the output period is 80 milliseconds when there is continuous data, and the square wave signal is output with a low level of 20 milliseconds;
18	RX_LED	Output a 4Hz square wave within 3 seconds of power-on After 3 seconds, the output low level of the network cable is not detected, and the output high level is output when the network cable is detected. After the network cable detection is completed, the output is low when there is data input, and the output period is 80 milliseconds when there is continuous data, and the square wave signal is output with a low level of 20 milliseconds;
19	GND	Common ground terminal, power supply negative input;
20	PWR	Power access indicator;
21	RUN	Output 4Hz square wave within 3 seconds of power-on Network cable not connected: output 5Hz square wave Network cable connected: but not networked: output 1Hz square wave Network connection successful: output 0.33Hz square wave When the serial port has data transmission and reception, the output is 60 milliseconds pulse low

3.3 Dimensions

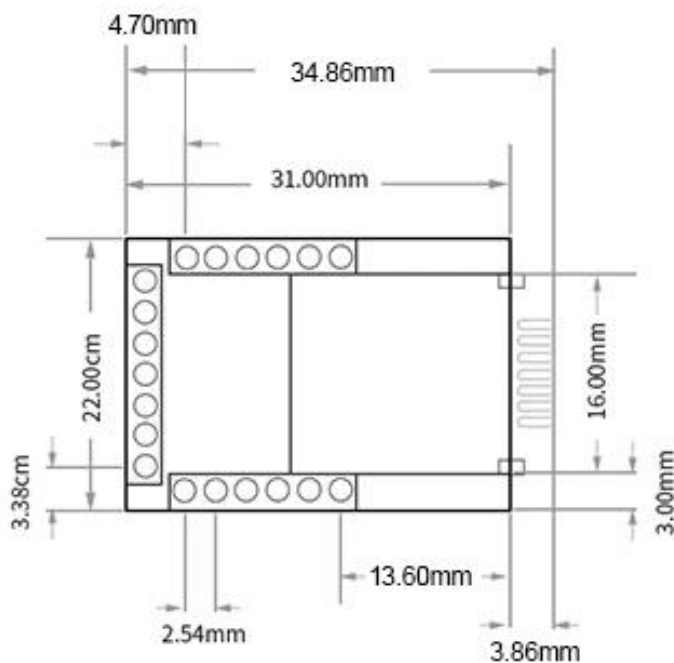

4 Functional Introduction

4.1 Serial port parameters

The basic parameters of the serial port include: baud rate, data bits, stop bits, and parity bits.

Baud rate: serial communication rate, configurable 1200, 2400, 4800, 9600, 14400, 19200, 38400, 57600, 115200, 230400bps.

Data Bits: The length of the data bits, the range is 5, 6, 7, 8.

Stop bit: range 1, 2 can be set.

Check digit: The check digit of data communication, supports five check modes: None, Odd, Even, Mark, Space.

Flow Control: NONE、CTS/RTS、DSR/DTR、XON/XOFF

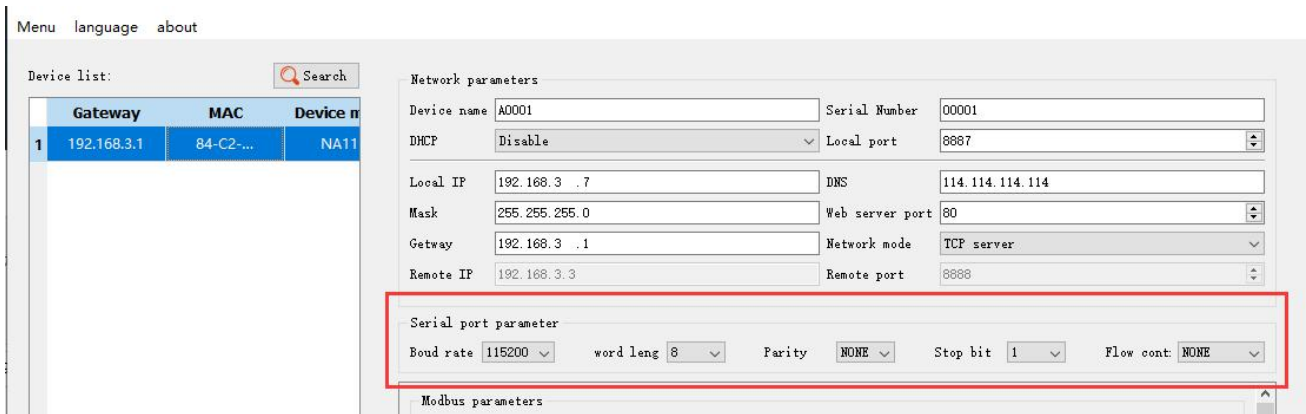

4.2 Introduction to basic functions

4.2.1 Web page configuration

The device has a built-in web server, which is convenient for users to set and query parameters through web pages.

The port of the web server can be customized (2-65535), default: 80

Operation method (Microsoft Edge version 94.0.992.50 is an example, it is recommended to use Google kernel browser, IE kernel browser is not supported):

Step 1: Open the browser, enter the IP address of the device in the address bar, for example 192.168.3.7 (the IP address and the computer need to keep the same network segment), if you forget the IP of the machine, you can query it through AT commands and configuration software

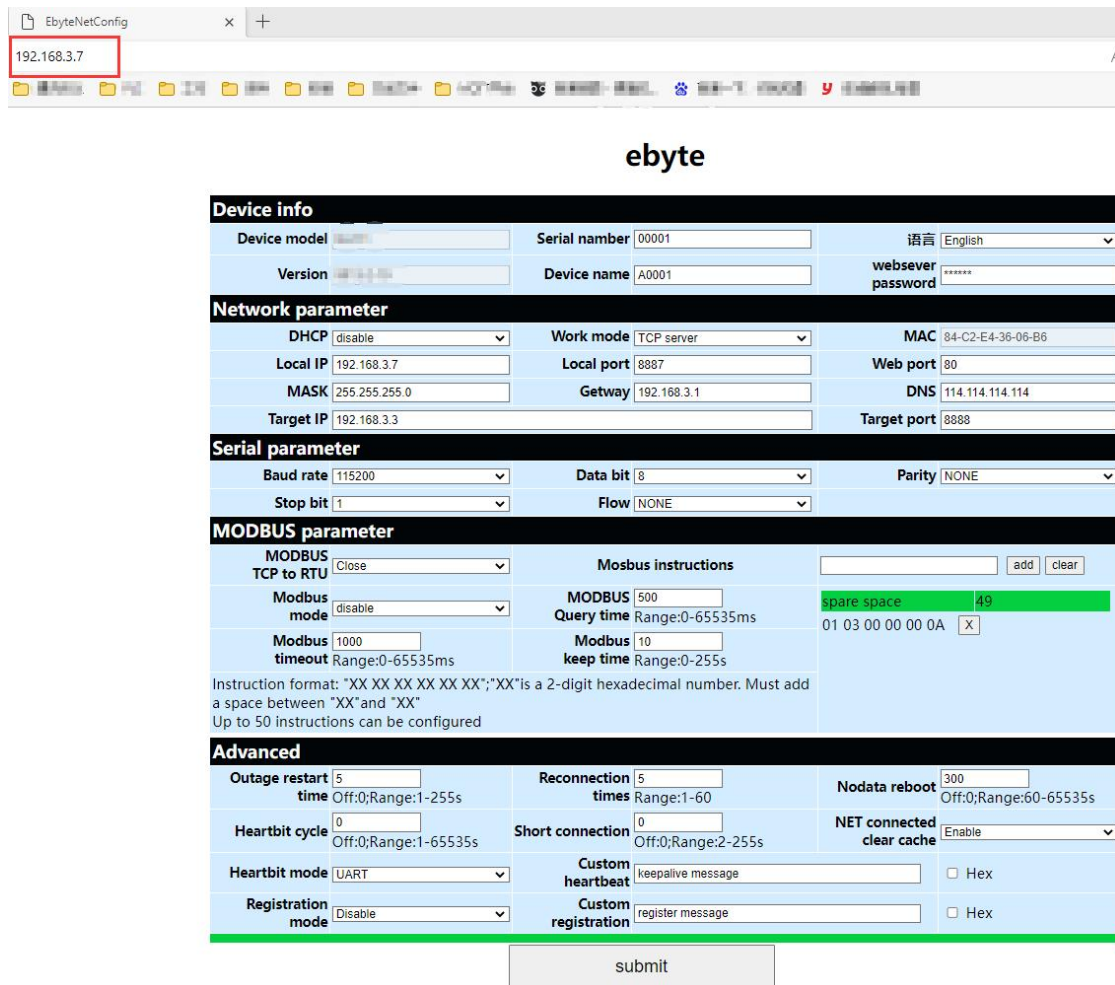

Step 2: The webpage pops up the main interface, and you can query and set relevant parameters;

Step 3: Click Submit to save the configuration parameters after entering the correct key. The factory default key is: 123456;



Step 4: The progress bar indicates the configuration progress. Do not refresh the web page again after the configuration is completed (refresh the web page to enter the configuration mode again, you can restart the device or submit it again to enter the communication mode);

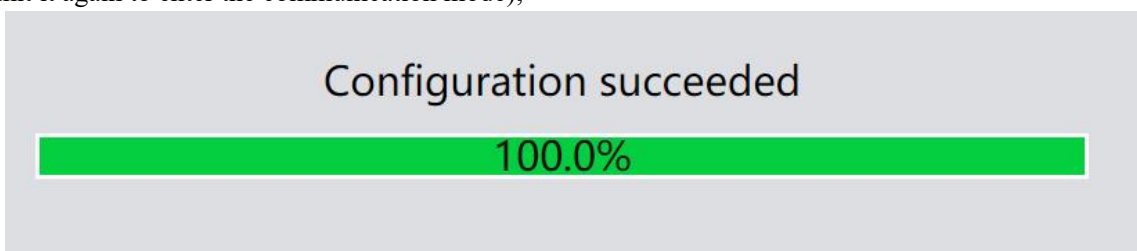

It can also be opened through the Open Web Configuration button of the configuration software.

[Note] If the port number is modified, the port number should be added to the address input field. For example, if you modify the web page access port to 8080, you need to enter 192.168.3.7:8080 in the address bar to connect to the web page configuration.

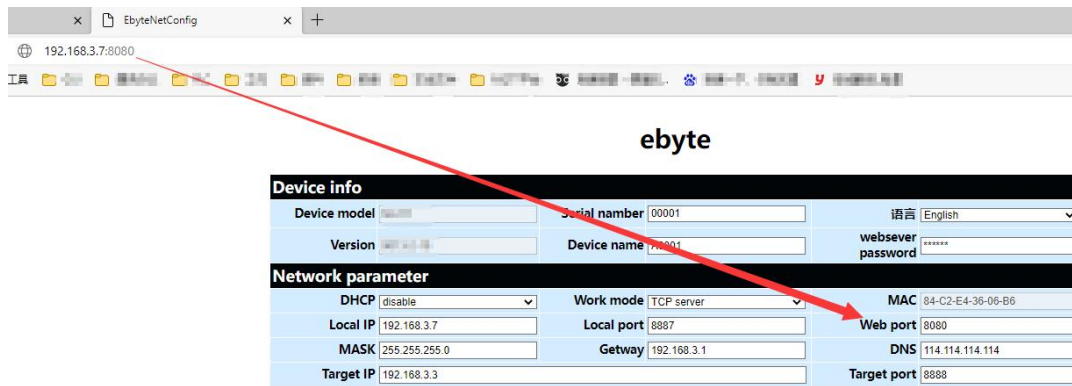

4.2.2 Subnet mask/IP address

The IP address is the identification of the module in the local area network and is unique in the local area network. Therefore, it cannot be duplicated with other devices on the same local area network. There are two ways to obtain the IP address of the module, static IP and DHCP.

(1) Static IP: Static IP needs to be set manually by the user. In the process of setting, pay attention to writing IP, subnet mask and gateway at the same time. Static IP is suitable for scenarios where IP and device statistics are required and one-to-one correspondence is required.

Advantages: Access to devices that cannot be assigned IP addresses can be searched through the broadcast mode of the entire network segment, which is convenient for unified management;

Disadvantages: Different network segments in different LANs, resulting in normal TCP/UDP communication.

(2) Dynamic DHCP: The main function of DHCP is to dynamically obtain the IP address, gateway address, DNS server address and other information from the gateway host, thereby eliminating the tedious steps of setting the IP address. It is suitable for scenarios where there is no requirement for IP, and there is no mandatory one-to-one correspondence between IP and modules.

Advantages: devices with DHCP Server such as access routers can communicate directly, reducing the trouble of setting IP address gateway and subnet mask.

Disadvantage: Connecting to a network without DHCP Server, such as direct connection with a computer, the module will not work properly. The subnet mask is mainly used to determine the network number and host number of the IP address, to indicate the number of subnets, and to determine whether the module is in the subnet. The subnet mask must be set. Our commonly used class C subnet mask: 255.255.255.0, the network number is the first 24 bits, the host number is the last 8 bits, the number of subnets is 255, and the module IP is in the range of 255 within this subnet, the module IP is considered to be in this subnet. Gateway refers to the network number of the network where the current IP address of the module is located. If a device such as a router is connected to the external network, the gateway is the router

4.2.3 Domain Name Resolution (DNS)

Domain name resolution translates domain names into network-recognized IP addresses through Domain Name Resolution (DNS) servers. The domain name resolution (DNS) server address of the serial port server supports user definition, and can realize domain name resolution through a custom domain name resolution server in the event of an abnormal domain name server. The device will report the resolution to the custom domain name resolution (DNS) server during domain name resolution. Request, return the device connection parameters (usually the IP address) after the parsing is completed.

In DHCP mode, the domain name resolution (DNS) server address is automatically obtained (synchronized with the router's domain name resolution address) and cannot be modified.

In static IP mode, the factory default address of the Domain Name Resolution (DNS) server is 114.114.114.114.

4.2.4 Restore factory settings

Press and hold the Reload pin of the device until the LED indicator lights up to release the key.

4.3 Socket function

4.3.1 TCP server mode

TCP Server is the TCP server. In TCP Server mode, the device listens to the local port, accepts the client's connection request and establishes a connection for data communication. When the Modbus gateway function is turned off, the device sends the data received by the serial port to all client devices that establish connections with the device, and supports connecting up to 6 clients. After the Modbus gateway function is enabled, the non-Modbus data will be cleared and not forwarded.

Typically used for communication with TCP clients within a local area network.

4.3.2 TCP Client Mode

TCP Client is the TCP client. When the device is working, it will actively initiate a connection request to the server and establish a connection to realize the interaction between serial port data and server data.

To use the client, you need to configure the target IP address/domain name and target port accurately.

4.3.3 UDP Server Mode

UDP Server means that the device does not verify the IP address of the data source when communicating with the UDP protocol. After receiving a UDP data packet, it saves the source IP address and source port of the data packet, and sets it as the destination IP and port, so The data sent by the device only sends data packets to the source IP address and port where the device received data last time .

This mode is usually used in scenarios where multiple network devices communicate with this device, and the frequency is high, and the TCP Server cannot meet the conditions.

Using UDP Server requires the remote UDP device to send data first, otherwise the data cannot be sent normally.

[Note] In UDP mode, the data sent by the network to the device should be less than 512Bit per packet, otherwise it will cause data loss

4.3.4 UDP Client Mode

UDP Client is a connectionless transmission protocol that provides transaction-oriented simple and unreliable information transmission services. There is no connection establishment and disconnection, and data can be sent to the other party only by configuring the destination IP and destination port. It is usually used in data transmission scenarios where there is no requirement for the packet loss rate, the data packets are small and the transmission frequency is fast, and the data is to be transmitted to the specified IP.

In UDP Client mode, the device will only communicate with the configured (target IP and target port) remote UDP devices.

In this mode, the target address is set to 255.255.255.255, and the sent data will be broadcast on the entire network segment, but the transceiver device needs to ensure that the ports are consistent, and the device can also receive broadcast data.

4.3.5 HTTP Client Mode

This mode can realize the function of HTTP grouping. It provides two modes: GET and POST. Customers can configure URL, Header and other parameters by themselves, and the device (serial port server) will send packets to realize fast communication between the serial port device and the HTTP server. In HTTP client mode, it is recommended to use random ports and enable short connections to save HTTP server resources.

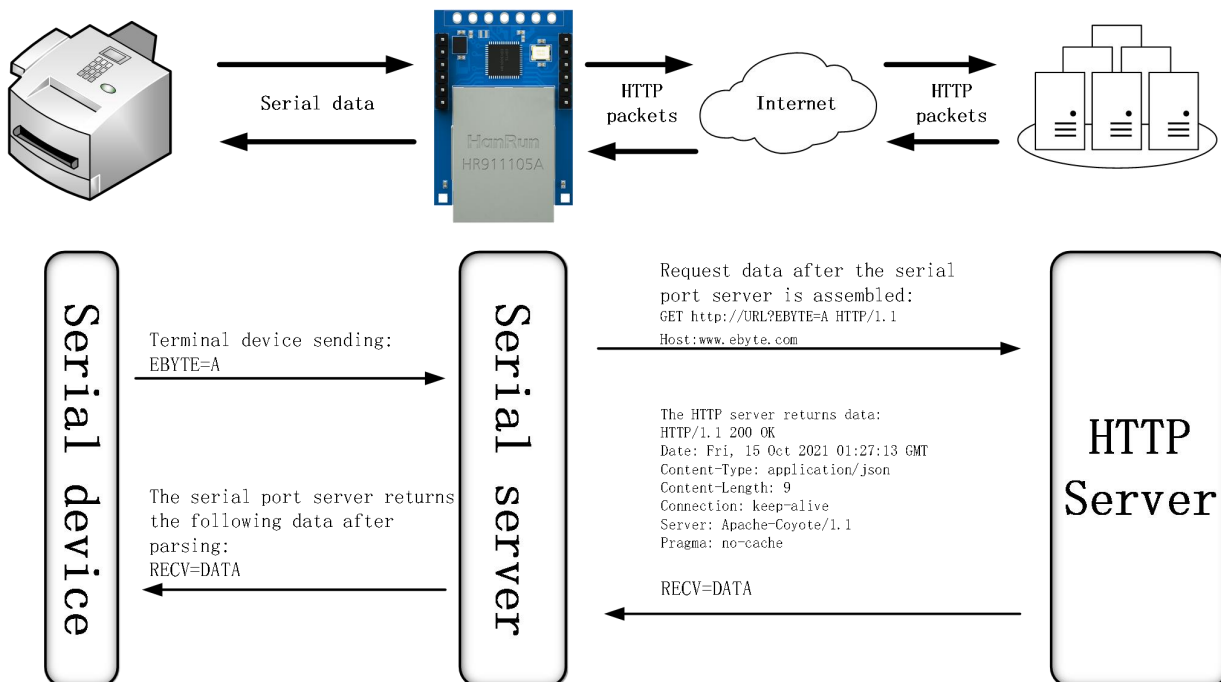

Configure the local network parameters and the HTTP server address and port(You are advised to enable DHCP and random ports), As shown in the figure below(Above is the upper computer, below is the web page):

Network parameters

Device name	A0001	Serial Number	00001
DHCP	Enable	Local port	0
Local IP	192.168.4.162	DNS	192.168.4.1
Mask	255.255.255.0	Web server port	80
Getway	192.168.4.1	Network mode	HTTP client
Remote IP	HTTP Server	Remote port	HTTP Port

Network parameter			
DHCP	enable	Work mode	HTTP client
Local IP	192.168.4.162	Local port	0
MASK	255.255.255.0	Getway	192.168.4.1
Target IP	HTTP Server	Target port	HTTP Port

Return standard HTTP frame data (left image) and only valid data (right image):

<input type="checkbox"/> payload without http head	<input checked="" type="checkbox"/> payload without http head
<input type="checkbox"/> without http head	<input checked="" type="checkbox"/> without http head

Parameter configuration description as shown in the figure (GET on, POST is under):

HTTP parameters

HTTP request GET

HTTP URL URL?

payload without http head

Http head

HTTP HEADER

HTTP parameters

HTTP request GET

HTTP URL URL

payload without http head

Http head

HTTP HEADER

4.3.6 MQTT Client mode

The serial port server supports quick access to standard MQTT3.1.1 protocol servers (OneNET, Baidu Cloud, Huawei Cloud, user-built and other server types) and Alibaba Cloud servers, supports service quality level configuration (QoS 0, QoS 1), and supports super long text Configuration, convenient and better access to network service operators (server address, three elements, subscription and publishing addresses support up to 128 characters of configuration).

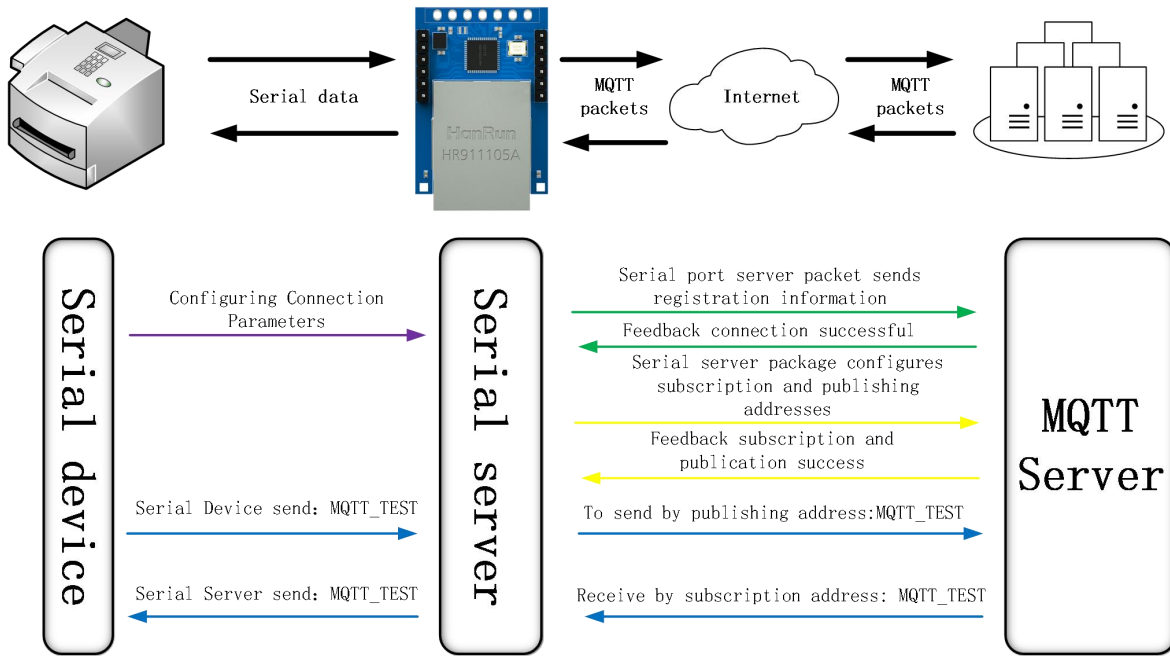

[Note] Data is forwarded based on the rule engine configured on the platform. This section takes sending back as an example

To use MQTT function, advanced Settings such as short links should be turned off as shown in the figure below (upper computer and webpage configuration as shown below) :

Advanced

Reconnection time: 5s Reconnect count: 5freq Empty cache when connected: Enable

No data autoboot time: 300s No data autoboot

Short connection time: 0s Short connection

keepalive mode: Disable Keepalive cycle: 0s

Keepalive content: keepalive message HEX

Registration mode: Disable

Custom registration: register message HEX

Advanced

Outage restart time: 5 <small>Off:0;Range:1-255s</small>	Reconnection times: 5 <small>Range:1-60</small>	Nodata reboot: 300 <small>Off:0;Range:60-65535s</small>
Heartbit cycle: 0 <small>Off:0;Range:1-65535s</small>	Short connection: 0 <small>Off:0;Range:2-255s</small>	NET connected clear cache: Enable
Heartbit mode: Network	Custom heartbeat: keepalive message <input type="checkbox"/> Hex	
Registration mode: Disable	Custom registration: register message <input type="checkbox"/> Hex	

1) standard MQTT3.1.1 and Baidu Cloud and Huawei Cloud and OneNET(Left: software, right: web page)

Network parameters		Network parameter	
Device name: E0001	Serial Number: 00001	DHCP: enable	Work mode: MQTT client
DHCP: Enable	Local port: 8886	Local IP: 192.168.4.101	Local port: 0
Local IP: 192.168.4.101	DNS: 114.114.114.114	MASK: 255.255.255.0	Gateway: 192.168.4.1
Mask: 255.255.255.0	Web server port: 80	Target IP: MQTT Server	Target port: MQTT Port
Gateway: 192.168.4.1	Network mode: MQTT client		
Remote IP: MQTT Server	Remote port: MQTT Port		

MQTT parameters		MQTT client parameter	
MQTT server: typical MQTT 3.1.1	Keepalive cycle: 60s	MQTT server: Standard 3.1.1	keepAlive: 60
Client ID: Client ID		Device name (Client ID): Client ID	
user name (Device name): User Name		user name (Device name): User Name	
Password (Device secret): Password		password (Device secret): Password	
ProductKey: ProductKey		ProductKey: ProductKey	
Subscribe topic: SUB-TOPIC	Qos: 0	Publish topic: SUB-TOPIC	Qos: 0
Publish topic: PUB-TOPIC	Qos: 0	Subscribe topic: PUB-TOPIC	Qos: 0

2) Alibaba Cloud

Alibaba Cloud Supports the use of Alibaba Cloud's "Three Elements" to directly connect to the server to obtain the "Three Elements" required to connect to Alibaba Cloud, as shown in the figure(The following parameters are only examples):

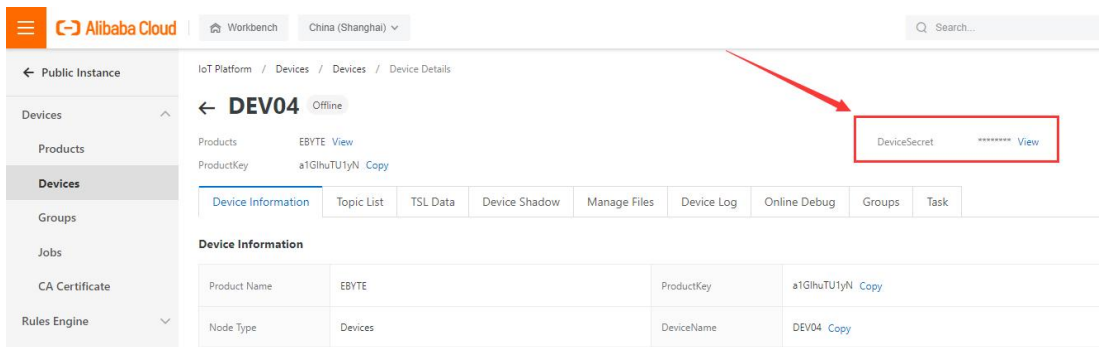

To configure a topic for communication testing:

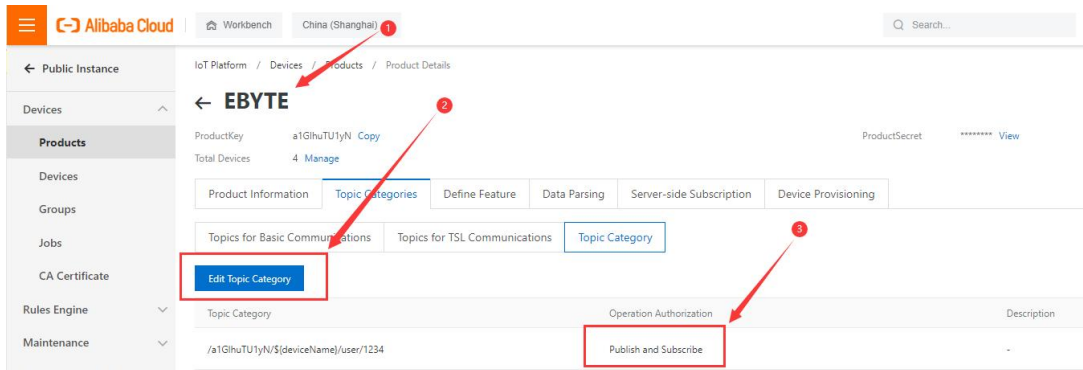

Select the corresponding product, go to "Custom Topic" under the Topic class list (for details, please refer to the Alibaba Cloud documentation), click "Define Topic Class", set the name to 1234, and grant publish and subscribe permissions (for data return pass).

Configure the device connection parameters, as shown in the following figure:

```

{
  "ProductKey": "a1G1huTU1yN",
  "DeviceName": "DEV04",
  "DeviceSecret": "xxxxxxxxxxxxxxxxxxxxxxxxxxxx"
}

```

Alibaba Cloud server address: ProductKey.iot-as-mqtt.cn-shanghai.aliyuncs.com:1883

Topic for subscription and publication: /a1G1huTU1yN/DEV04/user/1234

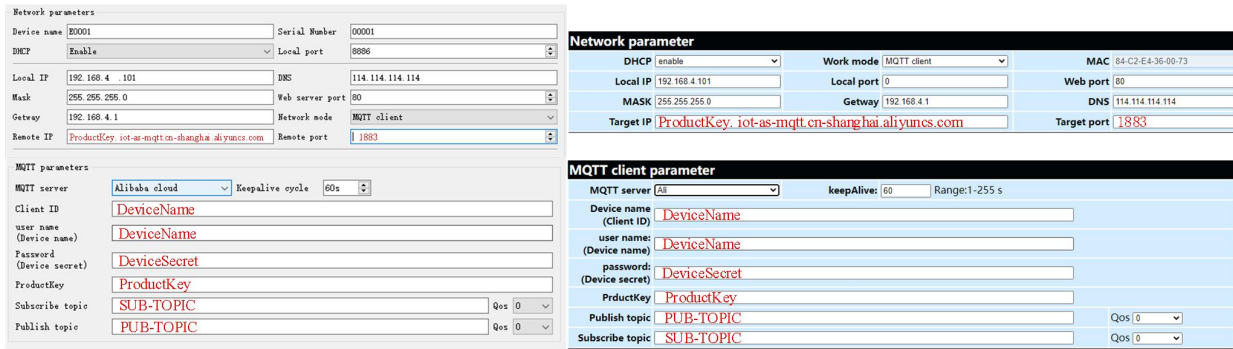

Alibaba Cloud MQTT platform communication test:

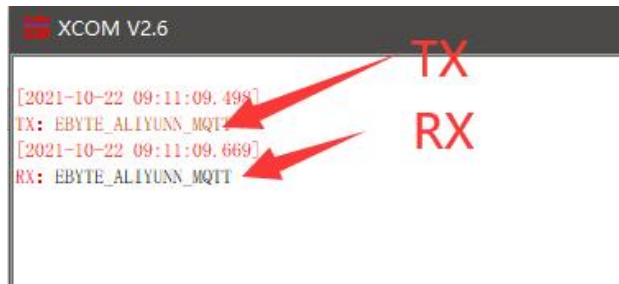

4.4 Advanced Features

4.4.1 Random native port

TCP client, UDP client, HTTP client, MQTT client can configure the local port to 0 (use random local port), and server mode cannot use random port, otherwise the client cannot establish a connection correctly.

Using a random port connection can quickly re-establish the connection when the device disconnects the server unexpectedly, preventing the server from rejecting the connection due to four waves of incompleteness. It is recommended to use a random port in client mode .

The device will automatically enable random ports when configuring the TCP client, HTTP client, and MQTT client modes.

4.4.2 Heartbeat Packet Function

In client mode, users can choose to send heartbeat packets and set the time of heartbeat packets by themselves. The heartbeat packet can be selected in two modes: network heartbeat packet and serial port heartbeat packet. It supports hexadecimal and ASCII transmission. This heartbeat packet is not MQTT heartbeat and needs to be turned off in MQTT client mode. MQTT heartbeat only needs to configure KeepAlive in "MQTT function settings" Time, it is recommended not to configure less than 60s, for example, 120s is recommended in the Alibaba Cloud manual.

Heartbeat packet sending mode:

- (1) The default is to turn off the heartbeat packet mode.
- (2) Serial port mode -> The device sends heartbeat content to the serial bus according to the set heartbeat interval.
- (3) Network port mode -> The device sends heartbeat content to the network port bus according to the set

heartbeat interval.

Customize heartbeat packet content (maximum support 40 bytes (ASCII) data, 20 bytes (HEX) data)

Customize the interval for sending heartbeat packets. When it is set to 0, the heartbeat packet function is turned off. If the setting value is greater than zero, the heartbeat packet function is turned on. When it is turned on, the range can be set: (1-65536) seconds.

4.4.3 Registration package function

In the client mode, the user can choose to send the registration package, and set the registration package time by definition.

The registration package supports the following modes:

(1) The MAC address (OLMAC) is sent when the network establishes a connection with the device

(2) The data of the custom registration package sent when the network establishes a connection with the device (OLCSTM)

(3) After the network and the device are connected, each packet of data sent by the device to the network is preceded by a MAC address (EMBMAC)

(4) After the network and the device are connected, each packet of data sent by the device to the network is prepended with custom registration packet data (EMBCSTM)

Custom registration package content (maximum support 40 bytes (ASCII) data, 20 bytes (HEX) data)

4.4.4 Short connection function

In client mode, short network connection is supported (this function is disabled by default). TCP short connection is mainly used to save server resource overhead, and is generally used in multi-point (multi-client)-to-point (server) scenarios.

In client mode, short network connection is supported (this function is disabled by default). TCP short connection is mainly used to save server resource overhead, and is generally used in multi-point (multi-client)-to-point (server) scenarios.

When the short link hold time is set to 0, the short link function is turned off. When the setting range is (2-255) seconds, the short connection function is enabled, and the default hold time is 0 seconds (disabled).

4.4.5 Timeout restart function

Supports the timeout restart function (default: 300 seconds), which is mainly used to ensure the long-term stable operation of the device. If data is not sent and received within the set timeout restart time, the device will restart to avoid the impact of abnormal conditions on communication.

The parameter range of timeout restart time is (60-65535) seconds. If it is set to 0, it means shutdown timeout restart. The default is 300 seconds.

4.4.6 Cache cleaning function

The device is in the client mode. When the TCP connection is not established, the data received by the serial port will be placed in the buffer area. The serial port receiving buffer is 1024 bytes, and the data larger than 1024 bytes will cover the earliest received data. After the network connection is successful, you can Select to clear the serial port cache or send the cache through the network through configuration.

Enable: The device does not save the data received by the serial port before the connection is established.

Disabled: After the connection is established, the network will receive the serial buffered data.

4.4.7 Network disconnection and reconnection

In client mode, after the device is disconnected from the network, it will try to actively connect to the server at the specified time. If the request times out and the set number of reconnections has not been successfully reconnected, the device will restart to prevent the device from disconnecting from the network. Unable to restore connection. Disconnection and reconnection time: The time interval between each attempt of the device to re-establish the network. Number of reconnections: The number of times the device tries to re-establish the network, and the cumulative number of requests reaches the preset value. If the connection is not successful, the device will automatically restart. The actual restart time is the network disconnection reconnection period multiplied by the number of reconnections. It is recommended to use the factory default parameters without special requirements.

4.4.8 Remote upgrade

In order to facilitate later maintenance and upgrade functions and to replace different firmware, the serial server (NA11x series, NB114, NS1, NT1, etc.) supports online upgrade, and users can upgrade or replace the current firmware through the upgrade firmware provided by our company through the host computer.

Network upgrade firmware operation steps:

Step 1: Open the host computer, open the device upgrade assistant in the menu bar, and select the required firmware (The official website only provides the latest firmware, please refer to "Firmware Instructions" for details);

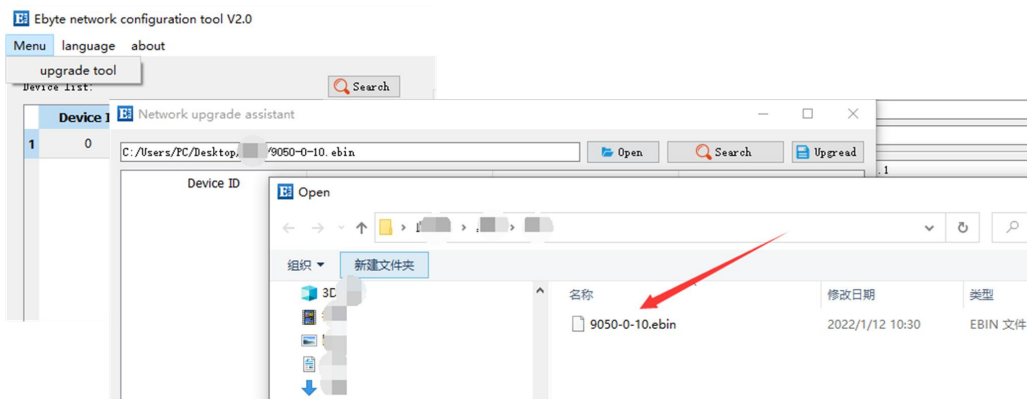

Step 2: Click to search for devices, and click to stop searching after finding the device;

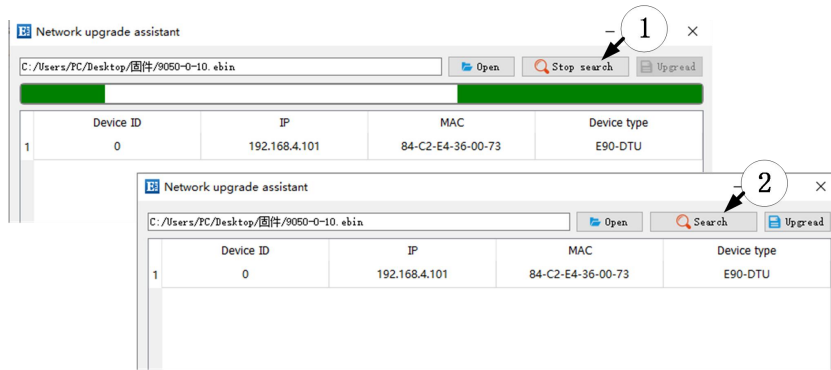

Step 3: Select the corresponding device that needs to be upgraded;

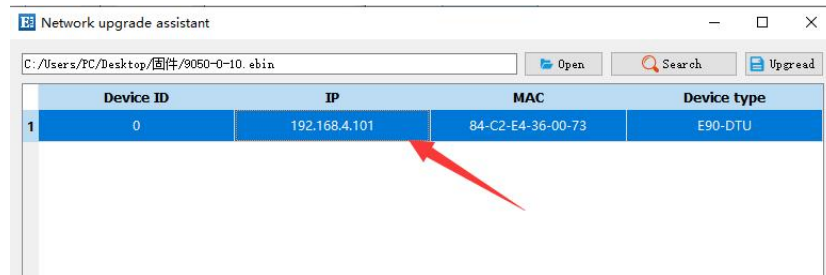

Step 4: Click to start the upgrade, the device indicator flashes, and wait for the upgrade to complete.

[Note] When the device is just powered on, click "Search Device" in the upgrade assistant, the device will enter the firmware burning state, and it will return to normal mode after power off and restart.

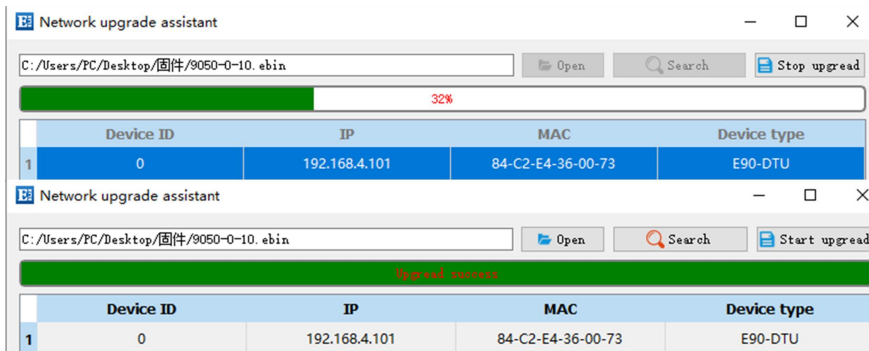

4.5 Modbus Gateway

4.5.1 Modbus RTU and Modbus TCP protocol conversion

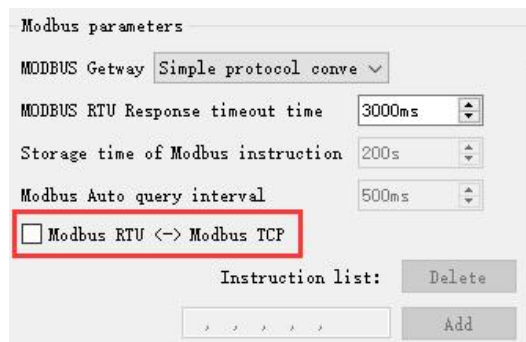

Enable(Check): Convert Modbus RTU protocol to Modbus TCP protocol.

Disabled: Do not perform protocol conversion but verify Modbus data, discard non-Modbus data (RTU/TCP) and not transmit.

4.5.2 Simple Protocol Conversion Mode

Convert Modbus RTU data to Modbus TCP data, or convert Modbus TCP data to Modbus RTU data, to realize the mutual conversion of Ethernet Modbus data and serial port Modbus data.

Simple protocol conversion can work in any mode (TCP client, TCP server, UDP client, UDP server etc.), no matter what mode it is working in, there can only be one Modbus master station.

Simple protocol conversion configuration (TCP server mode as an example, the upper computer on the left, web page on the right) :

Network parameter			
DHCP	disable	Work mode	TCP server
Local IP	192.168.4.164	Local port	0
MASK	255.255.255.0	Getway	192.168.4.1
Target IP	192.168.3.100	Target port	5000
MAC		84-C2-E4-36-07-B7	
Web port		80	
DNS		192.168.4.1	

MODBUS parameter			
MODBUS TCP to RTU	Open	Mosbus instructions	
Modbus mode	Simple	MODBUS Query time	500
Modbus timeout	1000	MODBUS keep time	10
Range:0-65535ms		Range:0-255s	
Instruction format: "XX XX XX XX XX XX";"XX" is a 2-digit hexadecimal number. Must add a space between "XX" and "XX" Up to 50 instructions can be configured			

4.5.3 Multi-host mode

There is only one Modbus master station for relatively simple protocol conversion, while the multi-master mode can handle up to 6 Modbus TCP masters. One request is processed at a time, while the multi-host mode will be sequenced according to the TCP request, and other links will wait) to solve the bus conflict problem (currently only 6 host connections are supported), only supports working in TCP server mode, slave machine Only in the serial port, otherwise it will not work properly.

It is recommended to configure "Simple Protocol Conversion" when no multi-channel host is used.

Multi-host mode configuration (upper computer, web page below) :

Network parameter			
DHCP	disable	Work mode	TCP server
Local IP	192.168.4.101	Local port	8886
MASK	255.255.255.0	Getway	192.168.4.1
Target IP	192.168.4.100	Target port	8887
MAC		84-C2-E4-36-00-73	
Web port		80	
DNS		192.168.4.1	

MODBUS parameter			
MODBUS TCP to RTU	Open	Modbus mode	Multi host
Modbus timeout	3000	Modbus timeout	3000
Range: 0 - 65535ms			

4.5.4 Storage Gateway

The storage gateway not only arbitrates the bus data but also stores the repeated read commands. When different hosts request the same data, the gateway does not need to query the register status of the RTU device multiple times, but directly returns the data cached in the storage area. To a certain extent, the multi-host request processing capability of the gateway is improved, and the time consumed by the entire request process is also shortened. Users can customize the storage area command polling interval and command storage time according to their needs.

As the optimization of multi-host request performance, the storage gateway can only work in the TCP server mode, which improves the response speed of the network side.

Features:

- (1) The gateway has a 5K cache for storing instructions and returning results (reading 10 holding registers as an example, it can store 189 instructions and return results);
 - (2) The RTU response time-out automatically clears the cache to ensure the real-time and authenticity of the data;
 - (3) The polling interval can be customized, 0-65535ms;
 - (4) The gateway will poll the RTU device according to the storage time of the instruction used for configuration. If the MODBUS host does not query the instruction again during the storage time, the gateway will automatically delete the storage instruction to release the cache;
 - (5) The first command and control command (05, 06, 0F, 10 function codes) will directly access the RTU device;
 - (6) Only 01, 02, 03, 04 Modbus function code query result storage is supported;
- Storage gateway configuration (upper computer, web page) :

Network parameter				MODBUS parameter			
Device name	E0001	Serial Number	00001	MODBUS Gateway	Storable gateway	MODBUS RTU Response timeout time	3000ms
DHCP	Disable	Local port	8886	Storage time of Modbus instruction	200s	Modbus Auto query interval	500ms
Local IP	192.168.4.101	DNS	192.168.4.1	<input checked="" type="checkbox"/> Modbus RTU <-> Modbus TCP			
Mask	255.255.255.0	Web server port	80				
Gateway	192.168.4.1	Network mode	TCP server				
Remote IP	192.168.4.100	Remote port	8887				

4.5.5 Configurable Gateway

The gateway automatically polls the RTU device registers according to the pre-configured MODBUS commands (only supports the configuration of the MODBUS read command), and the commands in the non-storage table will directly operate the RTU device. Frequently read commands can be stored in the gateway in advance, which can shorten the response time (query configured commands). Due to the above features, the serial port side of the configurable gateway can only be connected to Modbus slaves.

Add instruction, left for the upper computer, right for the web page

Instruction storage description (Add instruction, Left picture software right picture web page):

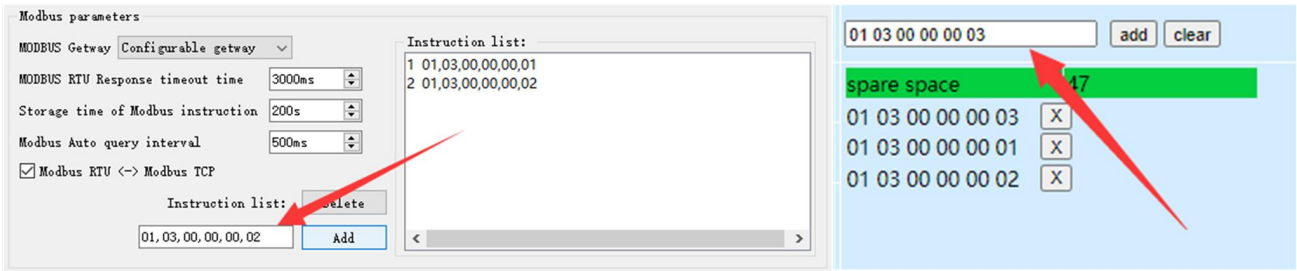

Instruction storage description (Delete, Left picture software right picture web page):

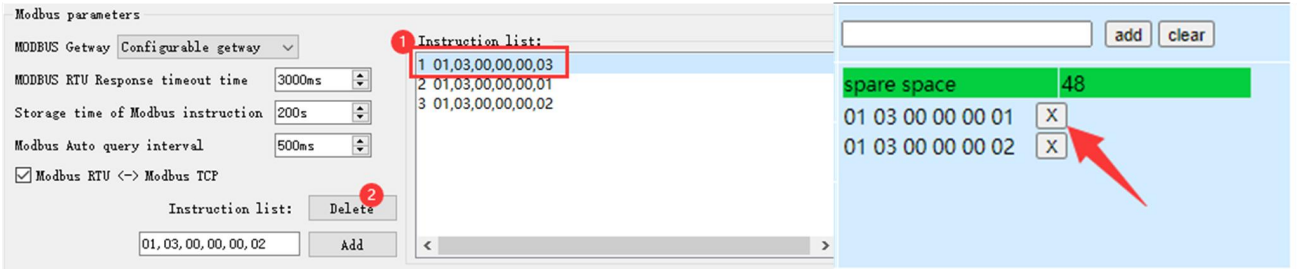

Clear instructions:

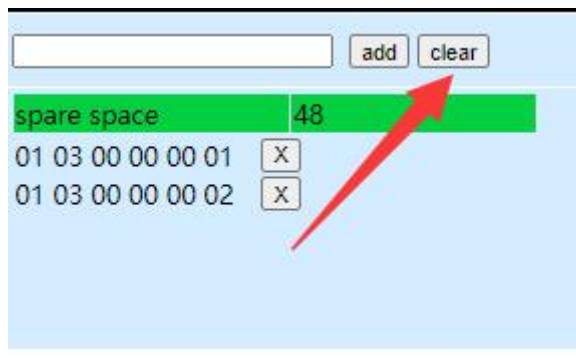

Configurable gateway configuration (Left picture software right picture web page) :

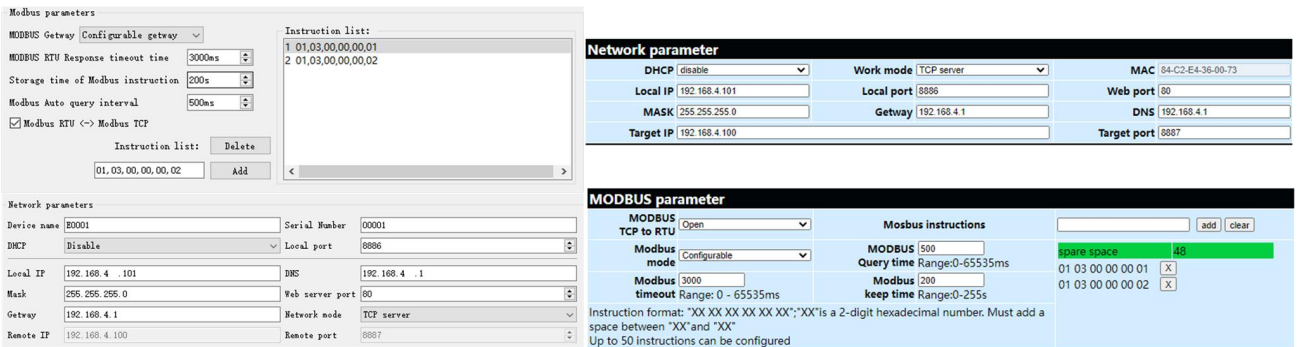

4.5.6 Automatic upload

In client mode (TCP client, UDP client etc.), the gateway will automatically poll the instructions in the stored instruction table and upload it to the server, and the feedback format (Modbus RTU format or Modbus TCP format) can be selected according to the requirements.) and the command polling interval (0-65535ms).

For instruction pre-storage, refer to "Configurable Gateway - Instruction Storage Instructions", and automatically upload the upper computer/web page configuration:

Network parameters

Device name: E0001 Serial Number: 00001

DHCP: Disable Local port: 0

Local IP: 192.168.4.101 DNS: 192.168.4.1

Mask: 255.255.255.0 Web server port: 80

Gateway: 192.168.4.1 Network mode: TCP client

Remote IP: 192.168.4.100 Remote port: 8887

Modbus parameters

MODBUS Gateway: AutoUpdate

MODBUS RTU Response timeout time: 3000ms

Storage time of Modbus instruction: 200s

Modbus Auto query interval: 500ms

Modbus RTU (<-> Modbus TCP)

Instruction list:

1	01,03,00,00,00,01
2	01,03,00,00,00,02

Instruction list: Delete Add

Network parameter

DHCP: disable	Work mode: TCP client	MAC: 84-C2-E4-36-09-73
Local IP: 192.168.4.101	Local port: 0	Web port: 80
MASK: 255.255.255.0	Gateway: 192.168.4.1	DNS: 192.168.4.1
Target IP: 192.168.4.100	Target port: 8887	

MODBUS parameter

MODBUS TCP to RTU: Close

Modbus mode: Auto update

Modbus timeout: 3000ms

Mosbus instructions:

MODBUS: 500	spare space: 48
Query time Range: 0-65535ms	01 03 00 00 00 01 X
Modbus: 200	01 03 00 00 00 02 X
keep time Range: 0-255s	

Instruction format: "XX XX XX XX XX XX"; "XX" is a 2-digit hexadecimal number. Must add a space between "XX" and "XX". Up to 50 instructions can be configured

TCP client demo (Modbus RTU format on the left and Modbus TCP format on the right):

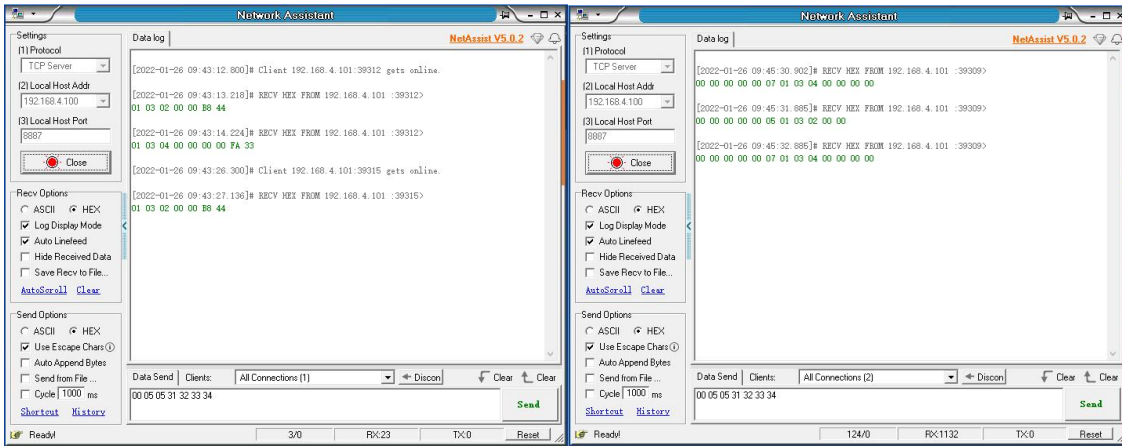

5 Configuration Mode

5.1 Web Settings

You can customize the relevant parameters through the Web setting method. Open the browser, enter the device IP in the address bar (default: 192.168.3.7), enter the page, you can query and set parameters, and finally click the "Submit" menu to wait for the page to return to the successful prompt, and it will take effect.

Note: Do not enter the web page configuration during normal use, which may cause data loss. If you enter the web page configuration, you need to restart to enter the communication mode.

Web page configuration initialization password: 123456, can be customized configuration, only supports 6-bit uppercase and lowercase letters and numerical configuration.

The webpage configuration requires browsers with newer kernels to work properly, such as Microsoft Edge (96.0.1054.62), Google chrome (96.0.4664.110), Firefox (95.0.2), etc.

[Note] IE, 360 compatibility mode, QQ browser compatibility mode and other browsers using IE core are not supported to use web page configuration.

5.2 Configuration tool software settings

Open the configuration tool software, search for devices, double-click the identified device, and the parameter query configuration interface will pop up. You can customize and modify relevant parameters according to your needs, then save the configuration, restart the device, and complete the parameter modification.

[Note] :

Do not use multiple host computers in the same local area network environment. Multi-network card industrial computers need to temporarily disable and do not use network cards, otherwise the host computer will not be able to search for devices normally (the same device is displayed multiple times, no device can be found, etc.)

The host computer shields the wireless network card, so the network cable must be connected to use the host computer, and the wireless network card can be configured through the web page.

5.3 AT command configuration

The query and modification of relevant parameters of the device can be completed through AT command configuration. For specific AT commands, please refer to "NA11x&NT&NS-AT Command Set".

Revision history

Version	Date	Description	Issued by
1.0	2021-06-28	Initial version	LC
1.1	2022-09-13	Content revision	LZX
1.2	2022-02-12	Adapt to "9013-2-xx" firmware	LC
1.3	2022-07-29	Change manual illustration	LC
1.4	2023-10-18	Added IO interface description	LY

About us

Technical support: support@cdebyte.com

Documents and RF Setting download link: www.ebyte.com

Thank you for using Ebyte products! Please contact us with any questions or suggestions: info@cdebyte.com

Phone: +86 028-61399028

Web: www.ebyte.com

Address: B5 Mould Park, 199# Xiqu Ave, High-tech District, Sichuan, China