

X-1-2

X-1-1

X-3-1

Y-3

Y-4

X-2-2

No.1

X-3-2

X-2-3

X-4-1

X-6-1

No.2

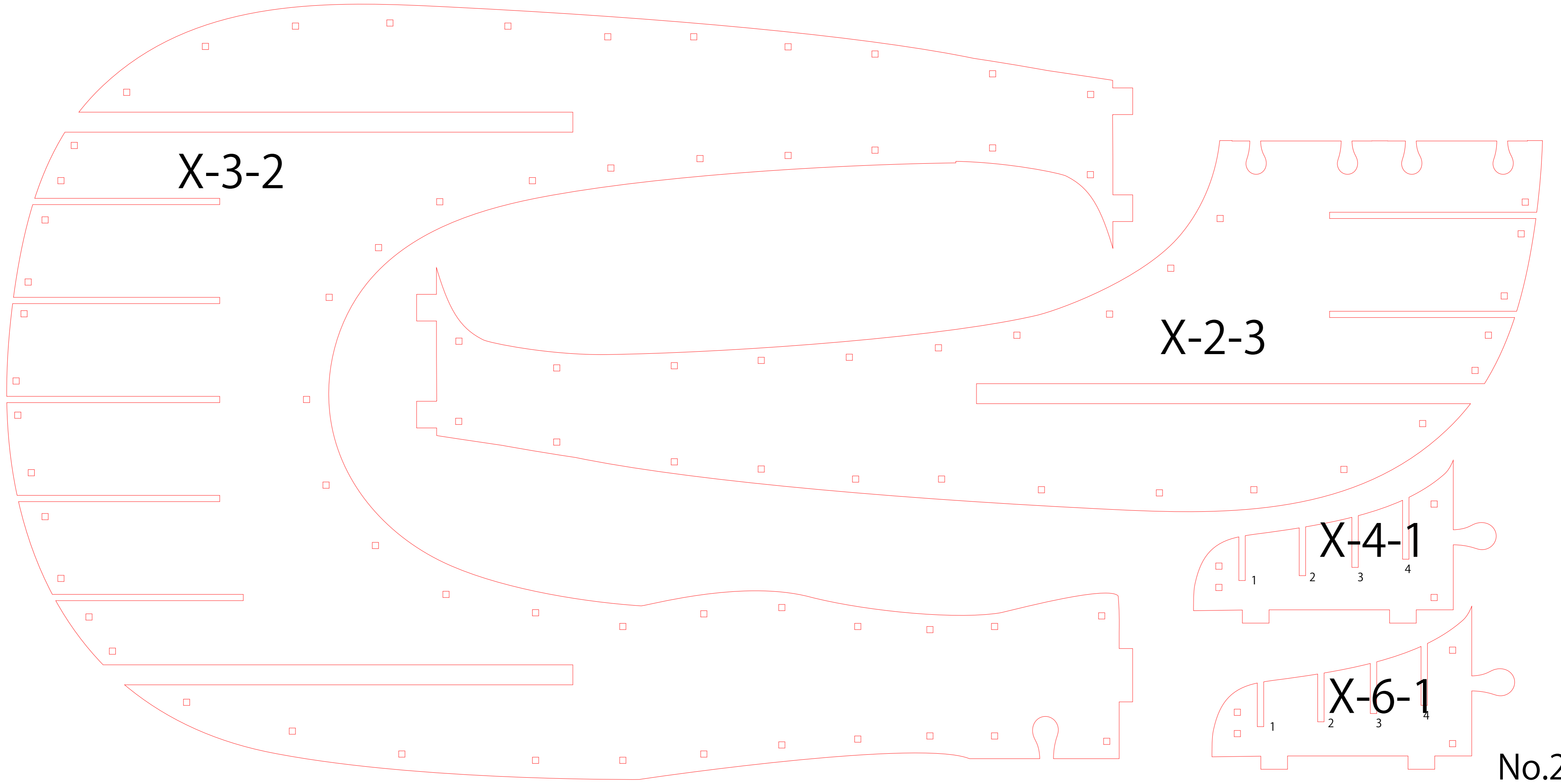

X-4-2

X-2-1

1 2 3 4

X-5-2

Y-2

Y-1

No.3

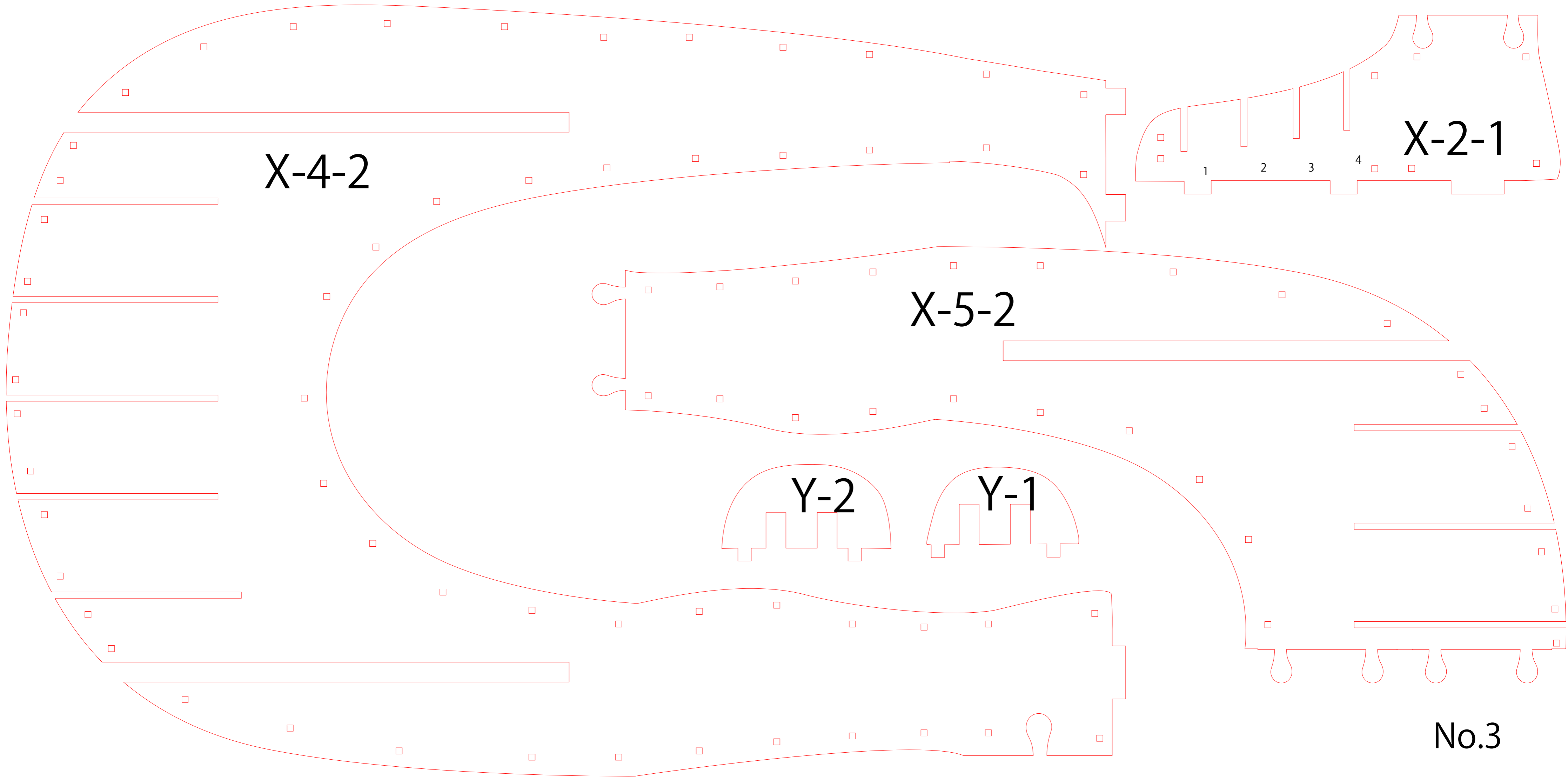

X-6-2

Z-1-left-foot

foot nail

X-5-1

X-5-3

No.4

Z-2-left-foot

1 2 3 4

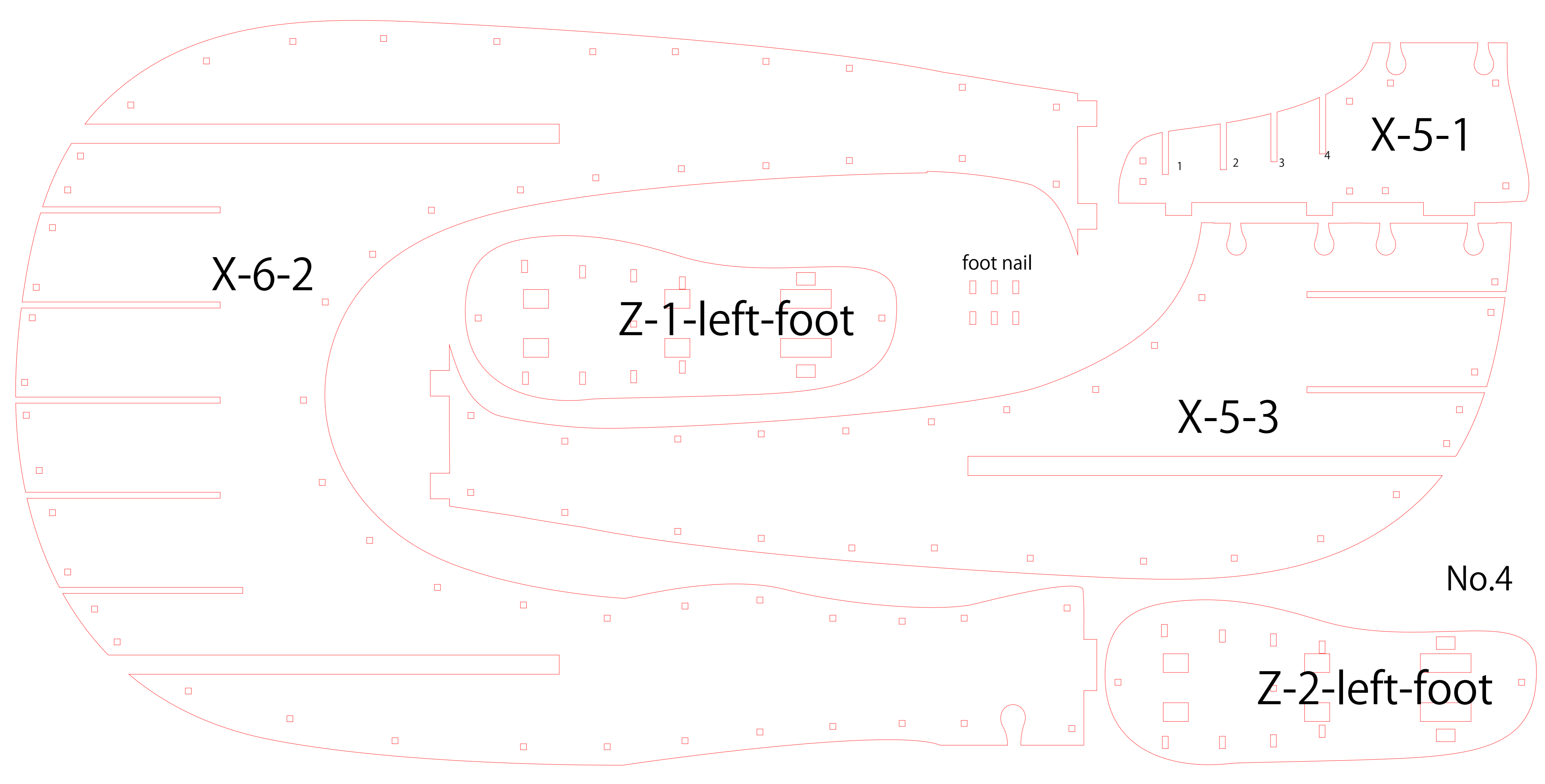

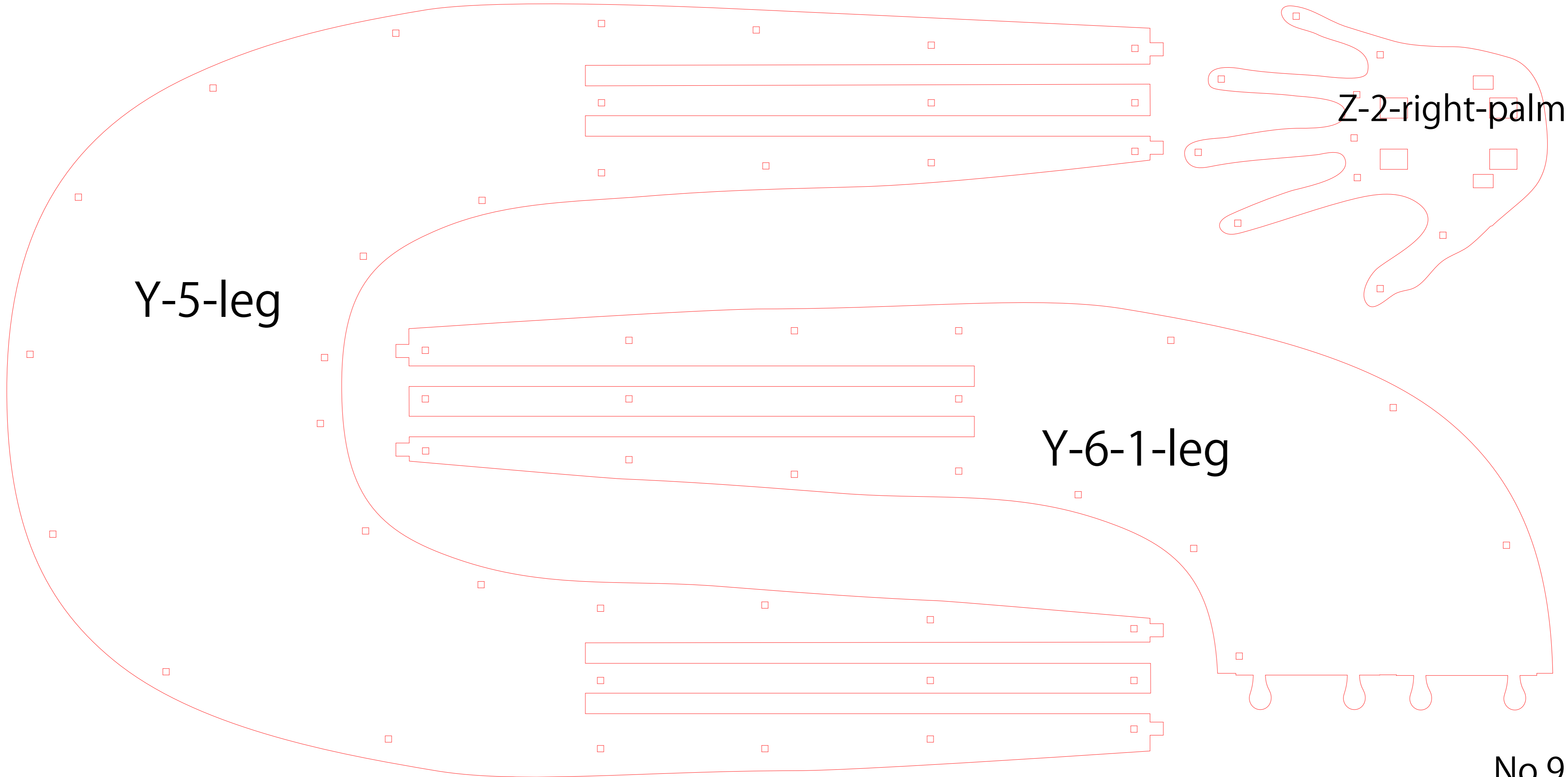

Y-5-leg

Y-6-1-leg

Z-2-right-palm

No.9

Y-7-leg

Y-6-2-leg

Z-2-left-palm

No.10

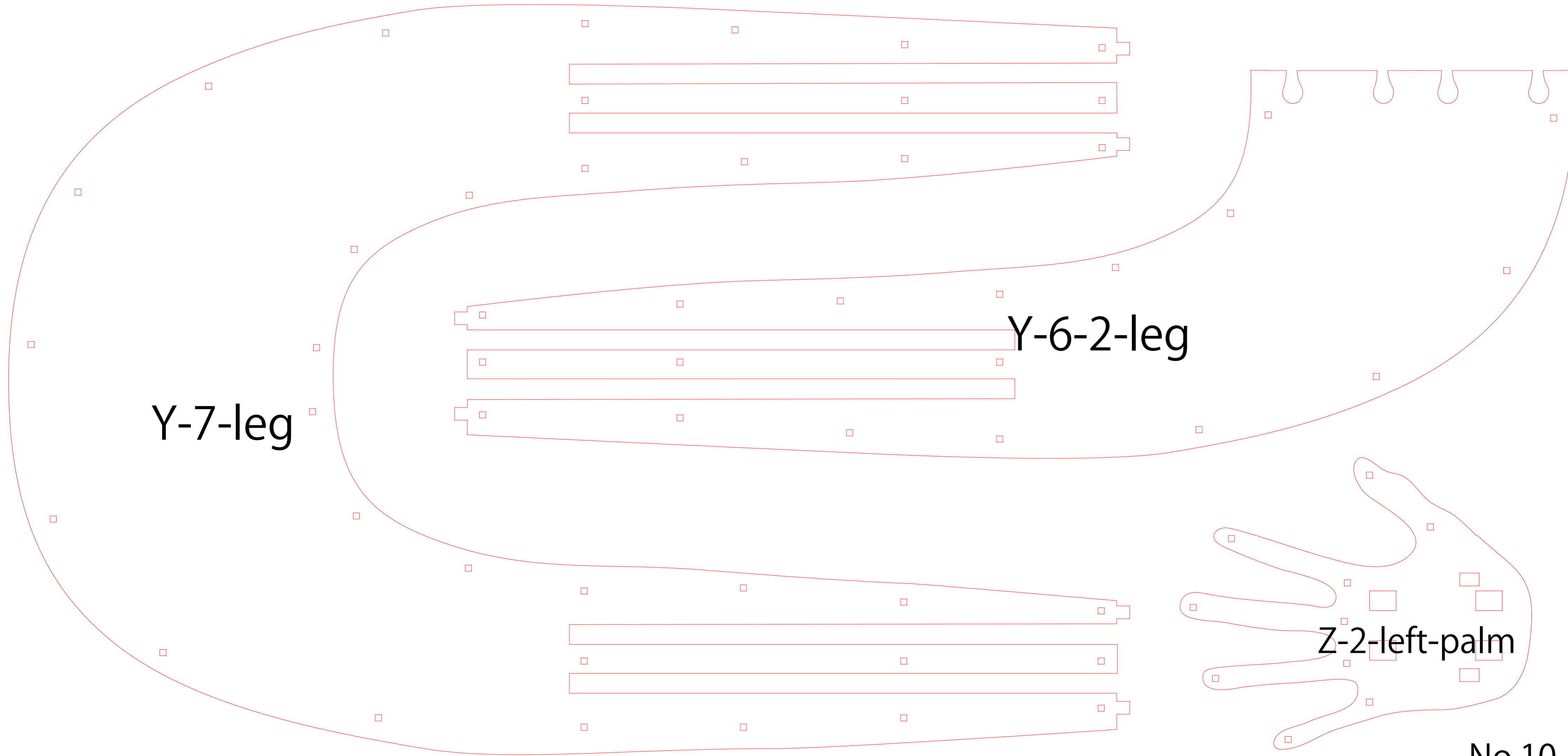

Y-13-hand

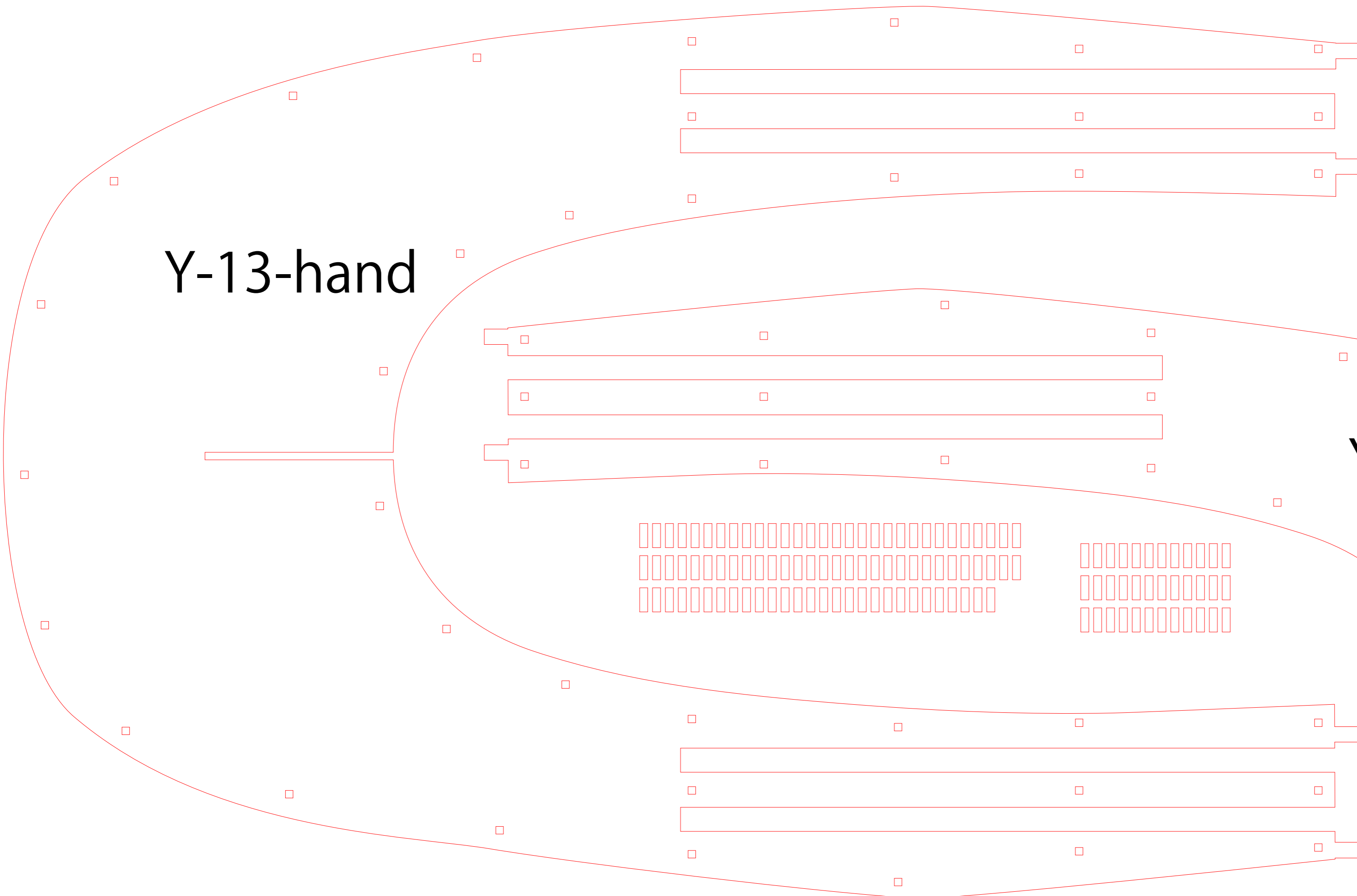

Z-3-right-palm

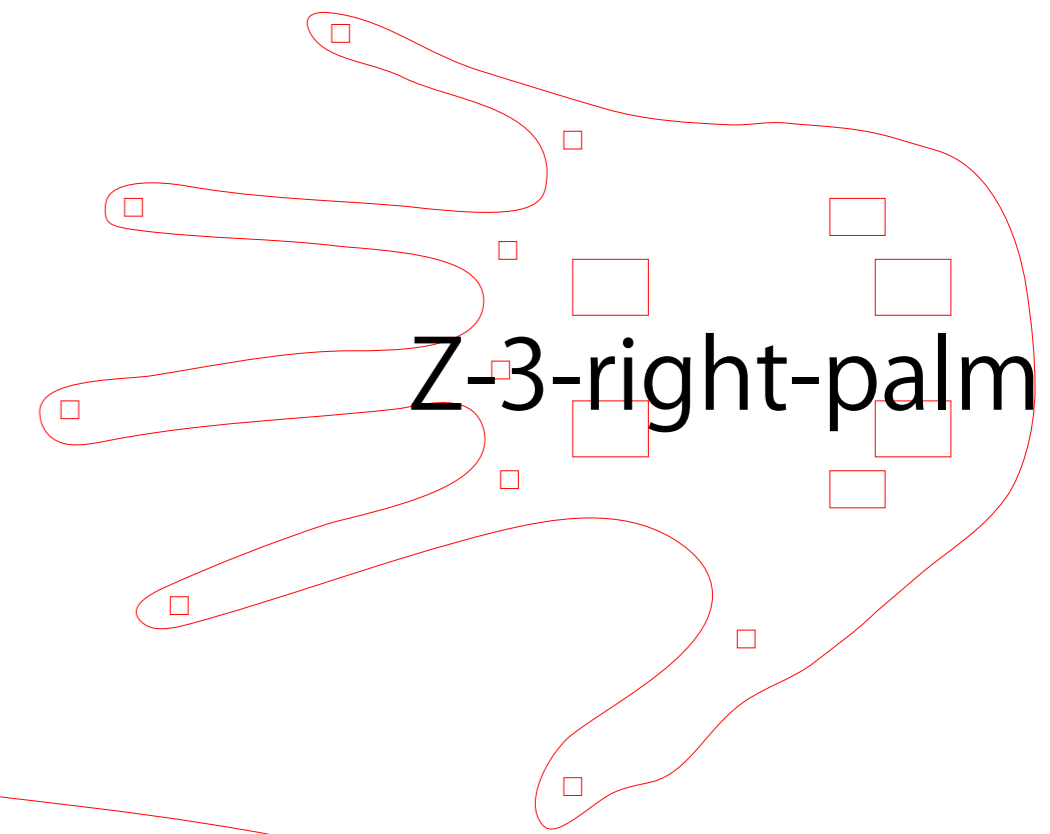

Y-14-1-hand

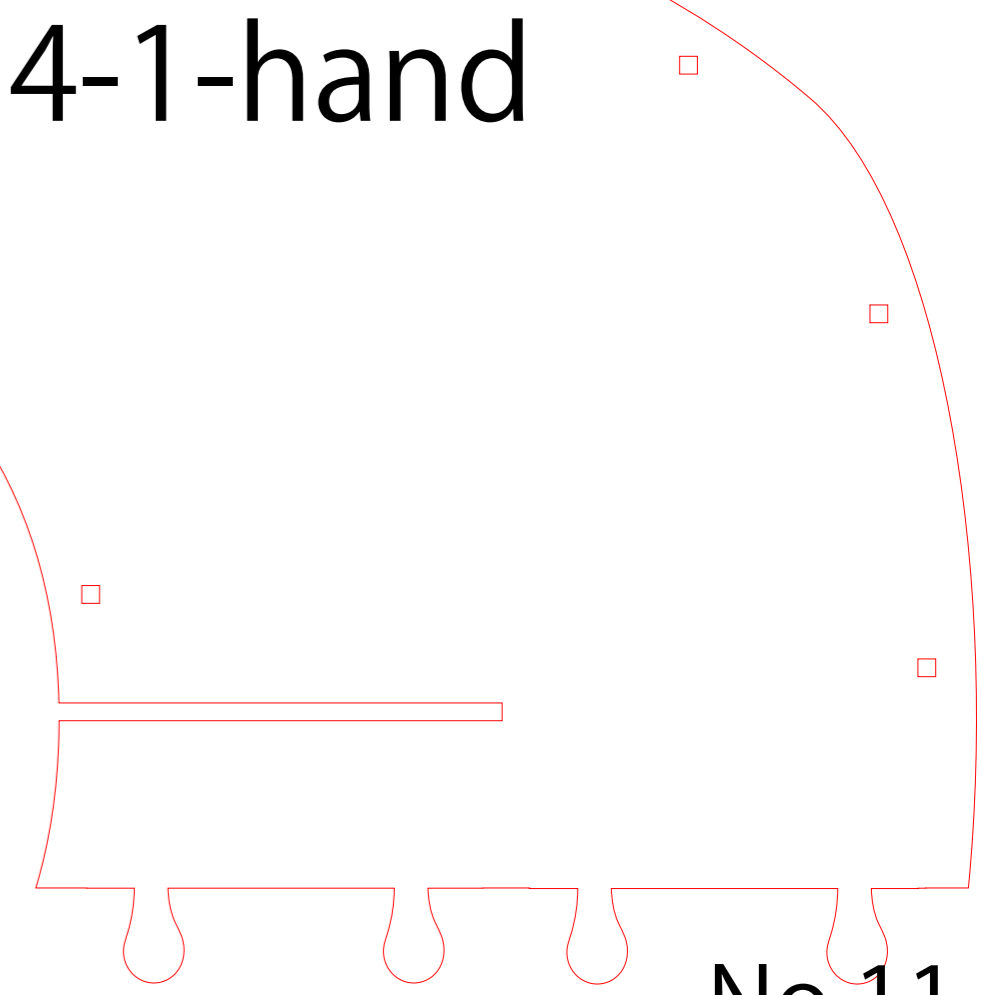

No.11

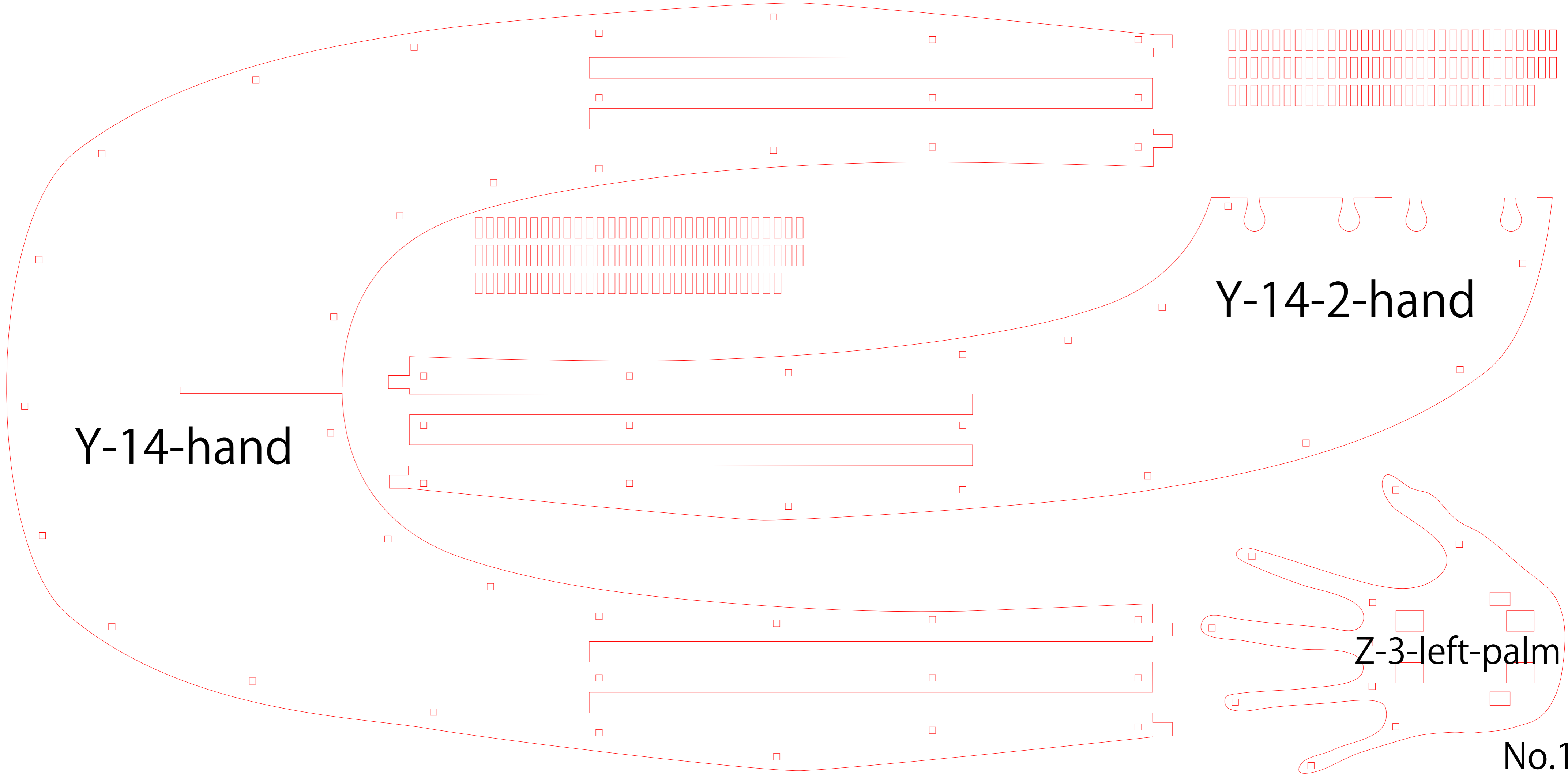

Y-14-hand

Y-14-2-hand

Z-3-left-palm

No.12



X-10-2

X-8-1

1 2 3 4

X-11-2

Y-2

Y-1

No.7

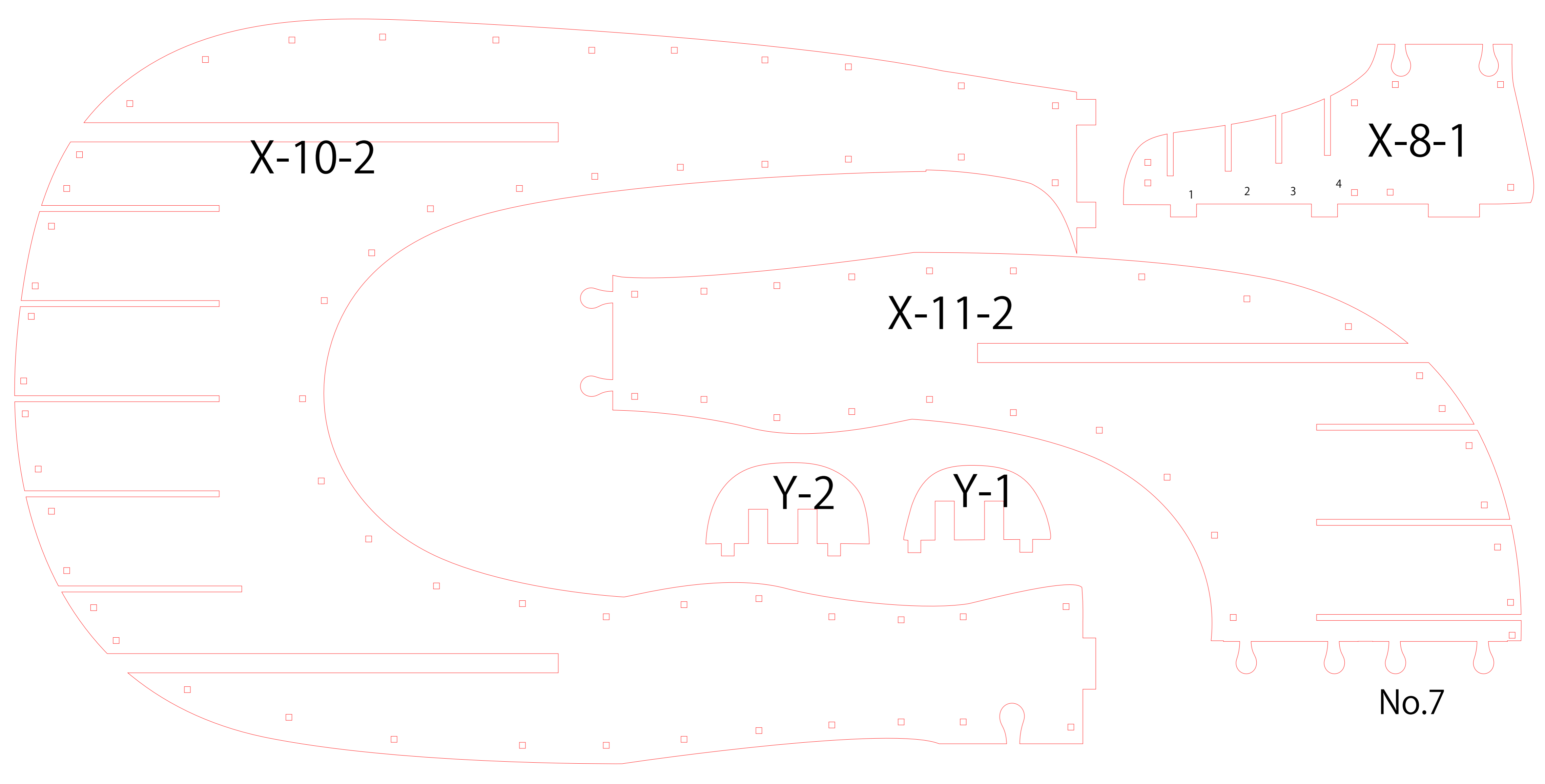

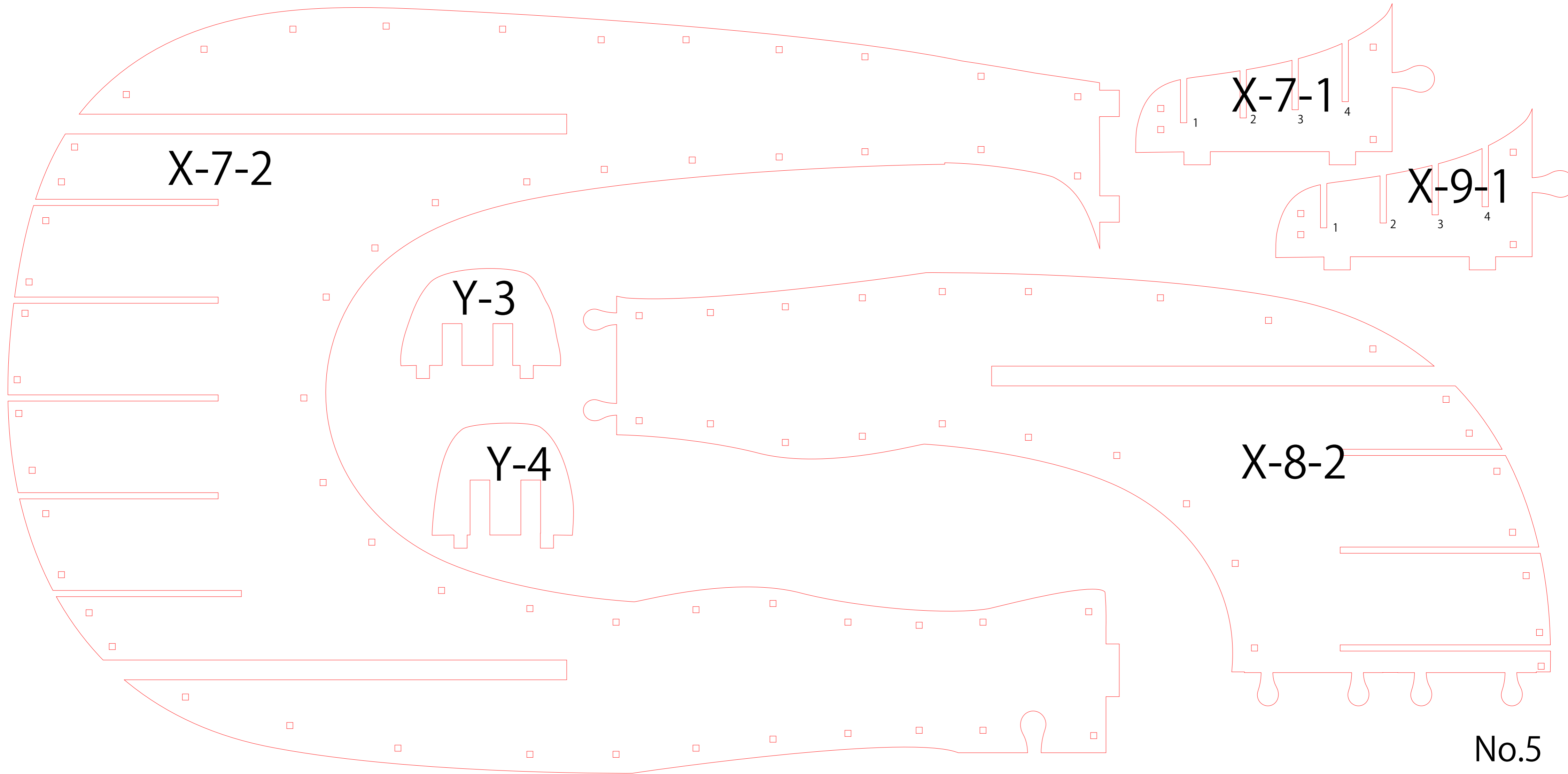

X-9-2

X-8-3

X-10-1

X-12-1

No.6

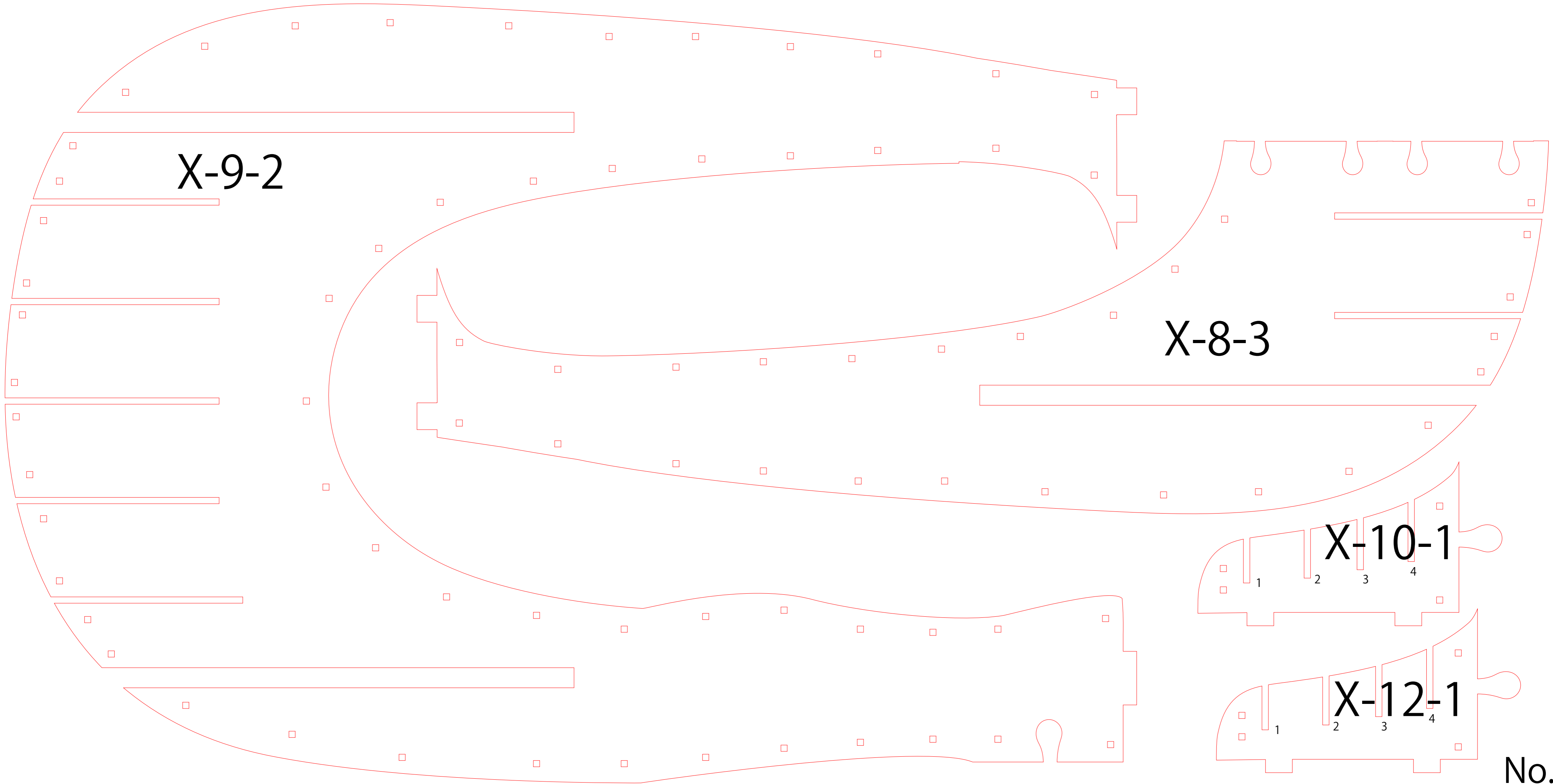

X-12-2

Z-1-right-foot

X-10-1

X-11-3

No.8

Z-2-right-foot

1 2 3 4

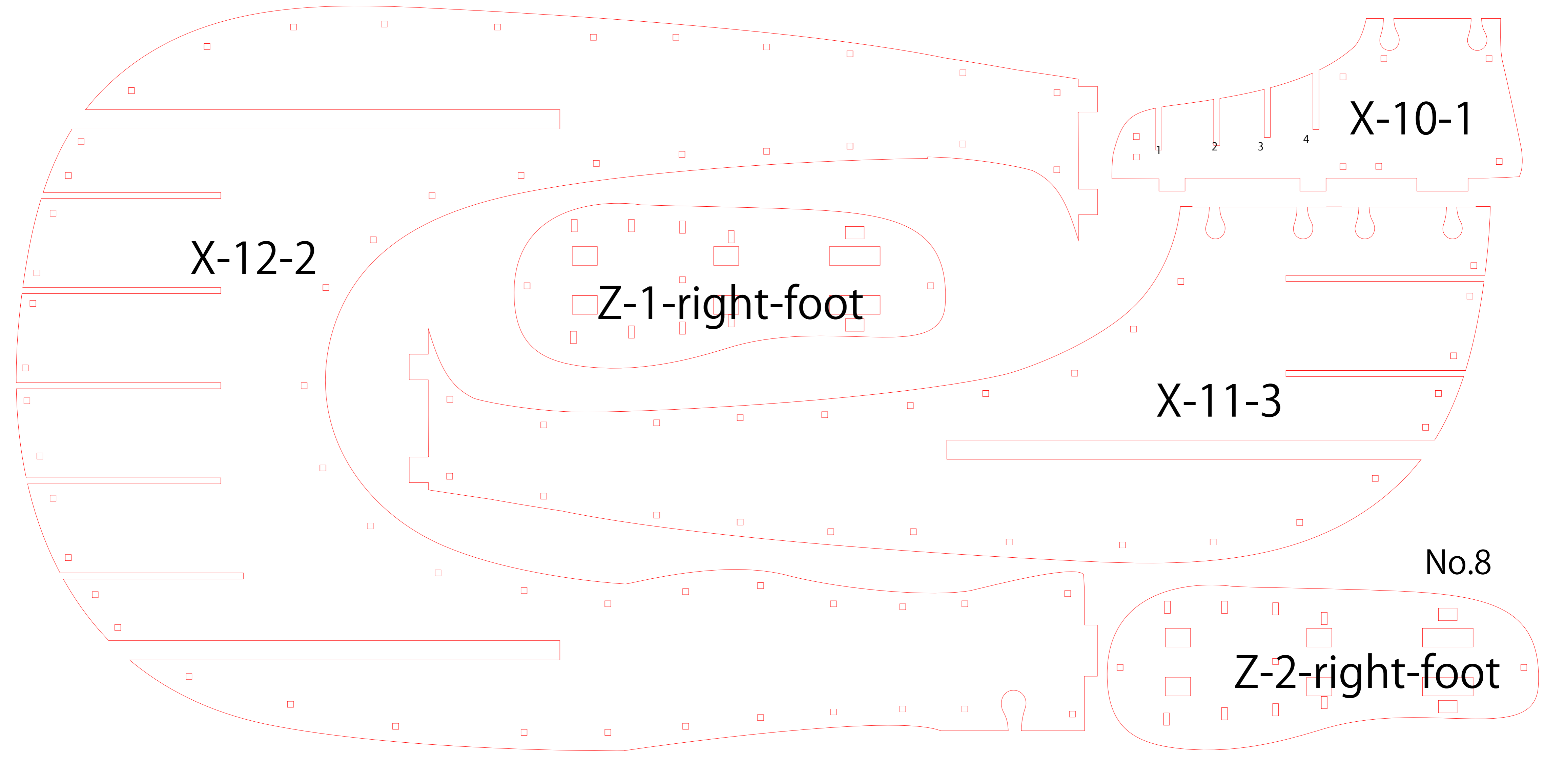

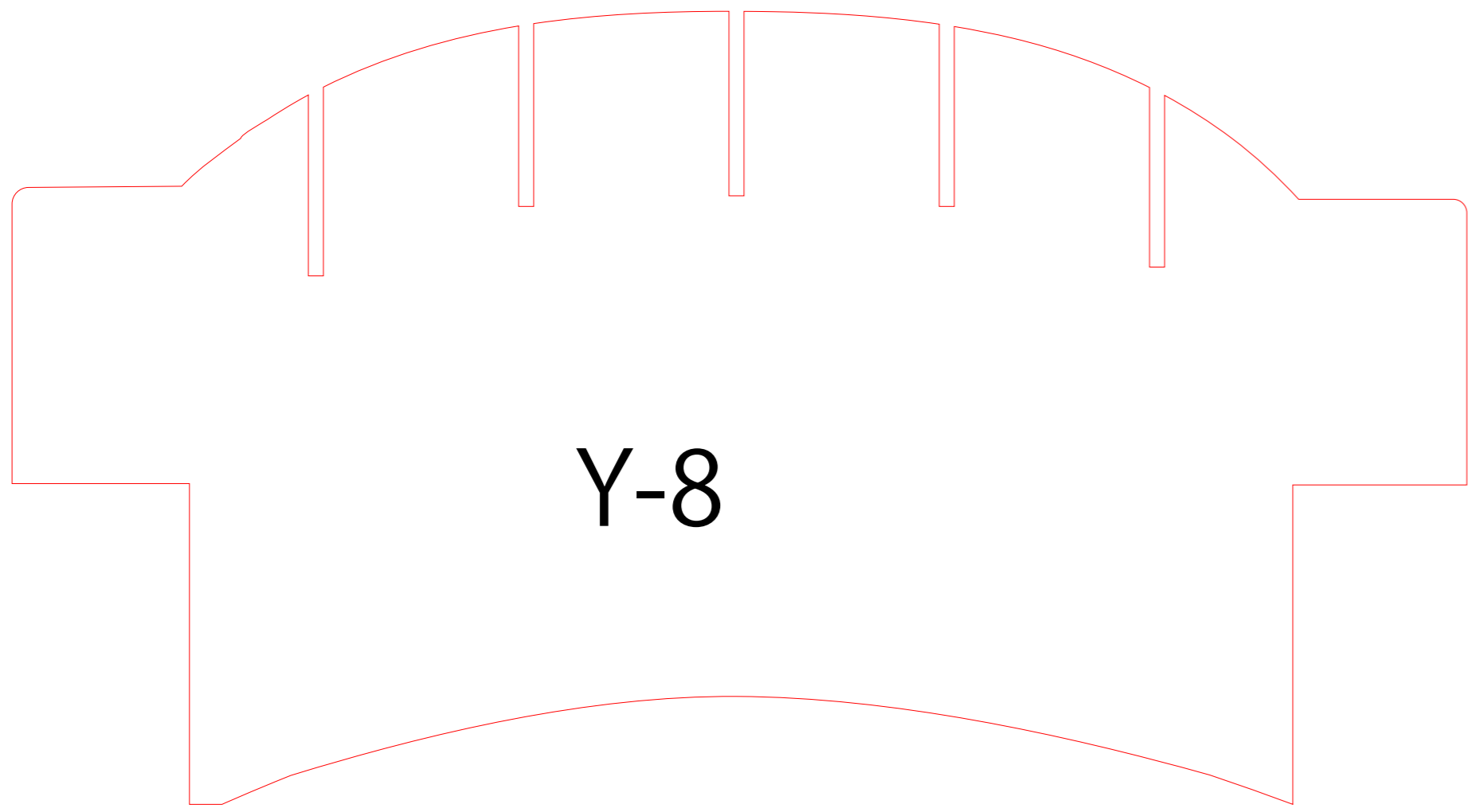

Y-8

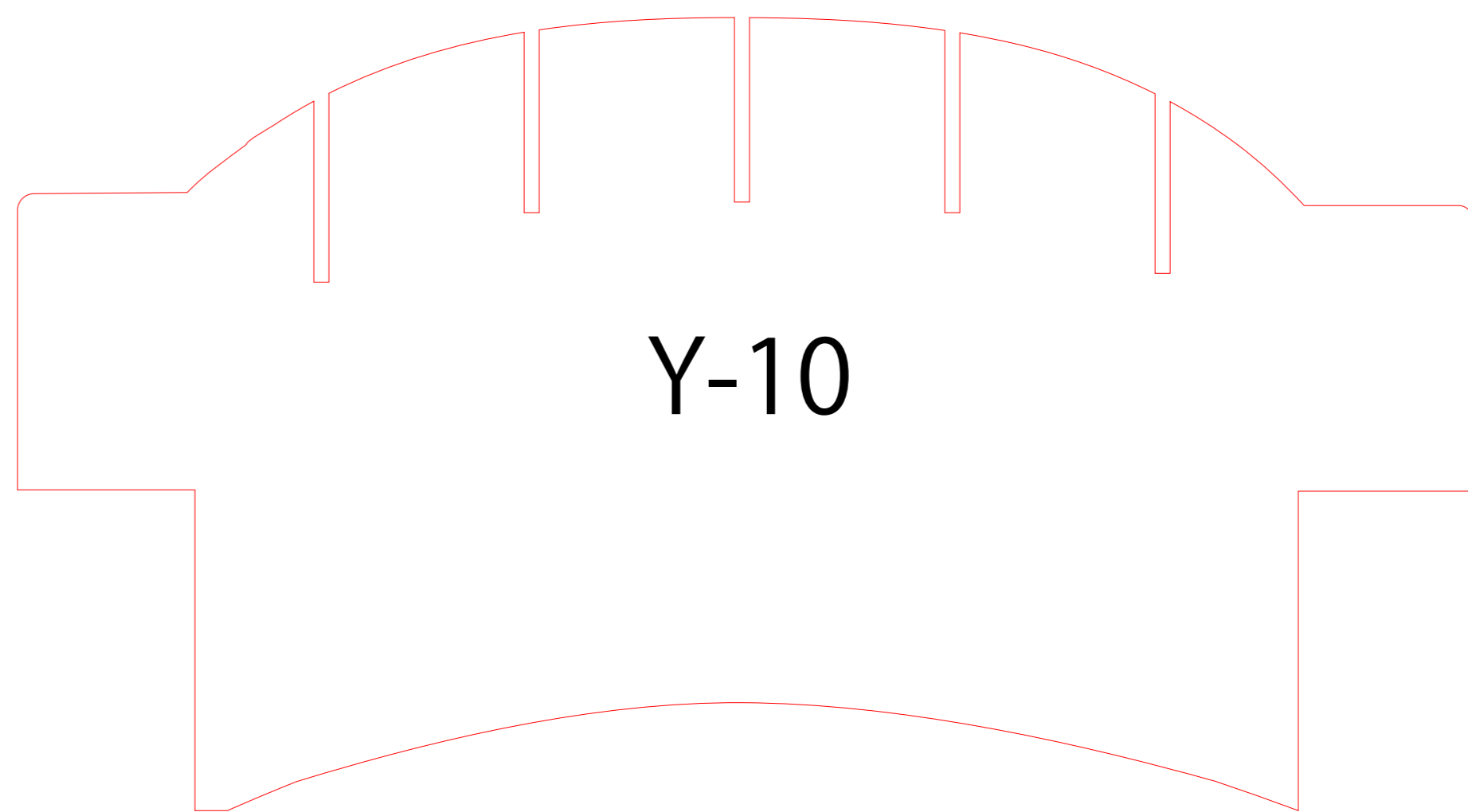

Y-10

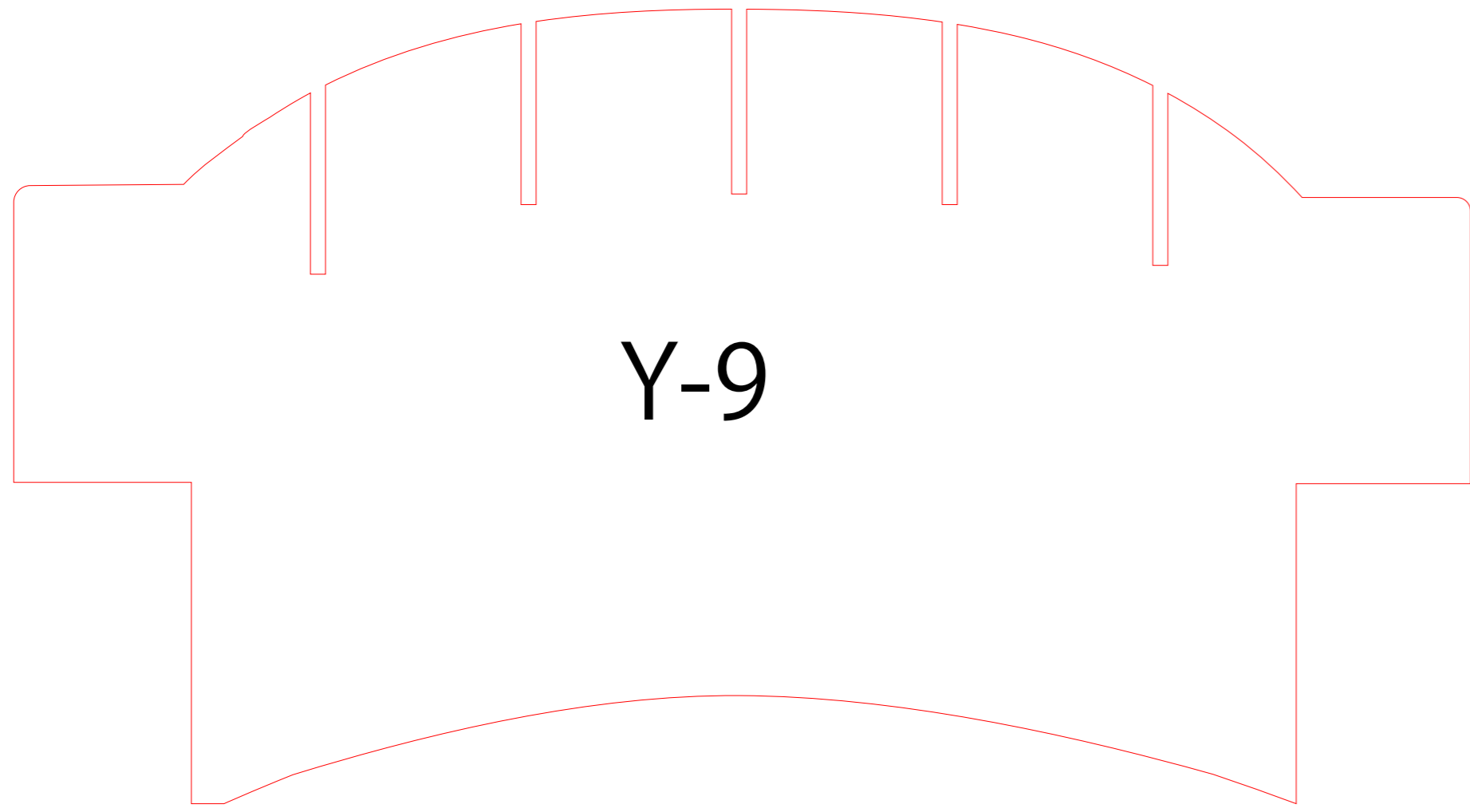

Y-9

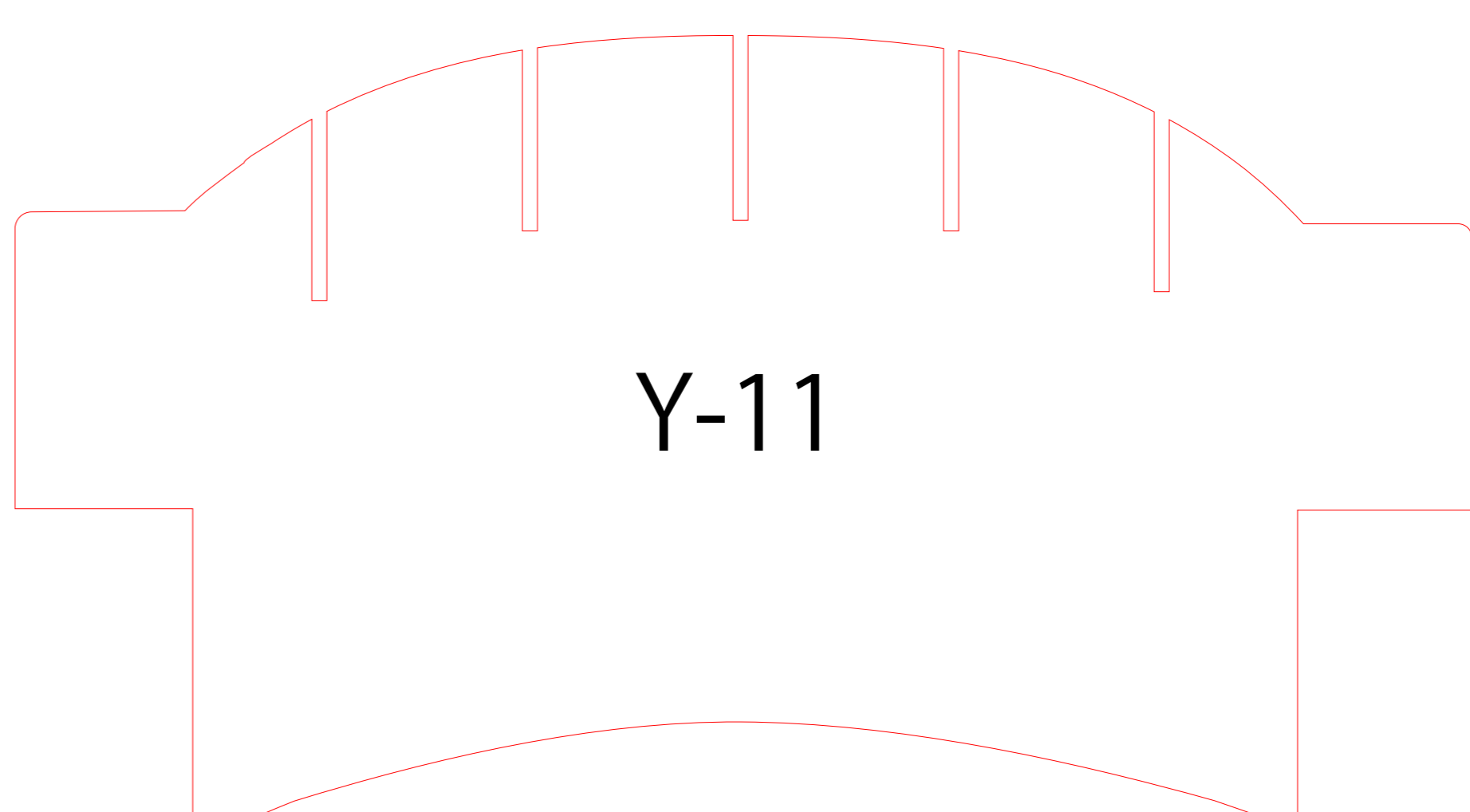

Y-11

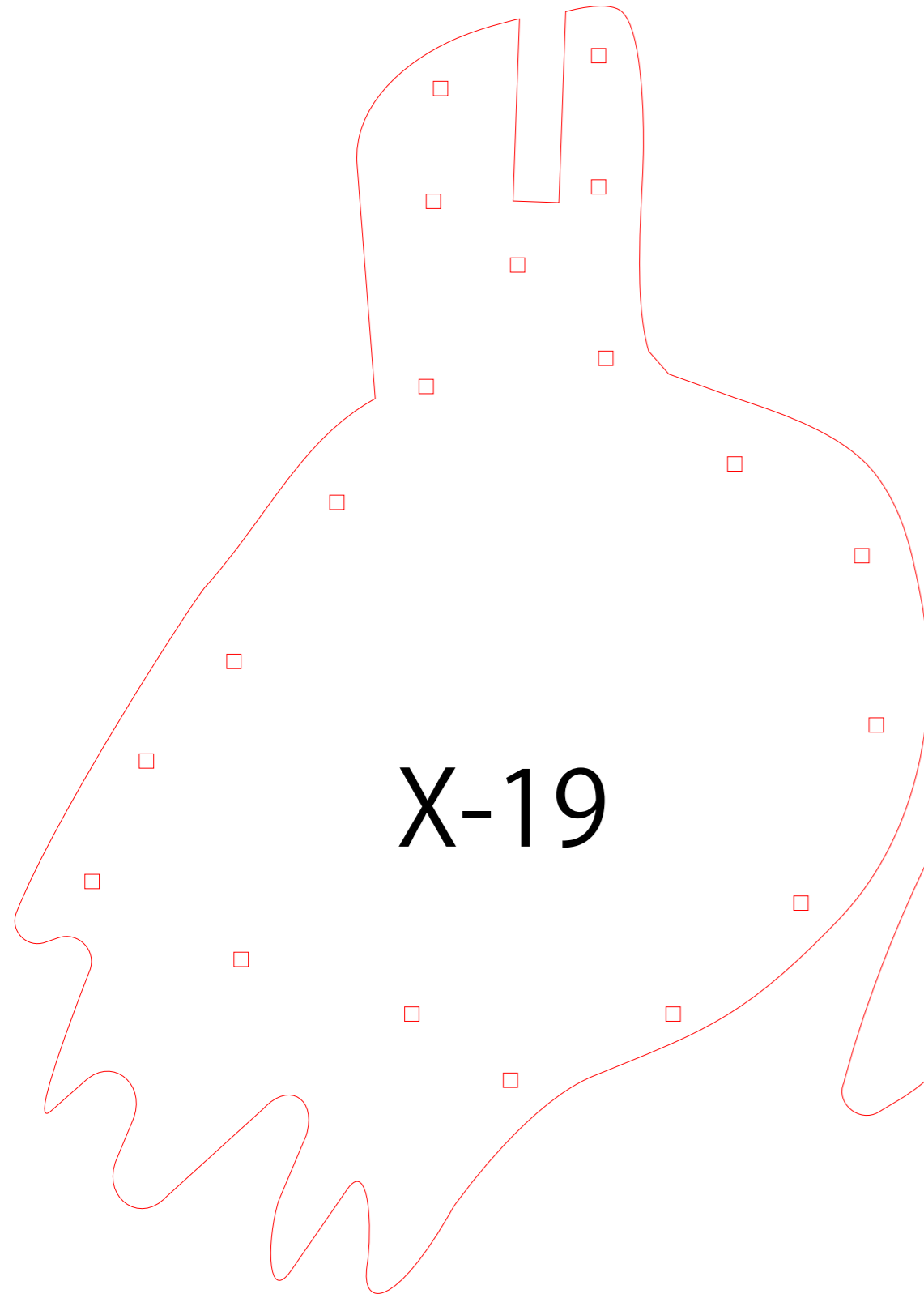
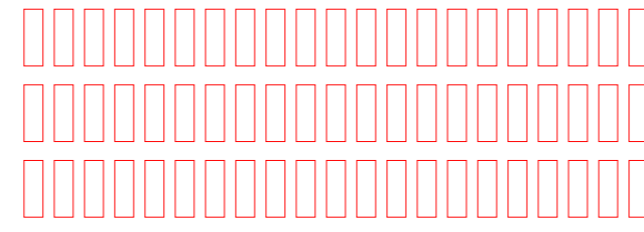
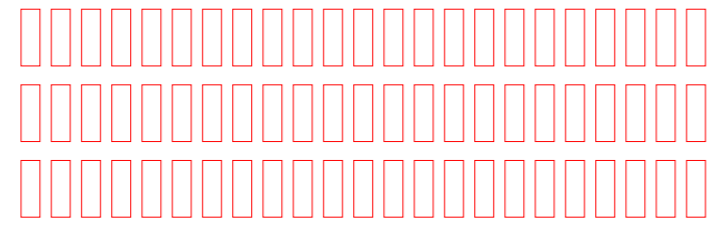

X-19

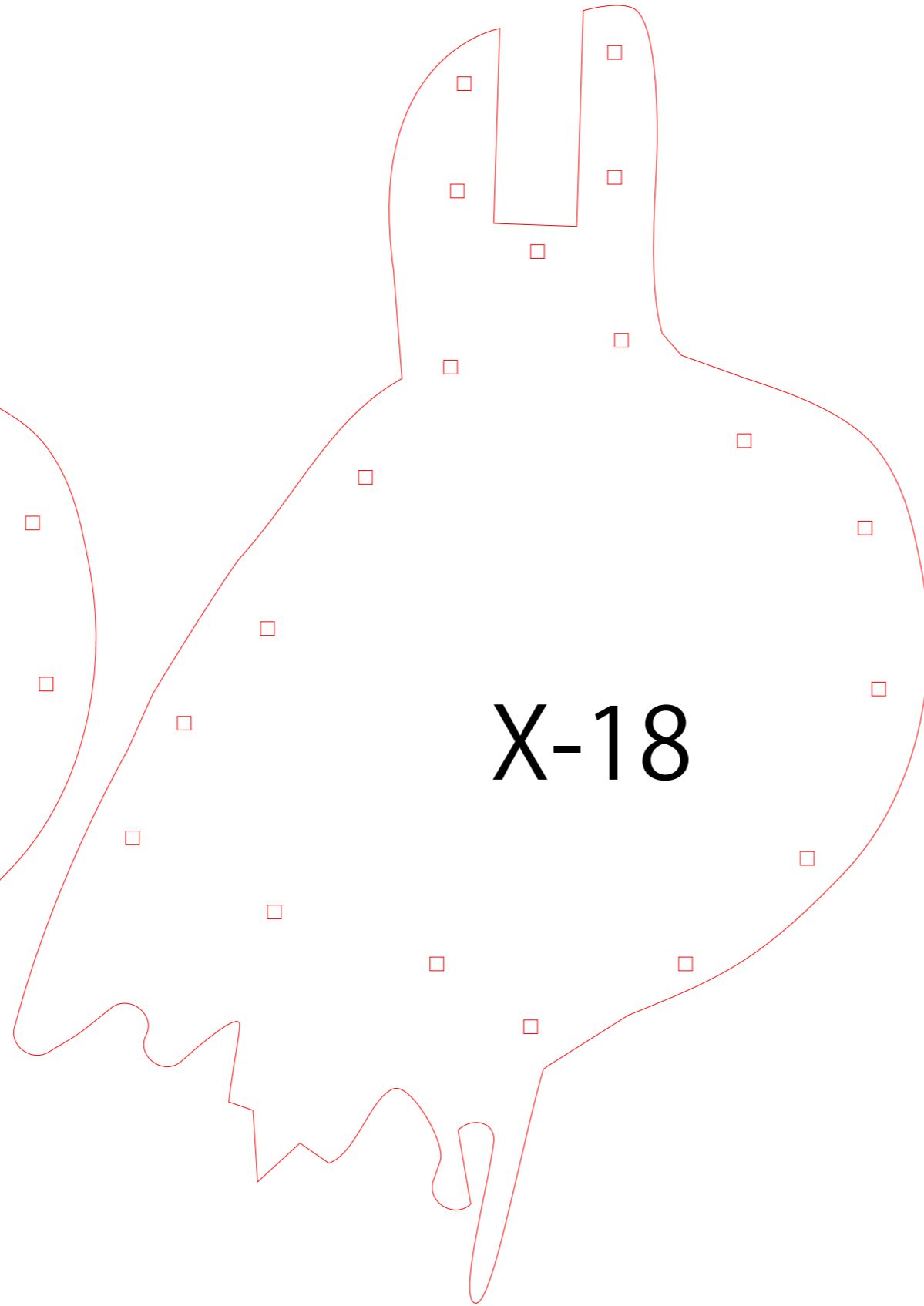

X-18

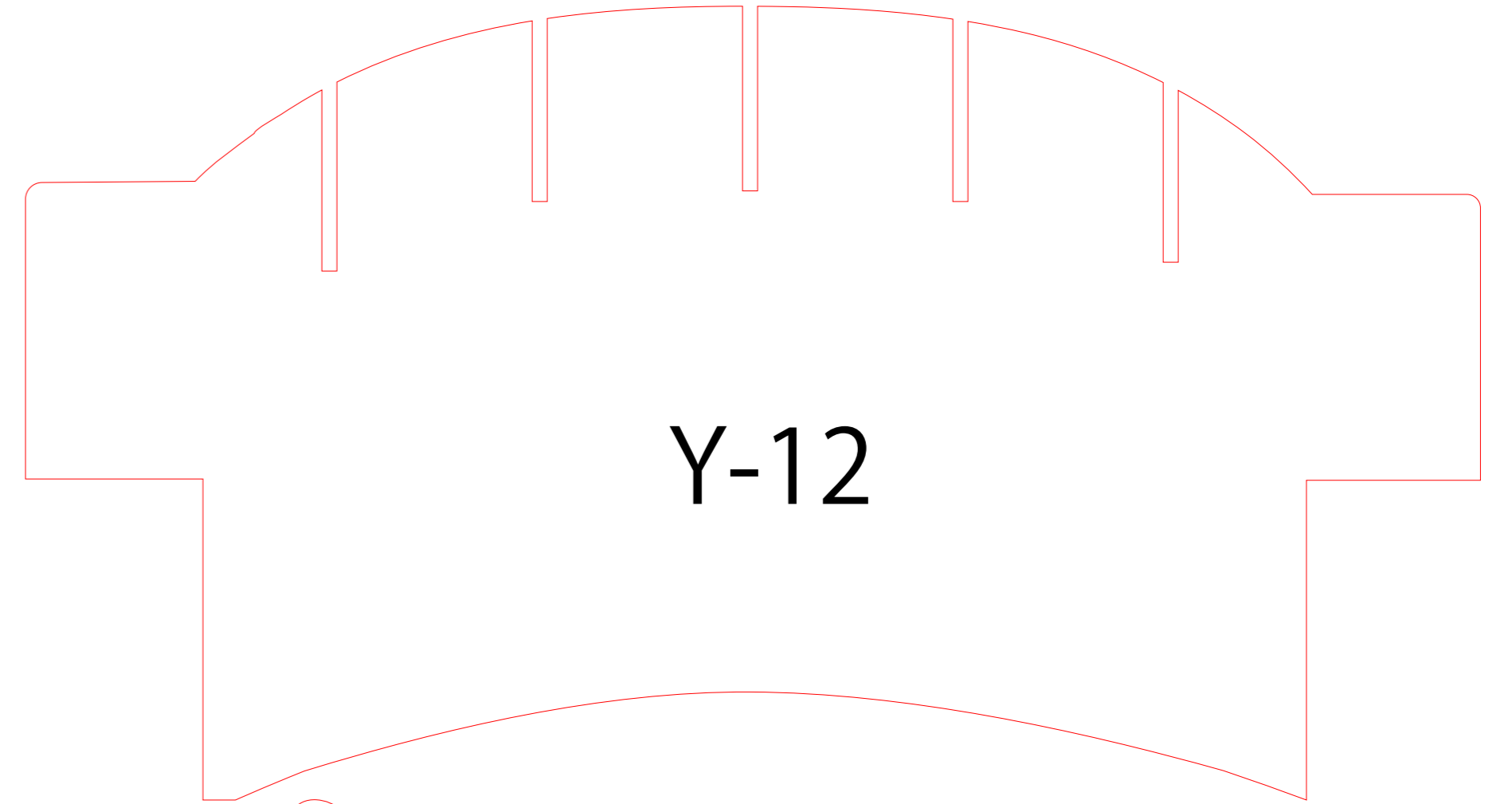

Y-12

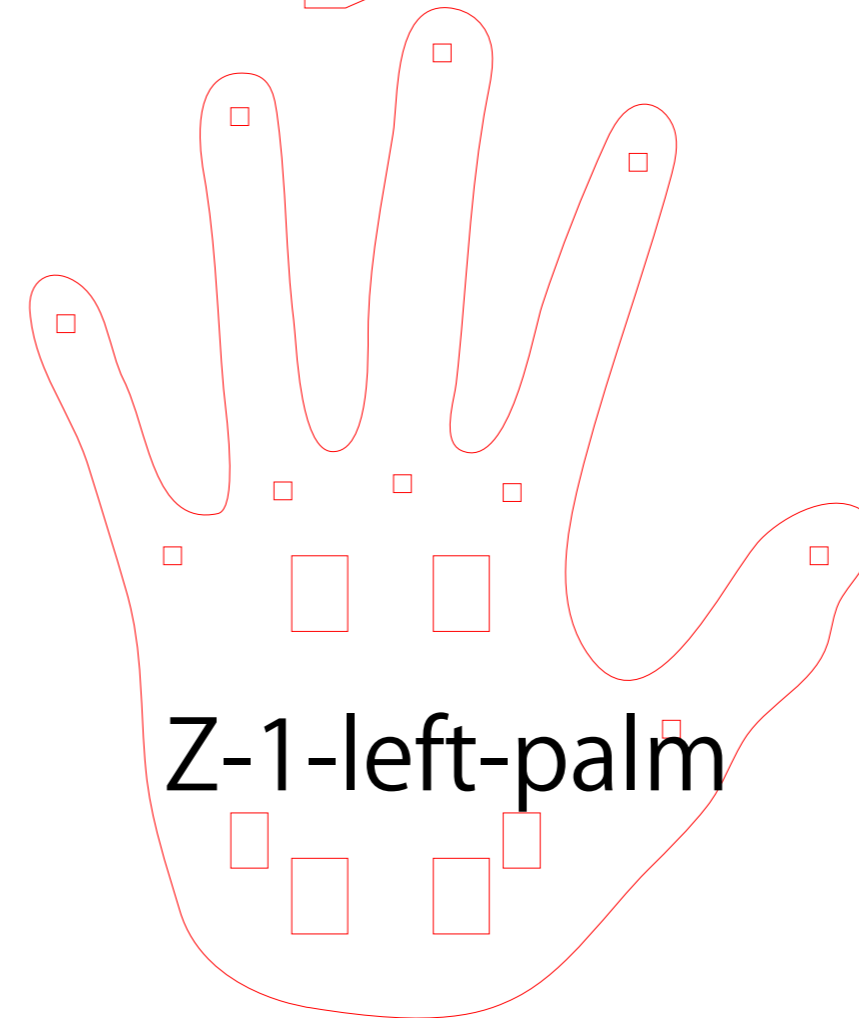

Z-1-left-palm



Z-1-rihgt-palm

