

BASE WITH MAGNET MOUNT E'BORES

DWG-A

PER

DIMS IN INCHES
 MAT'L: 1/2 PLYWOOD

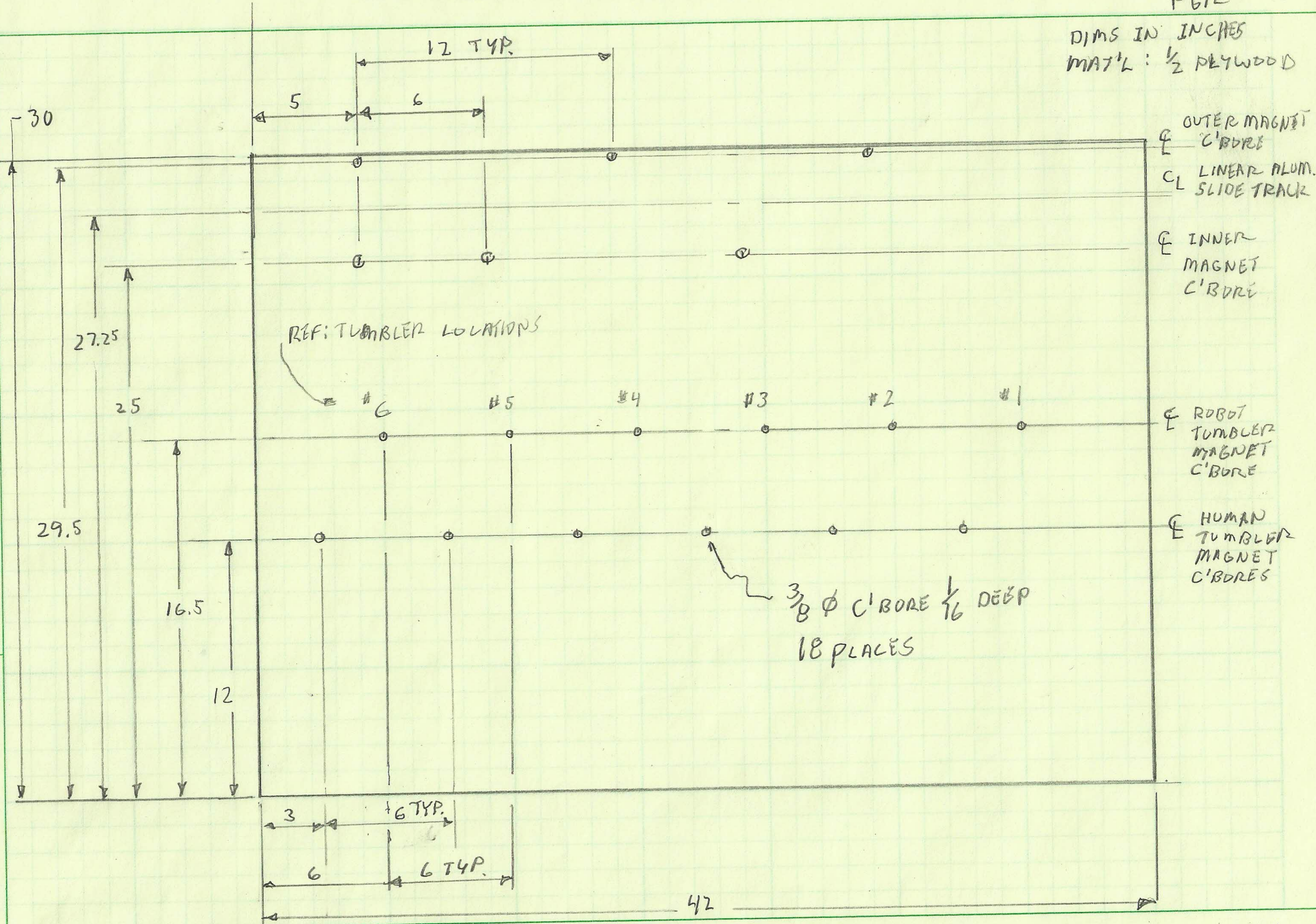

IDLER SPROCKET BRACKET

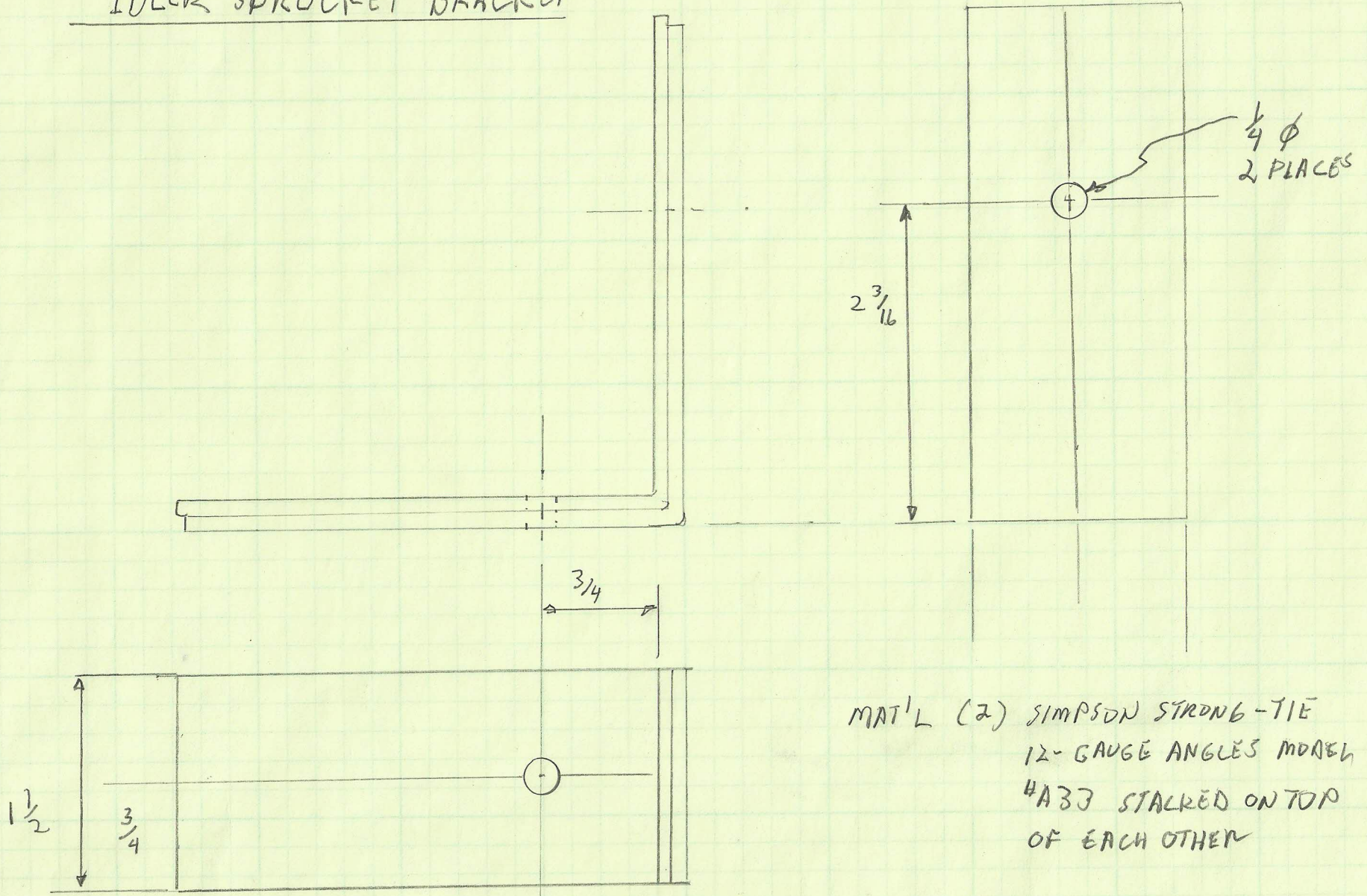

IDLER SPROCKET SIDE PLATE

PGR

DIM IN INCHES

2 REQ'D

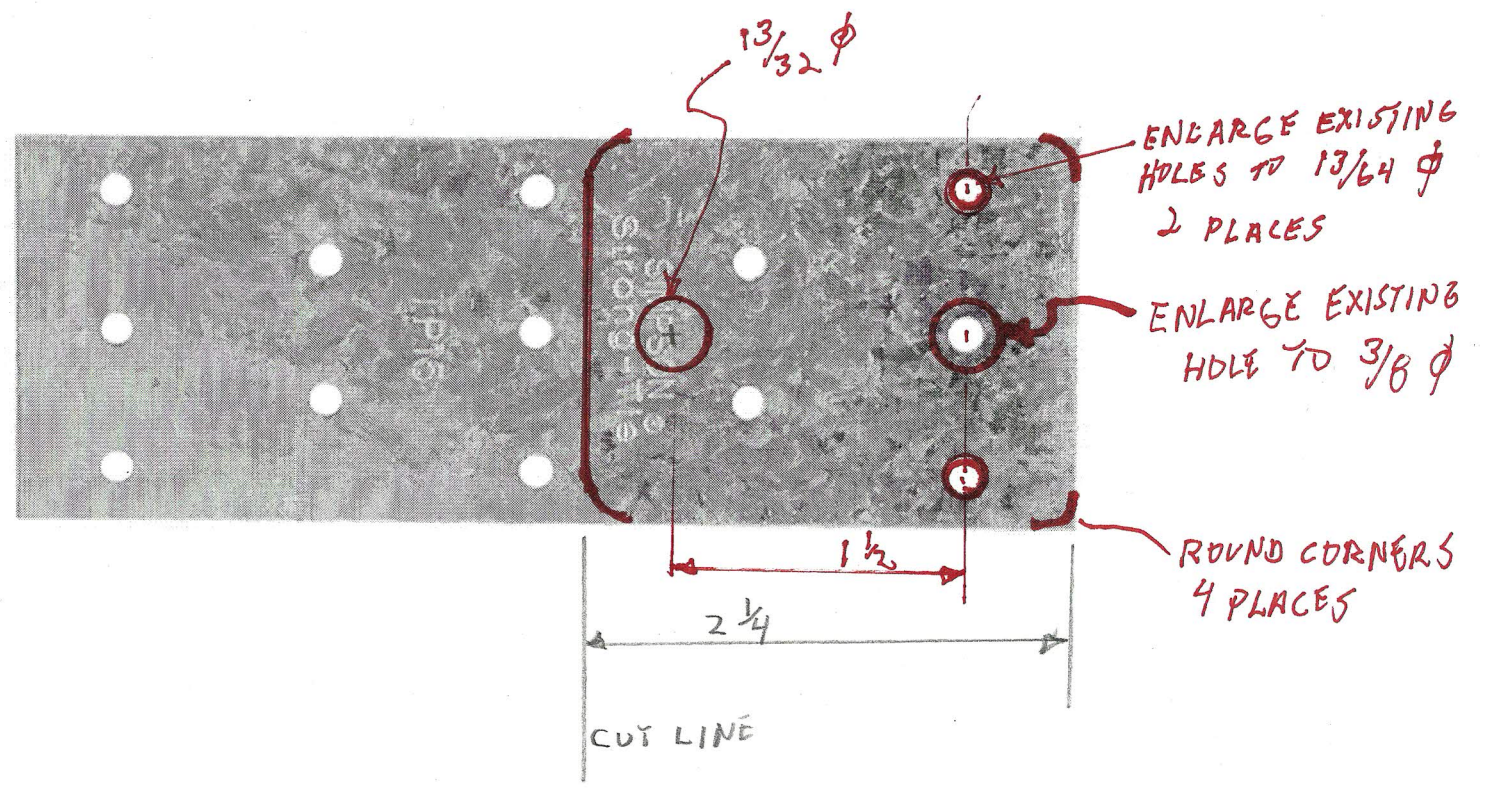

MAKE FROM: SIMPSON STRONG-TIE
 $1 \frac{13}{16} \times 5$ IN. TIE PLATE
 TP15

MOUNTING BLOCK

MAT'L: 1 3/4 SQ
DELRI N BAR
STOCK

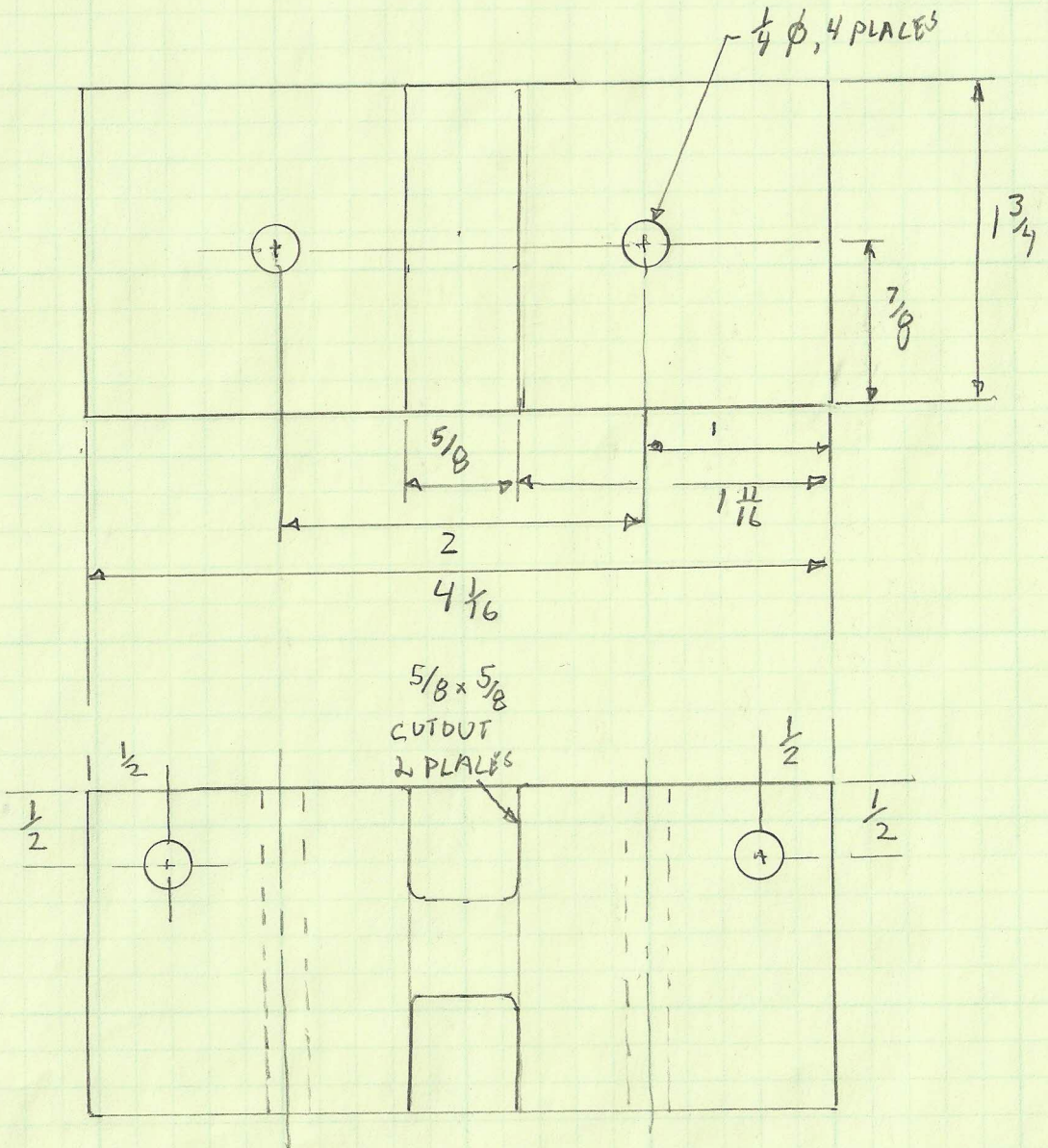

0891

DWG - E

P6R

DIM IN INCHES

DRIVE CHAIN ANCHOR & CABLE GUARD

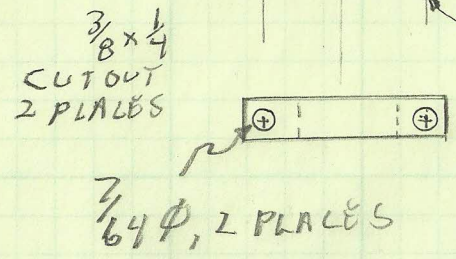
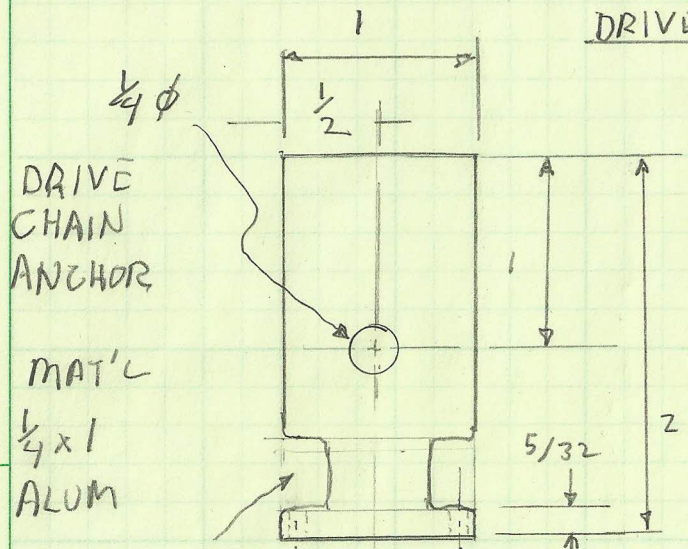

MASTER LINKS
INSTALL IN
THESE TWO HOLES
CREATES CONNECTION
TO DRIVE CHAIN

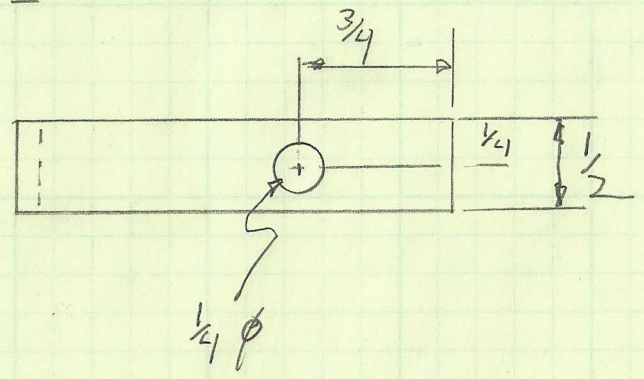
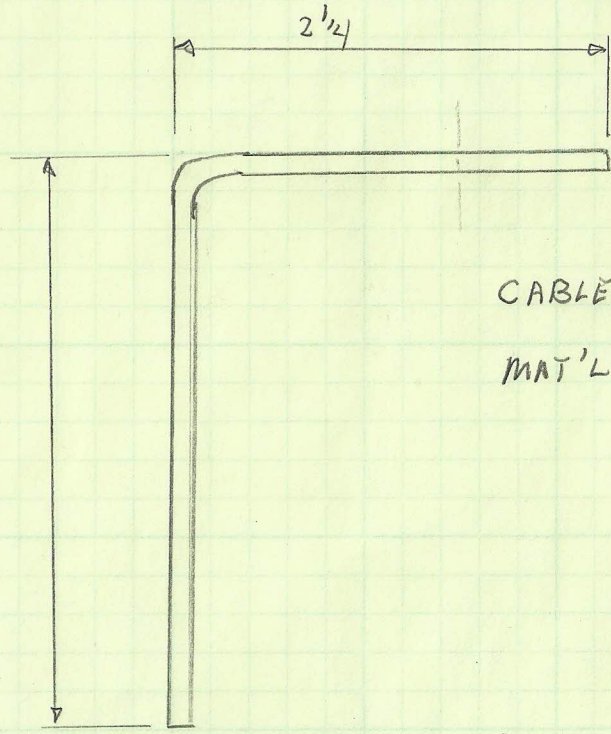

PVC PIPE CUT-OFFS

MAT'L: 1/2" PVC PIPE
DIMS IN INCHES

TOP VIEW

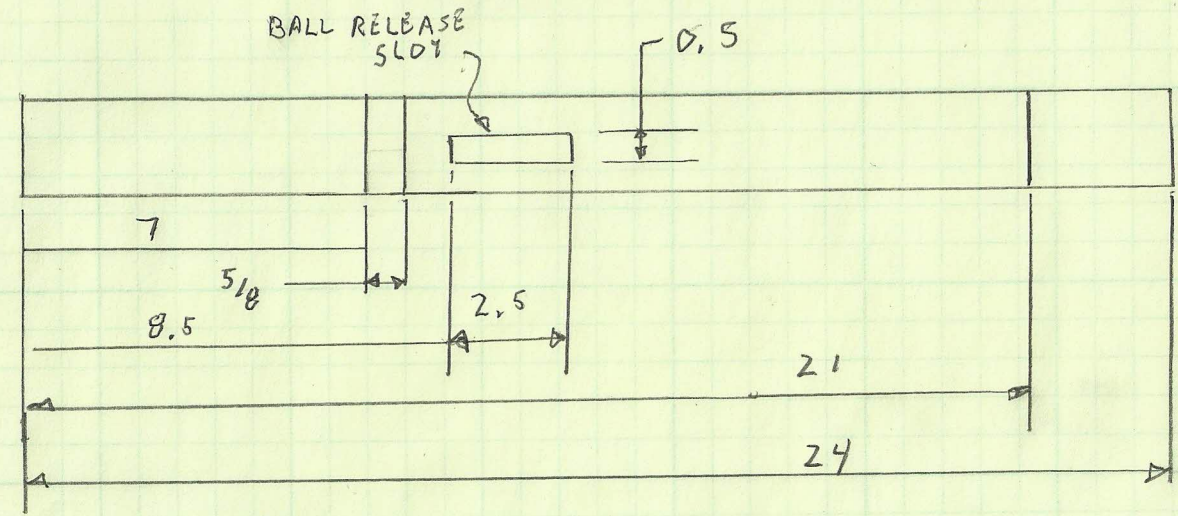

SIDE VIEW CUTAWAY

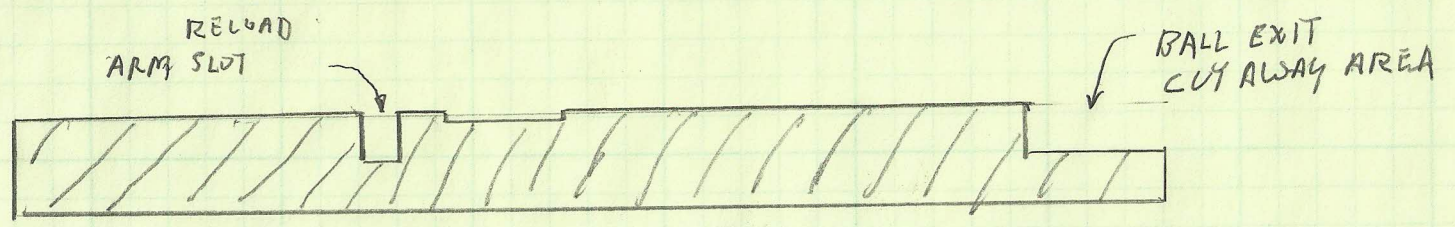

SERVOD MOUNTING PLATES

MAT'L: 1/16 THK ALUM
OR STEEL

DIM. IN INCHES

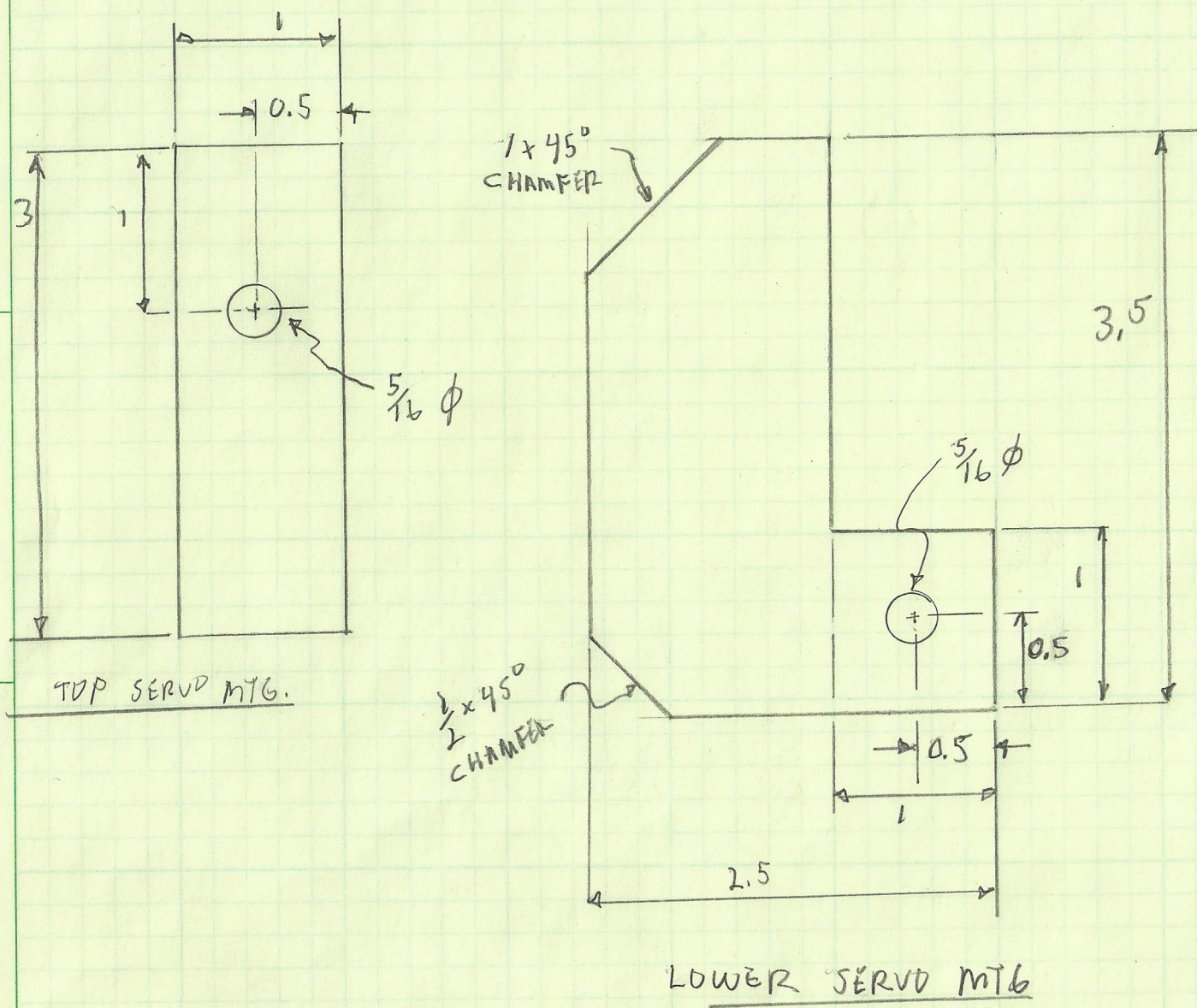

SUPPORT ARMS - PVC PIPE

PBR
MAT'L: 1/4 x 1 ALUM
BAR STOCK
DIM. IN INCHES

OUTER SUPPORT ARM

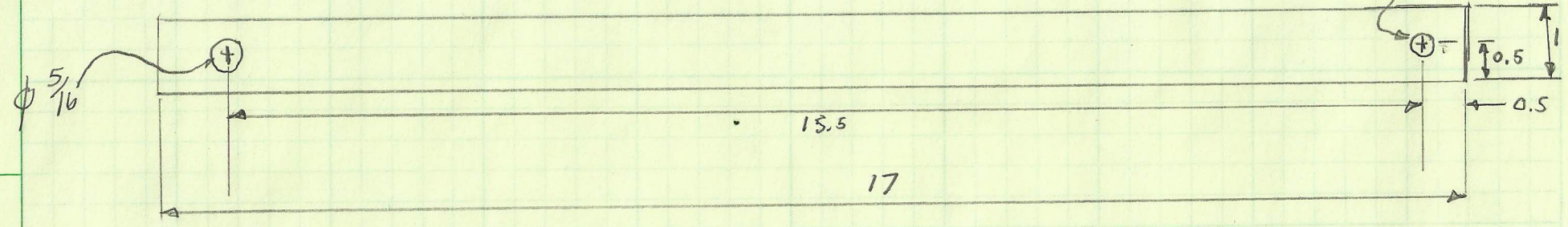

INNER SUPPORT ARM

