

<https://www.instructables.com/Perennial-Gingerbread-House/>

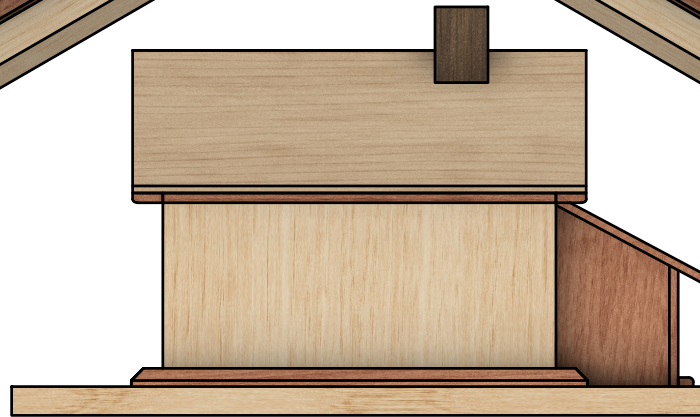

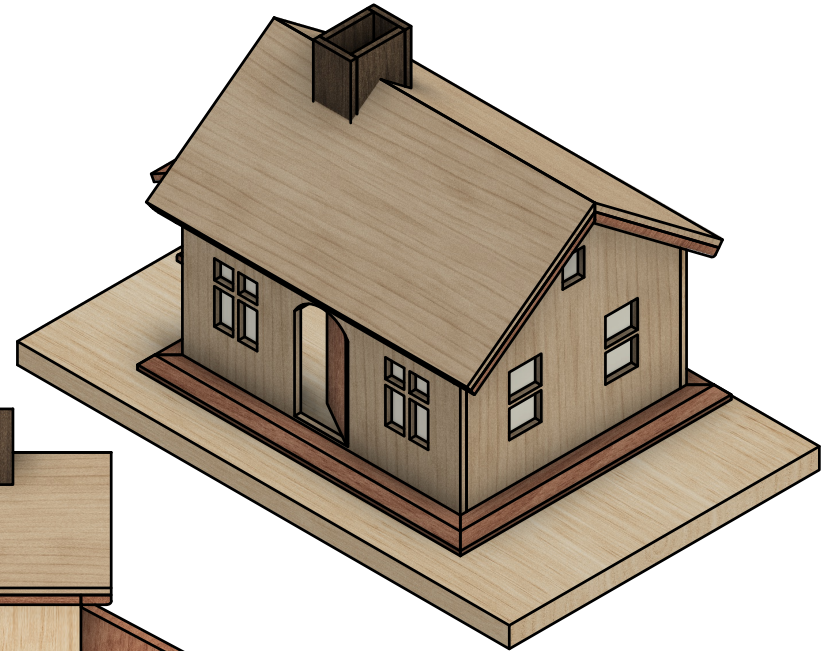
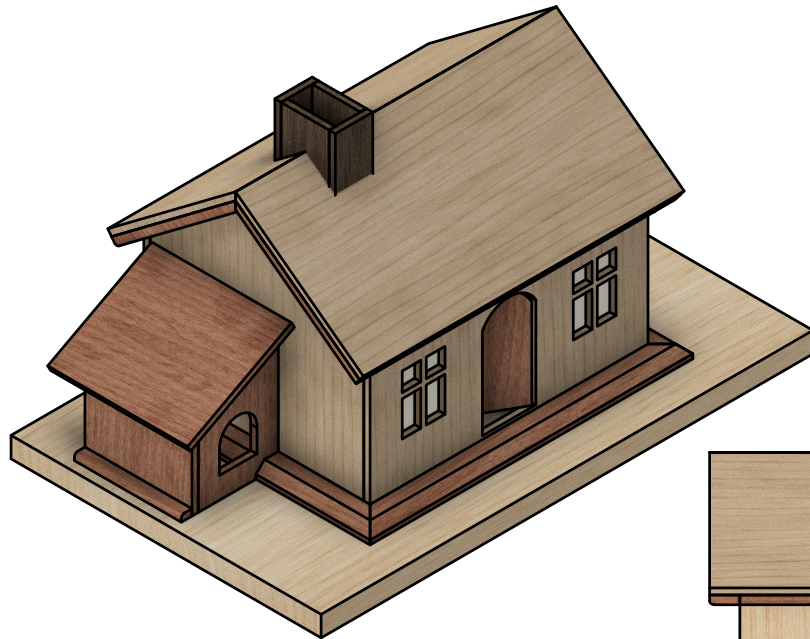
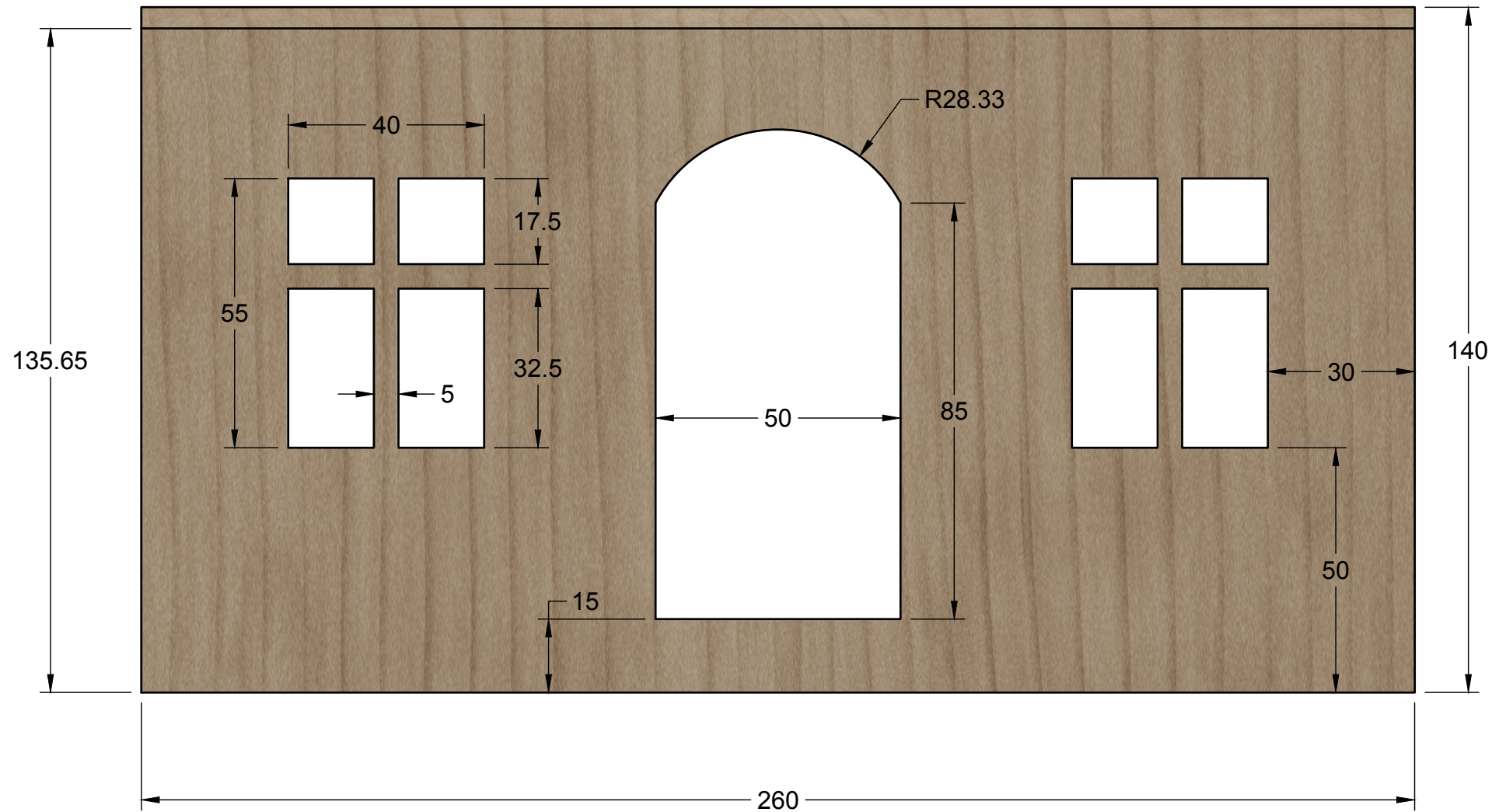

All dimensions in this PDF are in mm
 Construction with $\frac{1}{4}$ " (5.8mm) plywood

Front

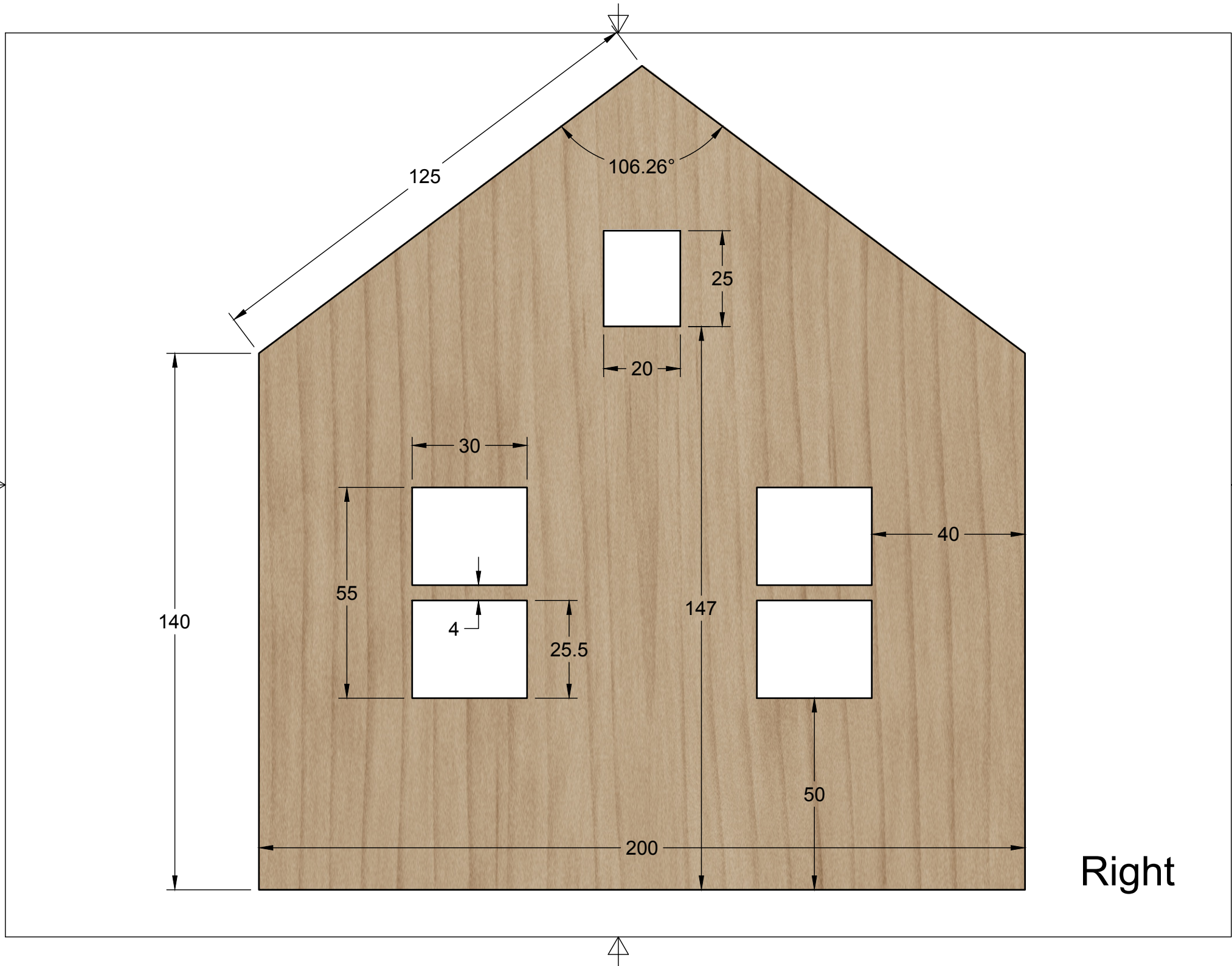



140

260

Back

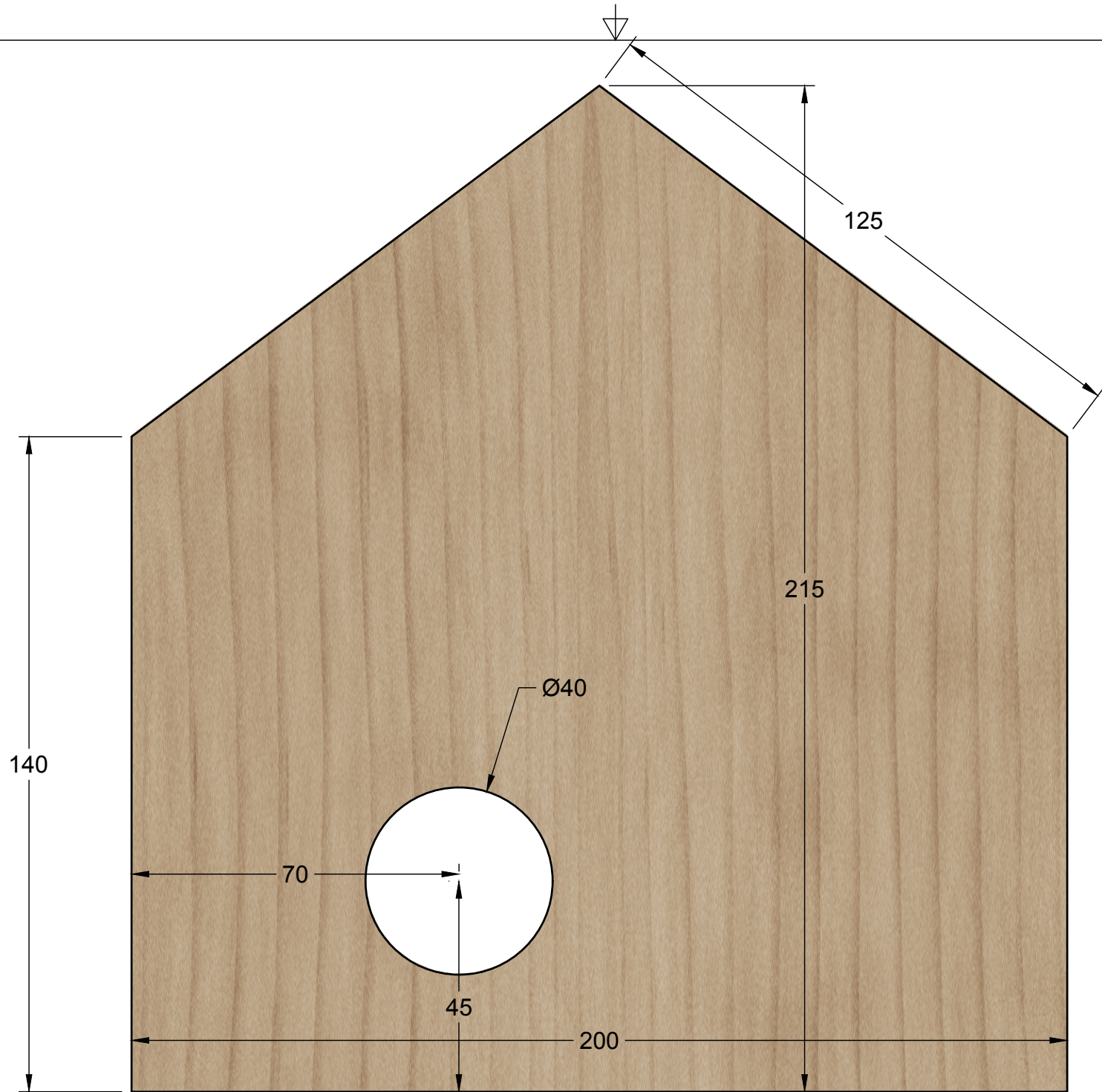

Left

53.13°

5.8

149.35

300

Roof (Front/Back)

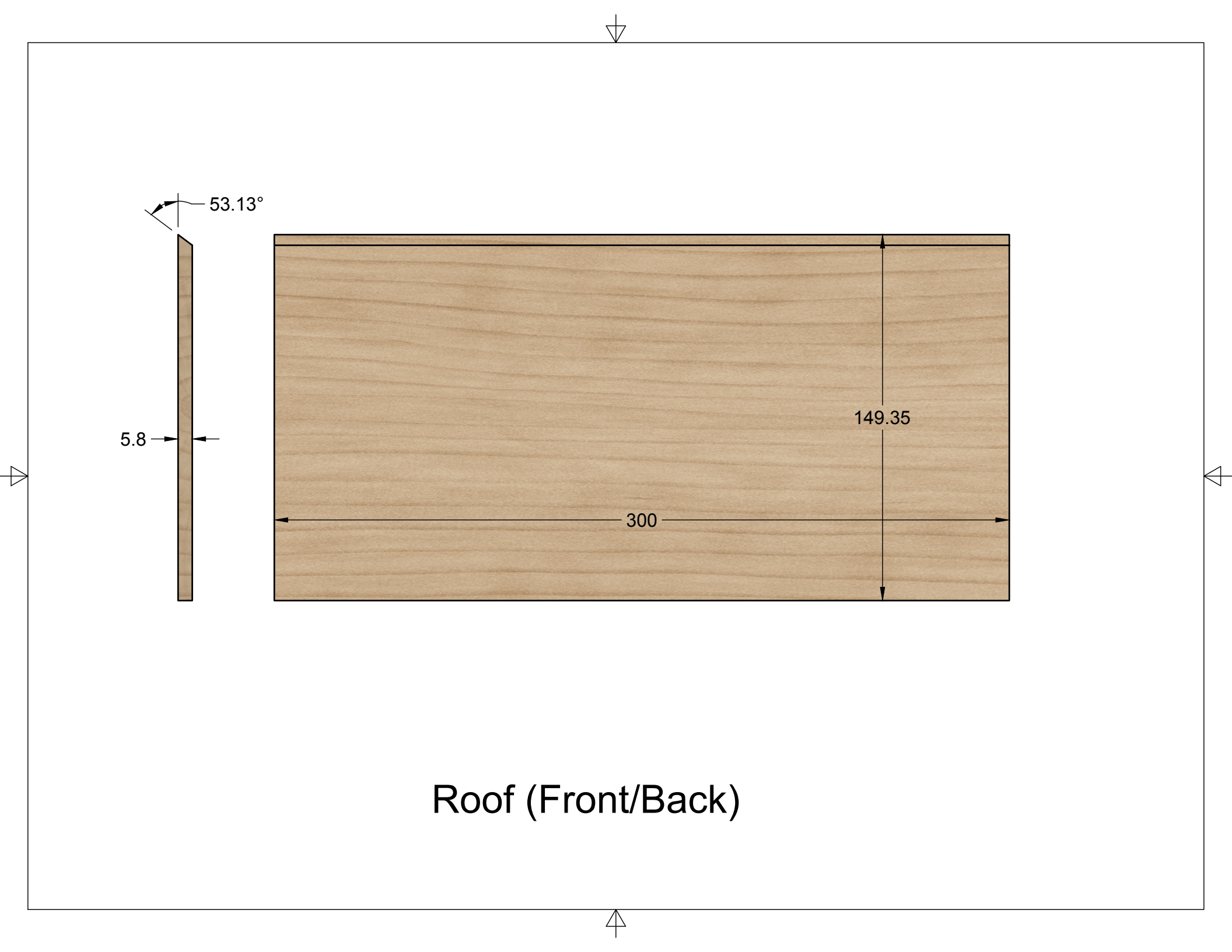

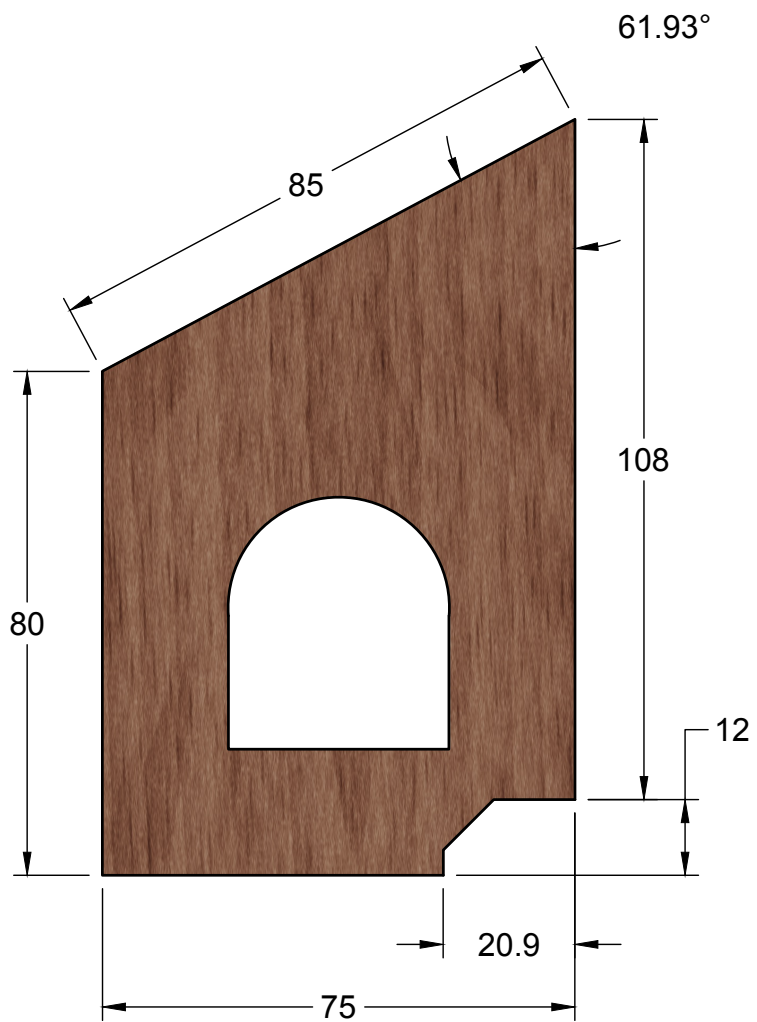

Shed Front

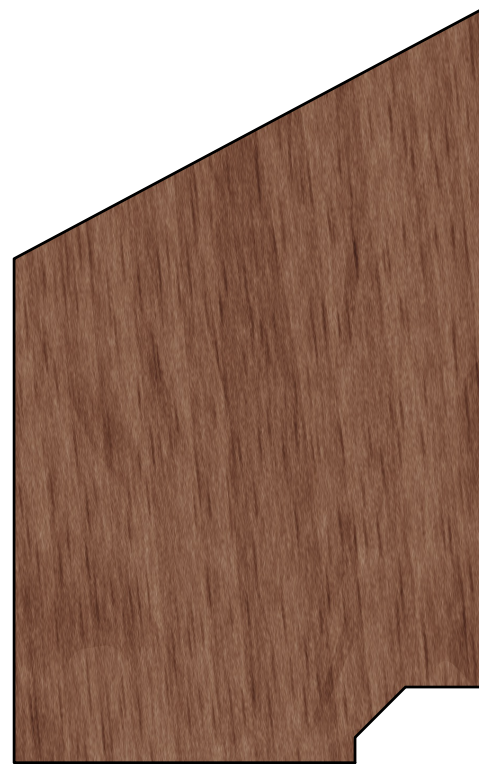

Shed Back

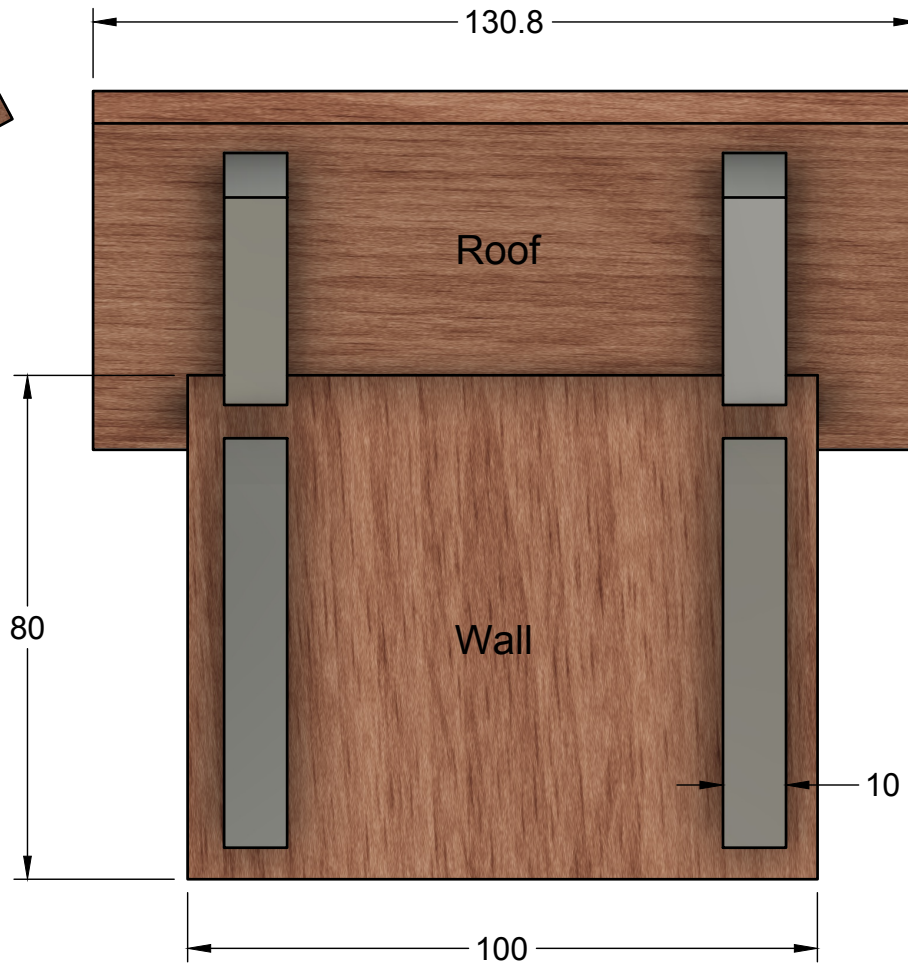
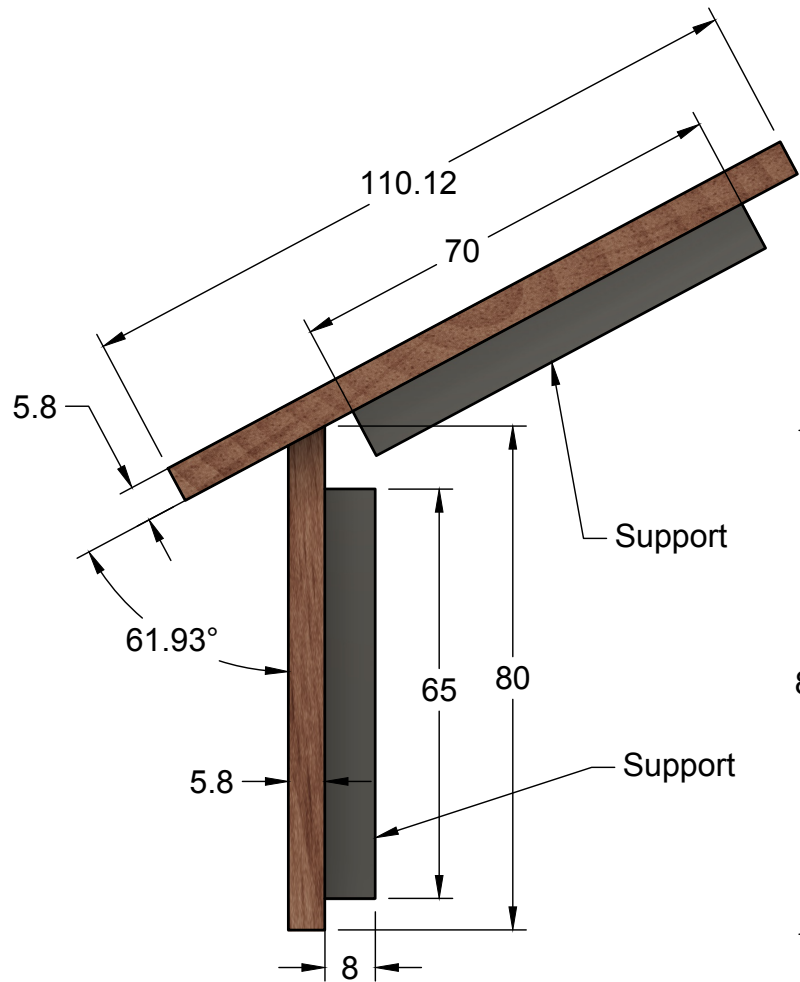

Shed Roof & Wall



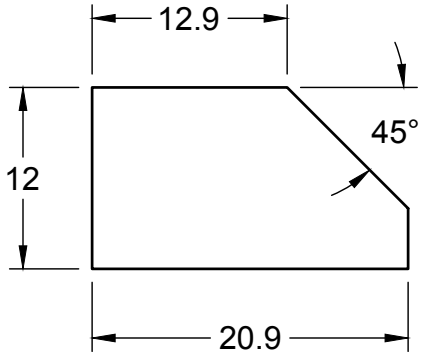
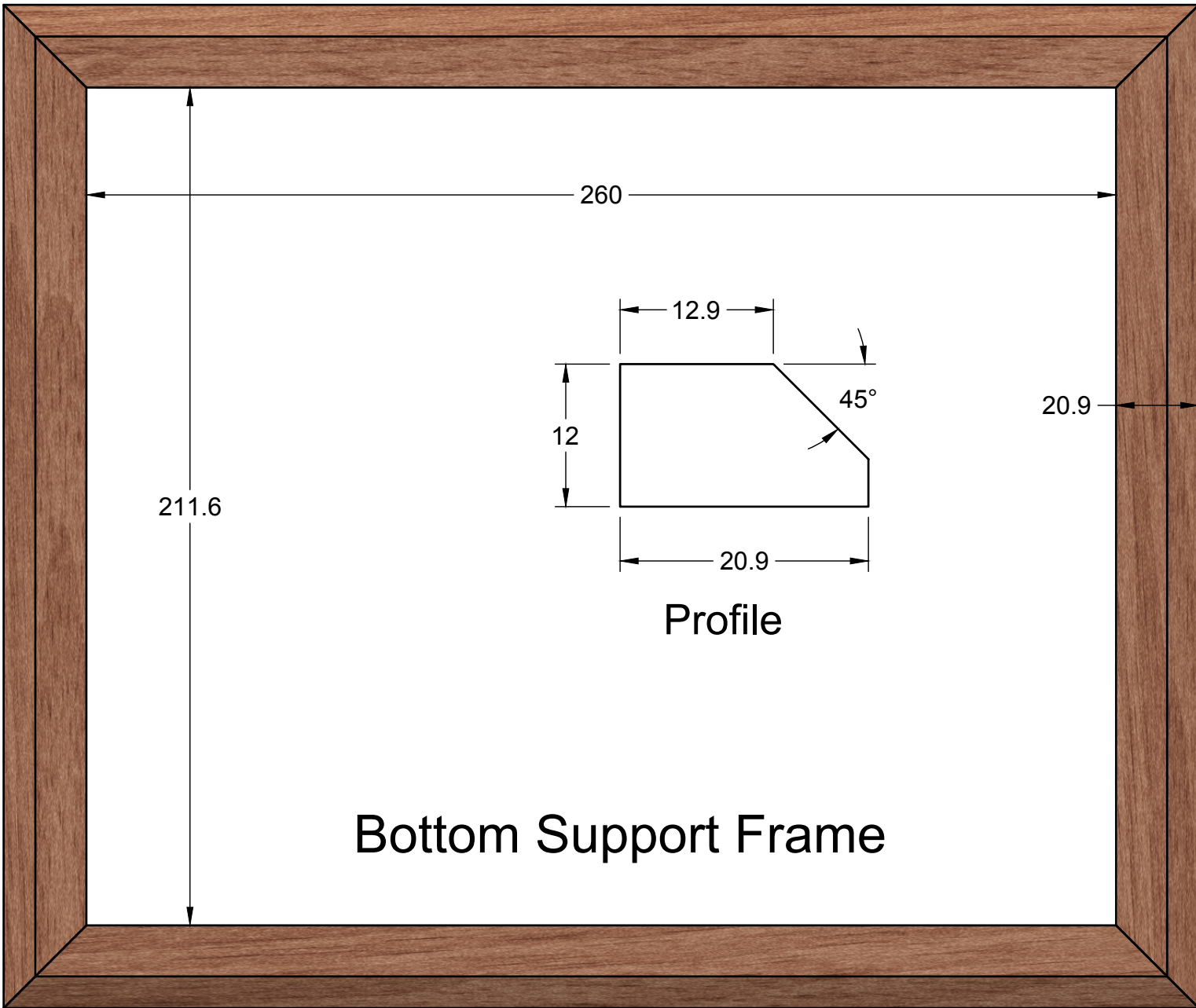

Profile

Bottom Support Frame

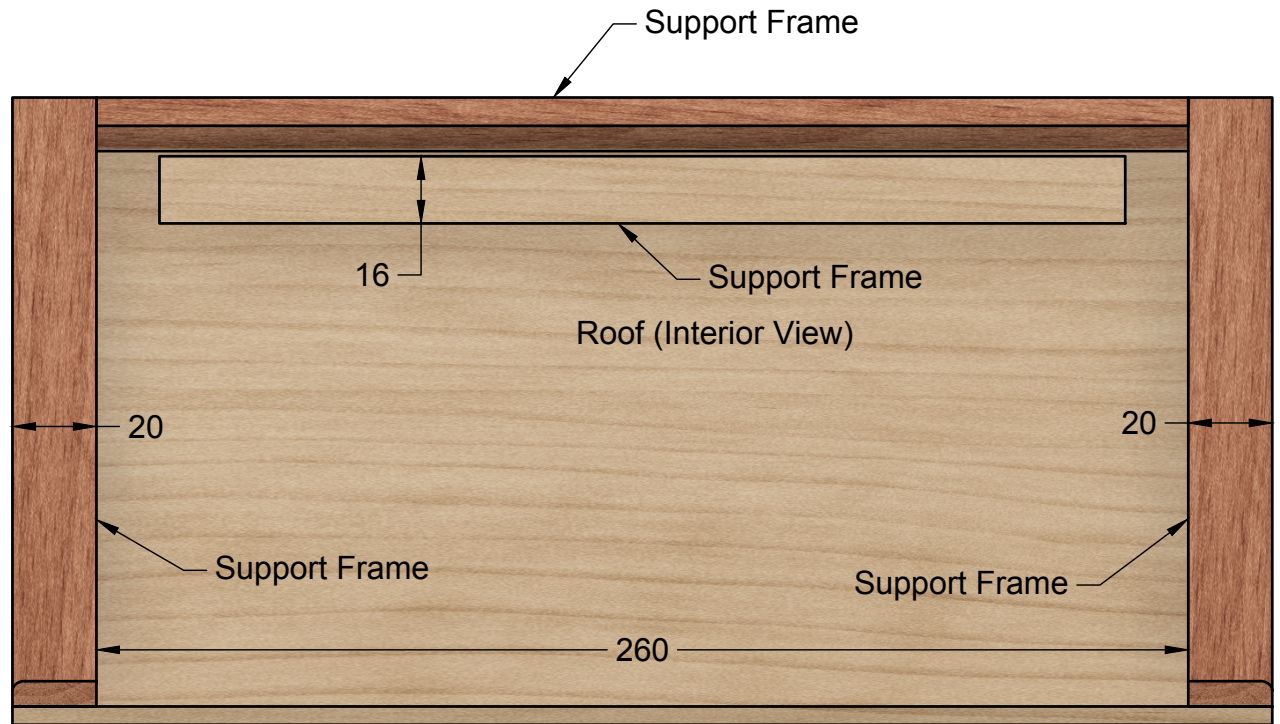
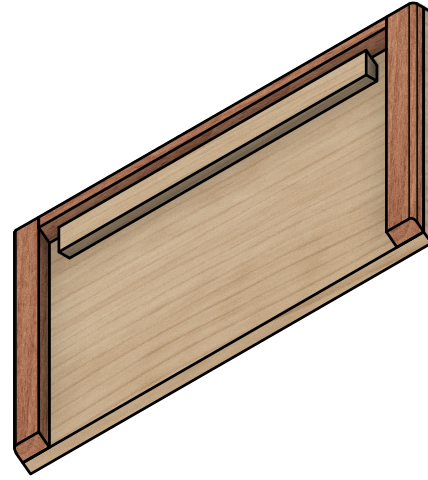
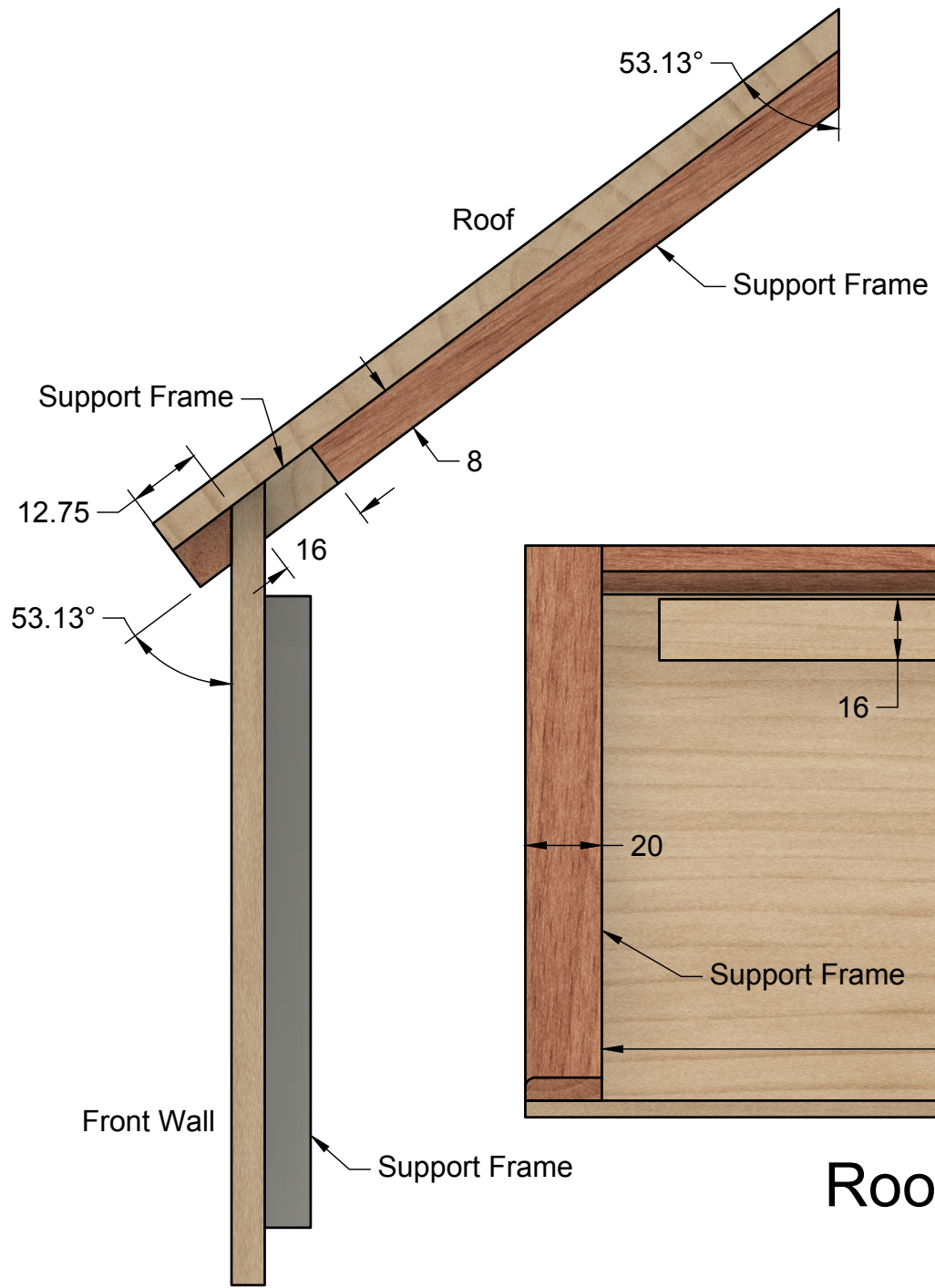

Roof (Interior View)



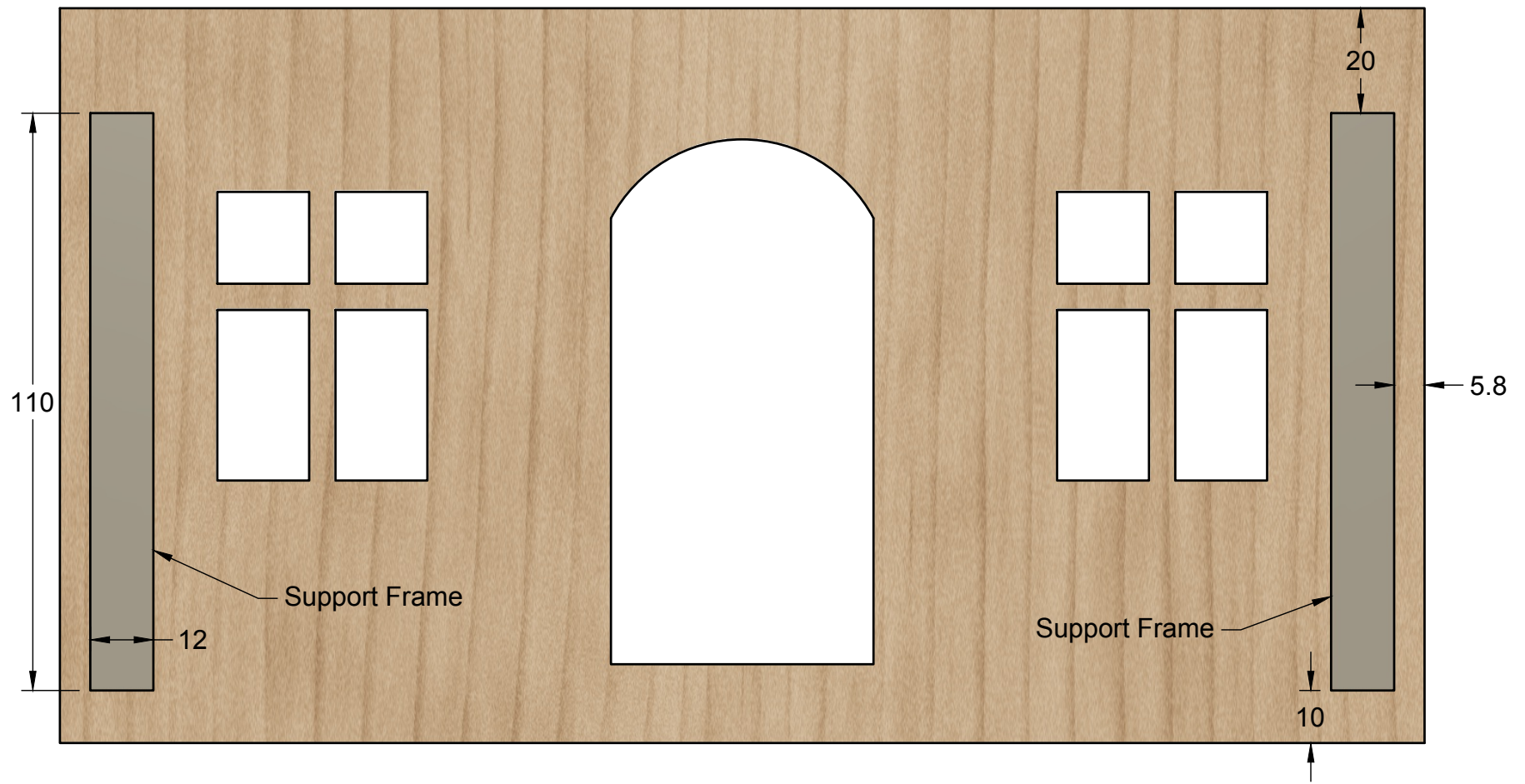

Front Wall (Interior View)

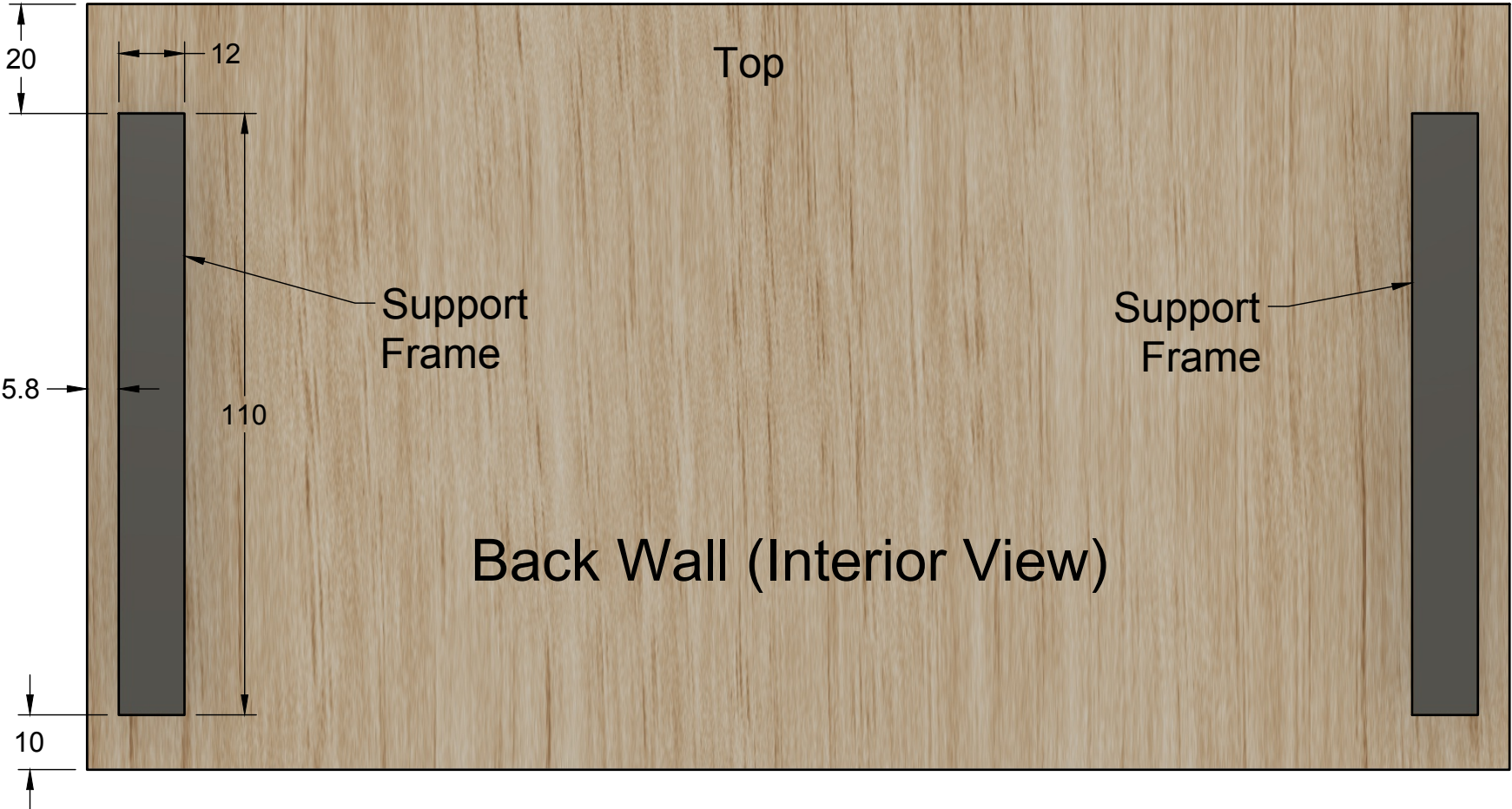

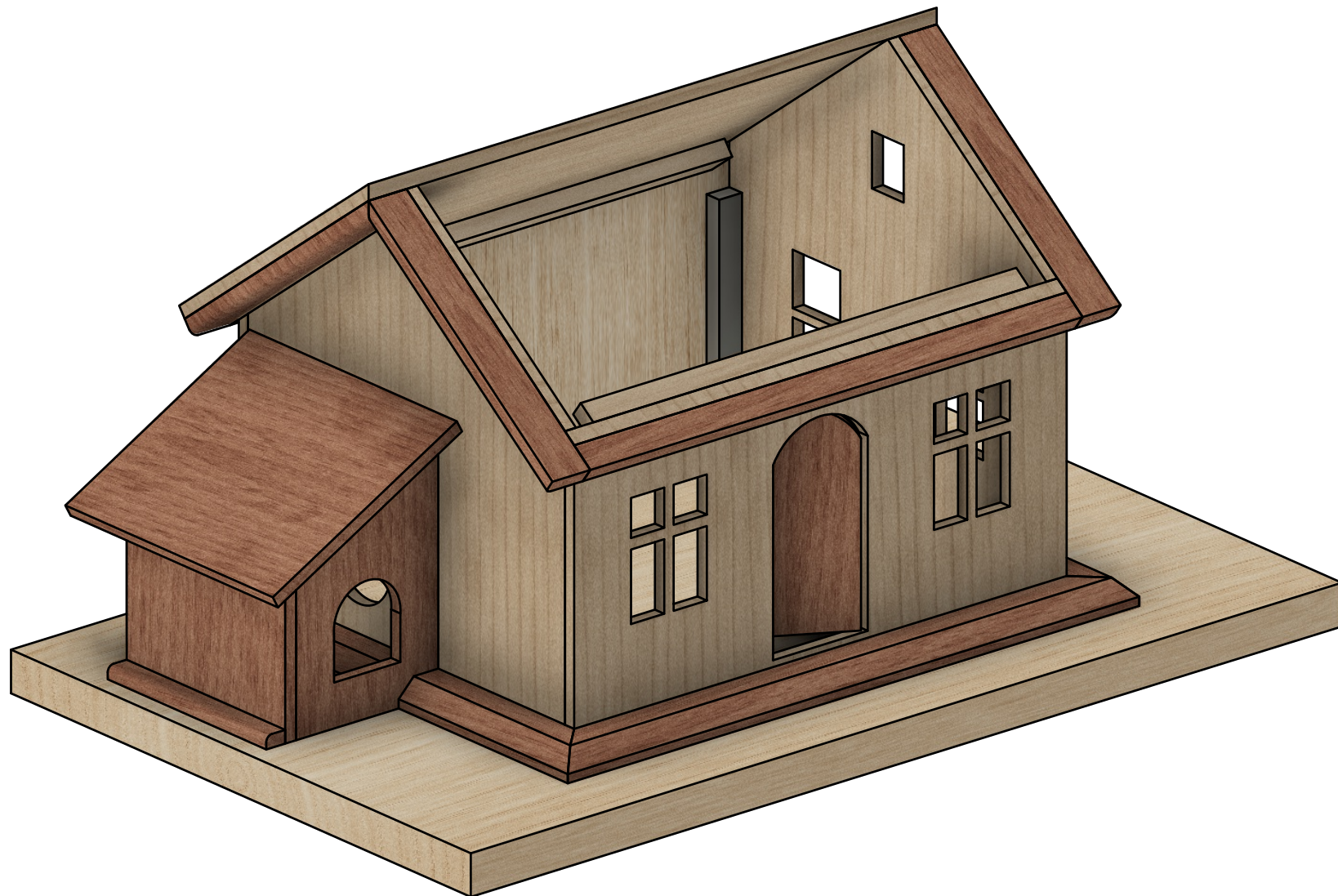

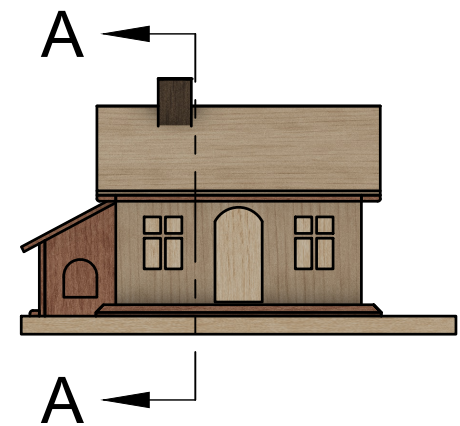
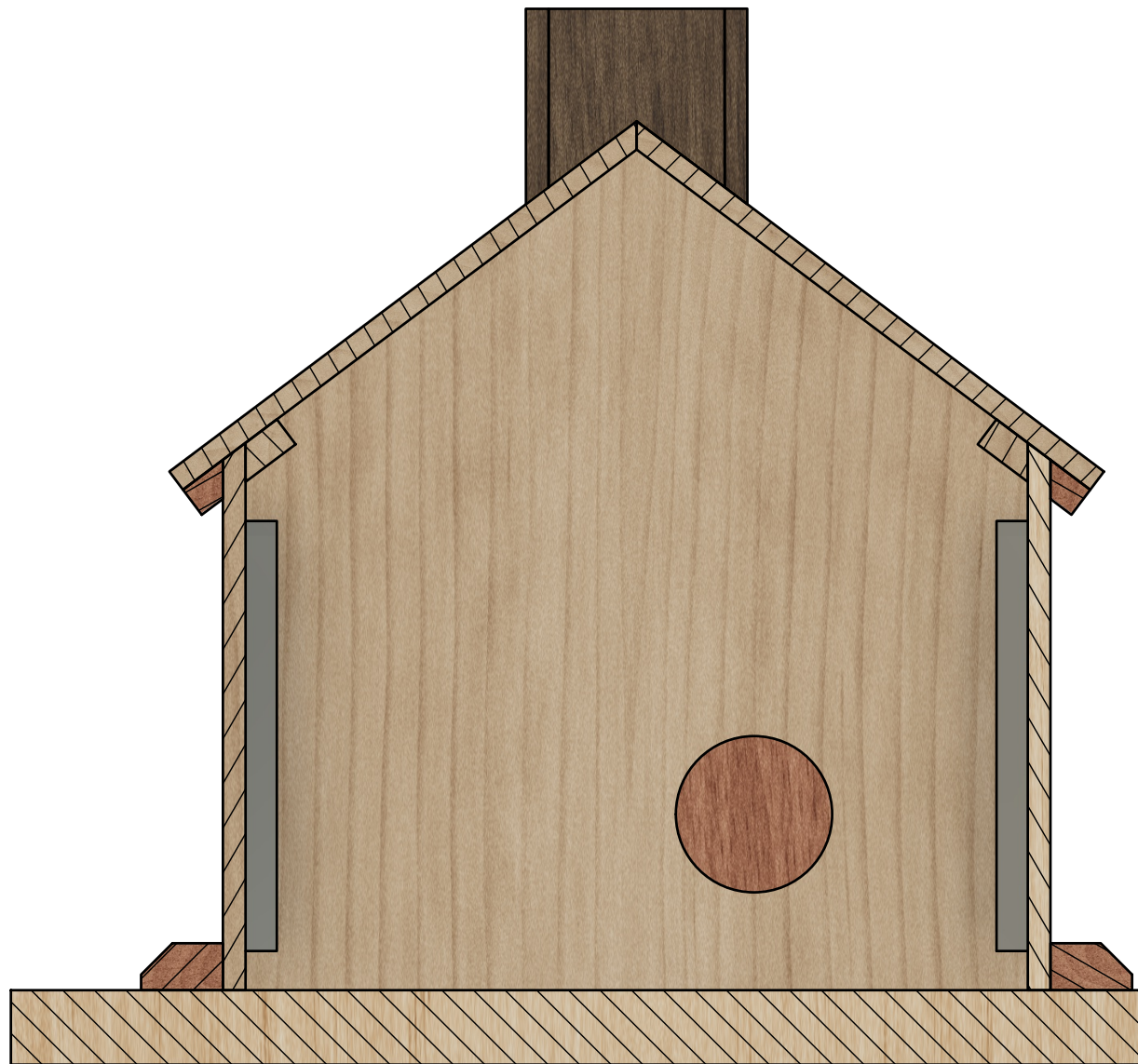

SECTION A-A
SCALE 1:1.8

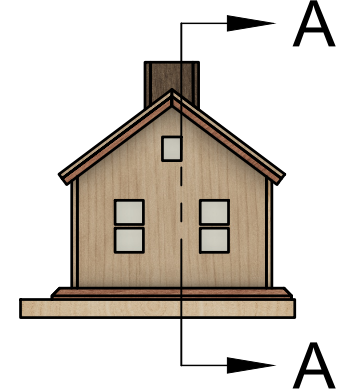
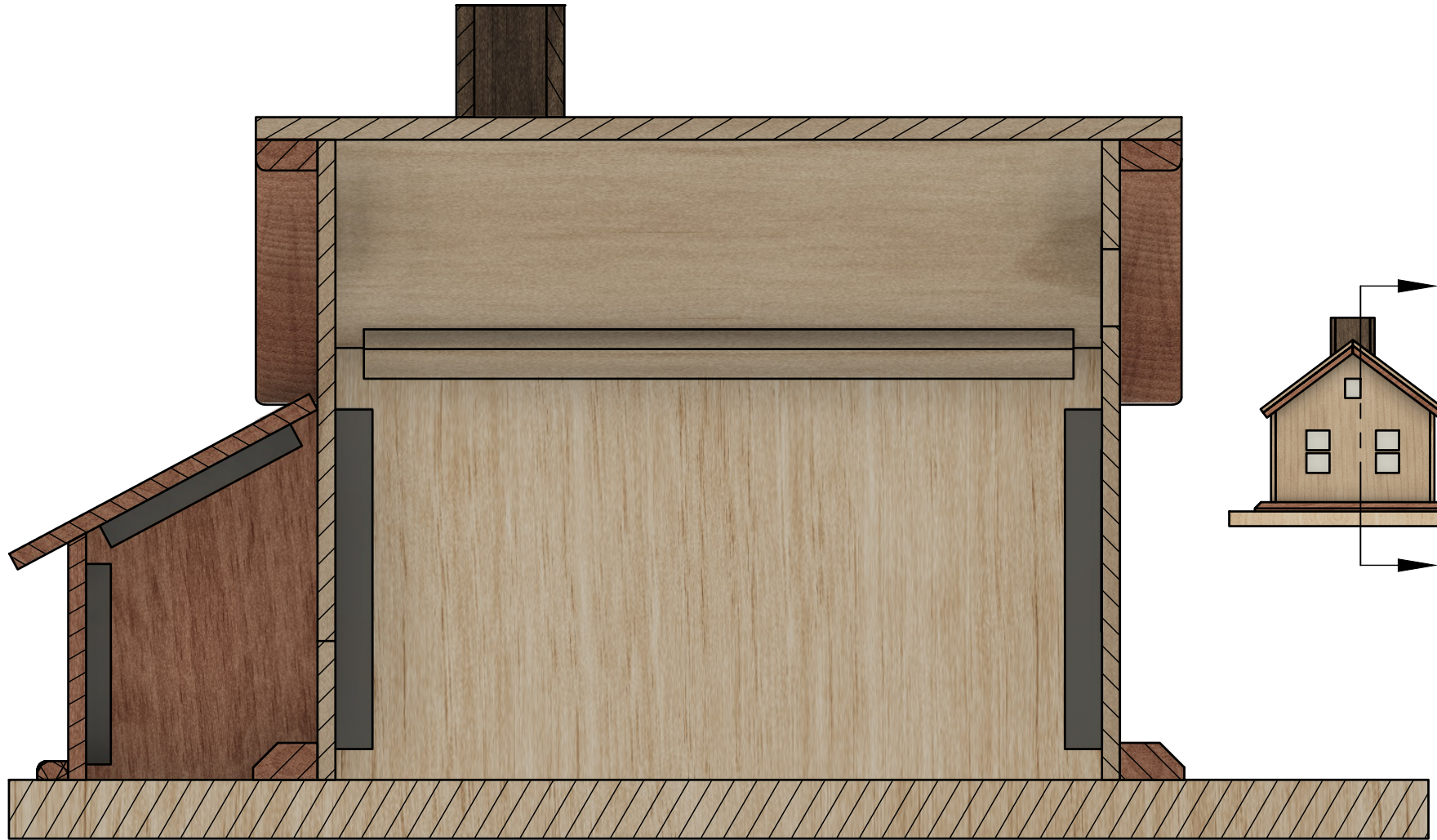

SECTION A-A
SCALE 1:2

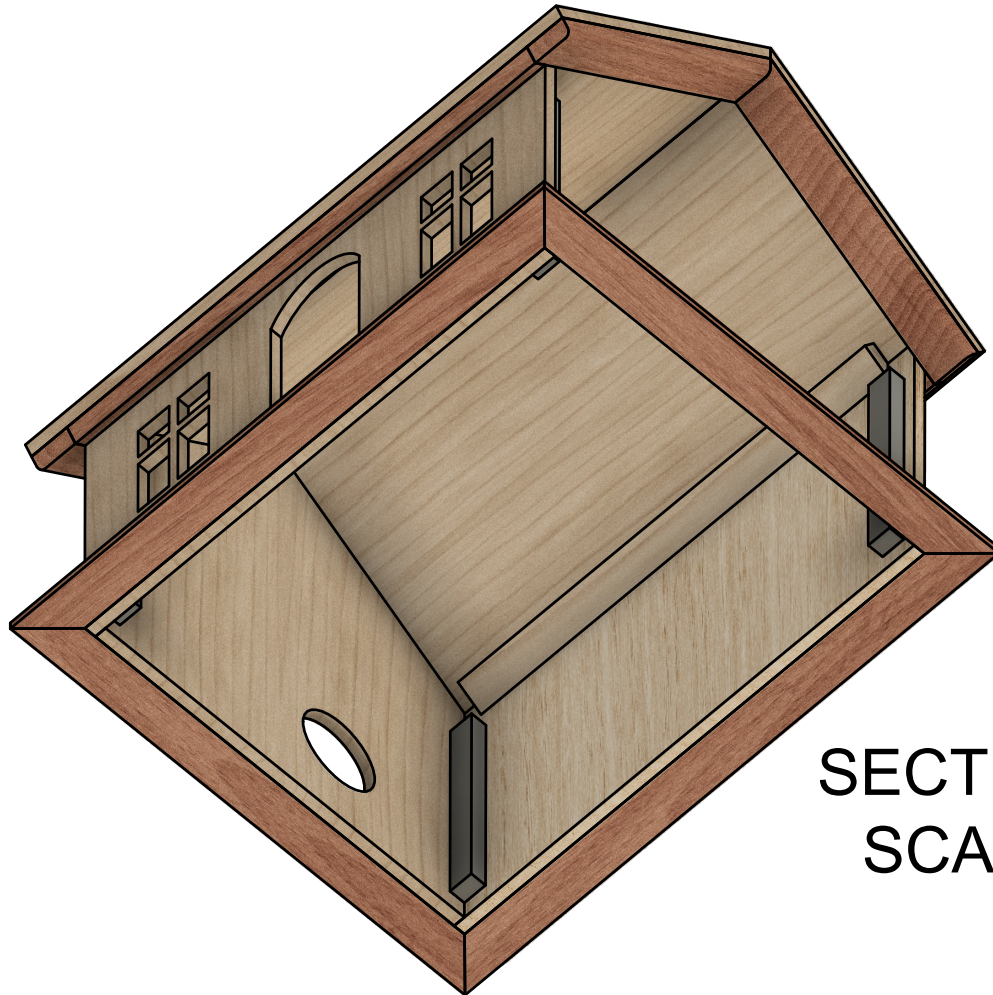
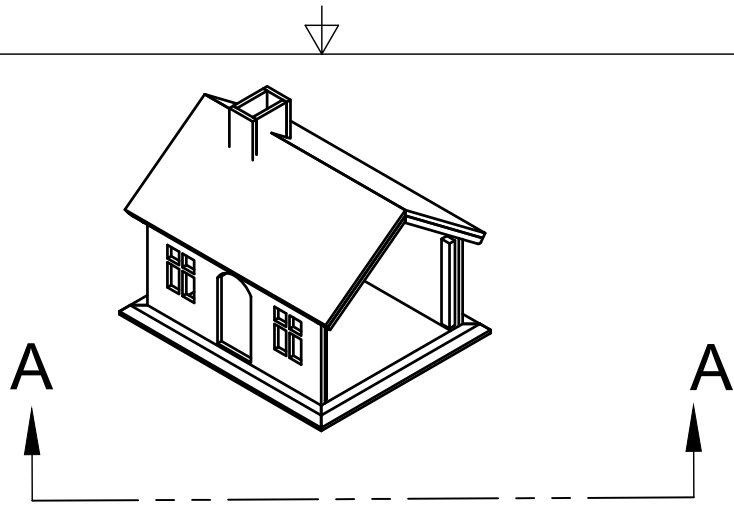

SECTION A-A
SCALE 1:3



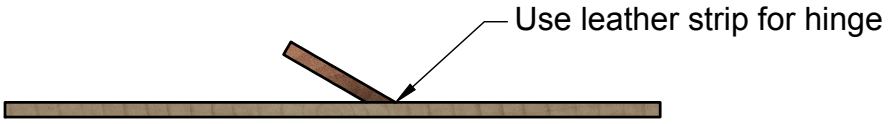
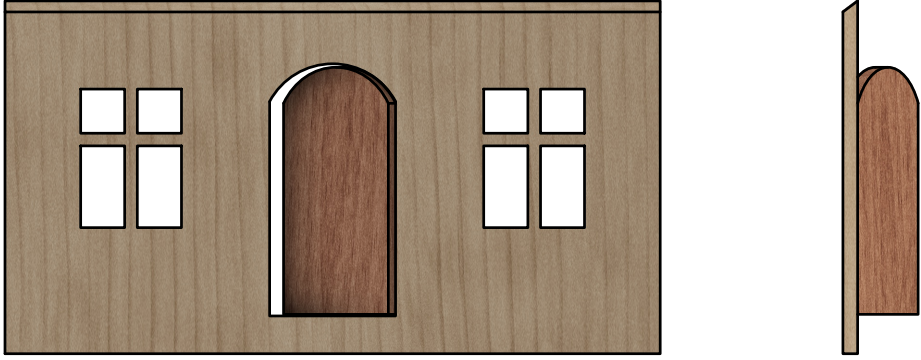
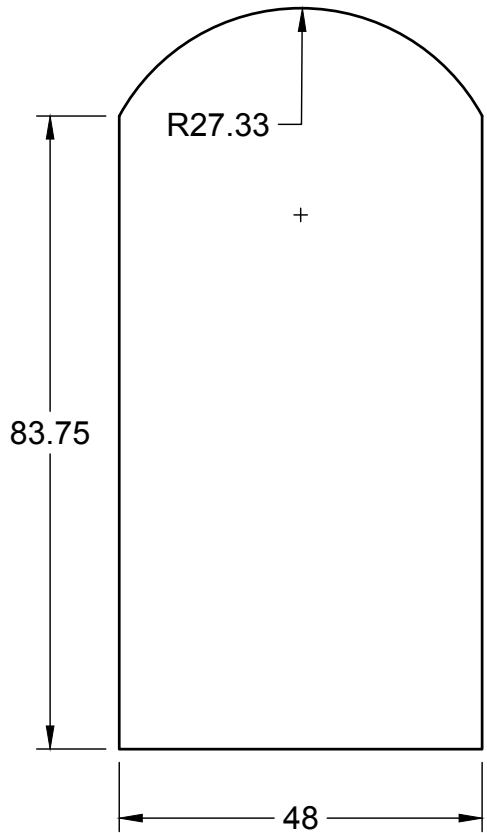

Door

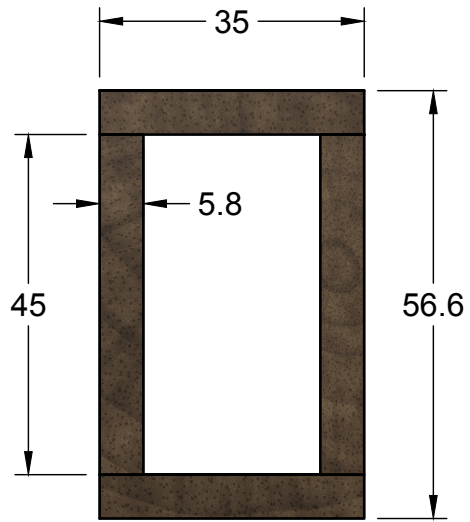
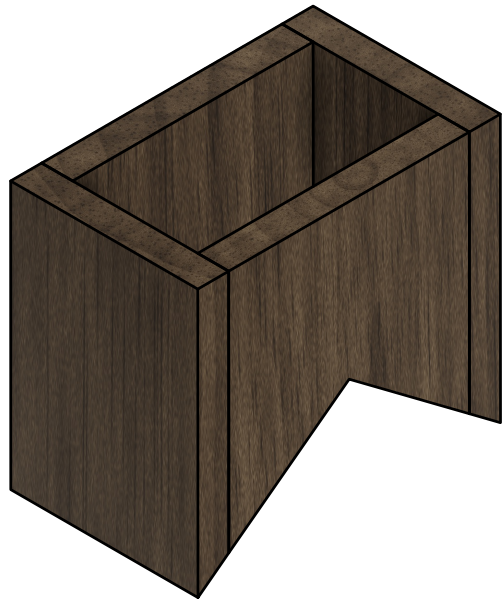

Top View

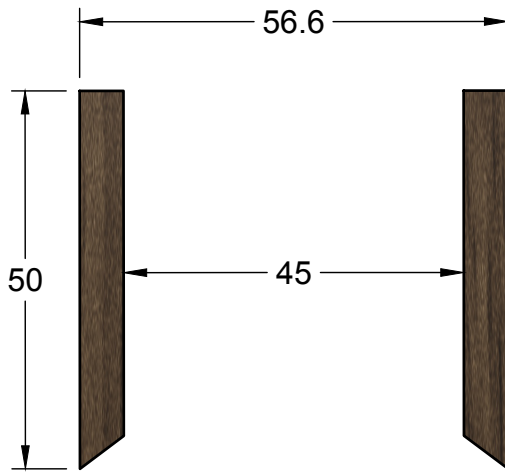
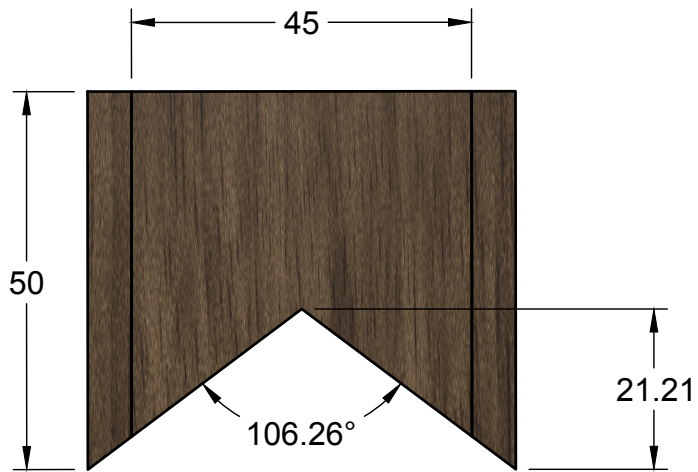

Chimney