

---

# **1608 SMD LED**

# **0603 SMD LED**

## **Applications**

- Signal & Symbol Indicators.
- Illuminations(illuminated advertising & general lighting).
- Amusement Machines.
- LCD Backlighting.
- Indoor & Outdoor Displays.
- Automobile Interior Lighting.

## 1. RED 1608 SMD LED

PART NO	Chip		Lens Color
	Material	Emitted Color	
LED-0603RVC	AlGaInP	Red ■	WATER CLEAR

### Absolute Maximum Ratings (Ta = 25°C)

Items	Symbol	Absolute maximum Rating	Unit
Power Dissipation	PD	60	mW
Forward Current(DC)	IF	20	mA
Peak Forward Current *	IFP	60	mA
Reverse Voltage	VR	5	V
Operation Temperature	Topr	-40 ~ +85	°C
Storage Temperature	Tstg	-40 ~ +90	°C
Soldering Temperature	Tsol	Reflow Soldering:240°C/10sec Hand Soldering: 350°C/3sec	

\*Pulse width  $\leq$  0.1msec duty  $\leq$  1/10

### Typical Electrical & Optical Characteristics ( Ta = 25°C )

Items	Symbol	Condition	Min.	Typ.	Max.	Unit
Forward Voltage	VF	IF = 20mA	1.7		2.4	V
Reverse Current	IR	VR = 5V			5	$\mu$ A
Dominant Wavelength	WLD	IF = 10mA	620		635	nm
Luminous Intensity	IV	IF = 10mA		80		mcd
50% Power Angle	2 $\theta$ $\frac{1}{2}$	IF = 10mA		120		Deg

### Typical Electrical/Optical Characteristics Curves (Ta=25° Unless Otherwise Noted)

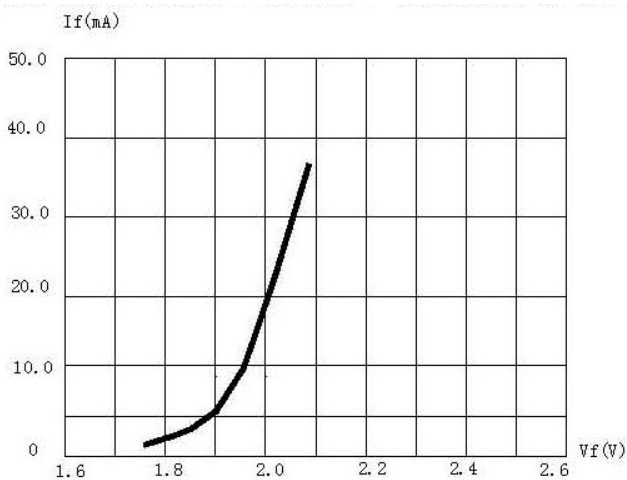

Forward Current vs. Forward Voltage

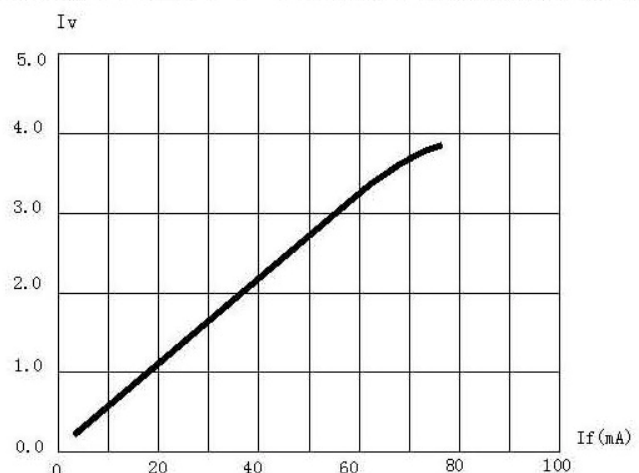

Relative Luminous Intensity vs. Forward Current

Half Width =  $\Delta 17\text{nm}$   
 Domi WL = 623nm

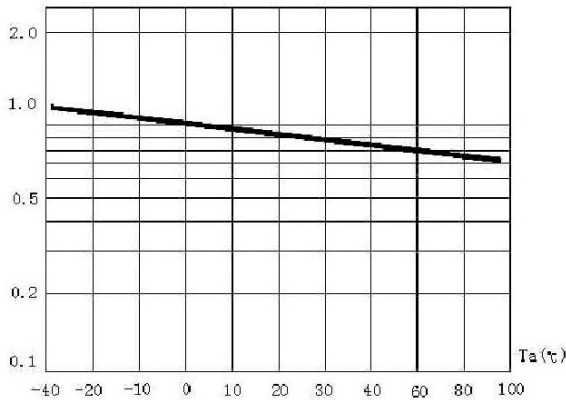

Relative Luminous Intensity vs. Ambient Temperature

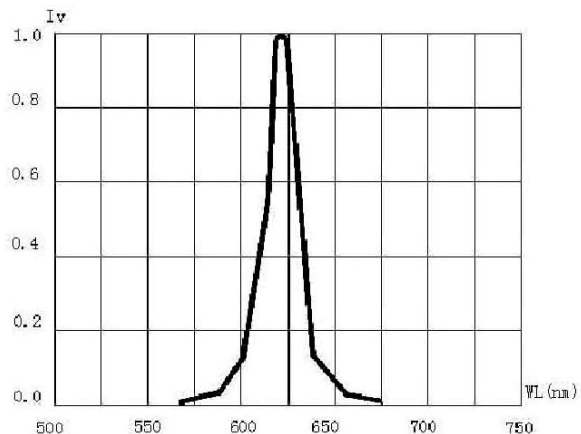

Relative Luminous Intensity vs. Wavelength

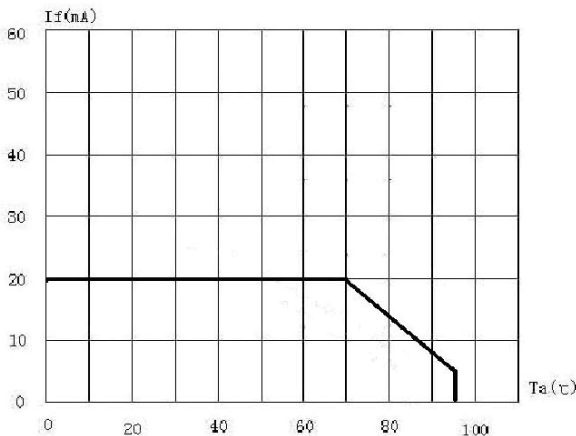

Maximum Forward Current vs. Ambient Temperature

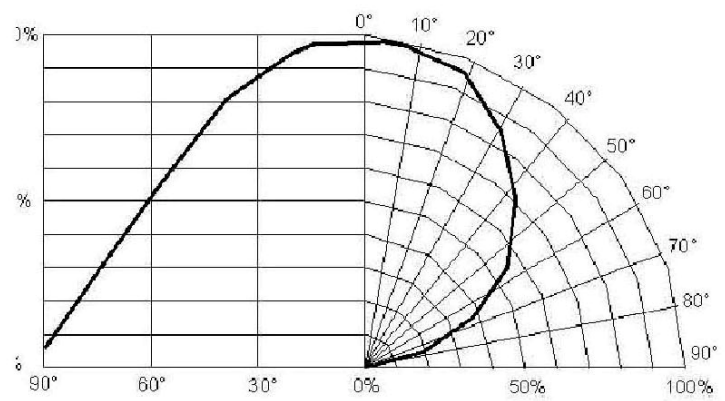

Relative Luminous Intensity vs. Radiation Angle

## 2. YELLOW 1608 SMD LED

PART NO	Chip		Lens Color
	Material	Emitted Color	
LED-0603YVC	AlGaInP	Yellow <span style="color: yellow;">■</span>	WATER CLEAR

### Absolute Maximum Ratings (Ta = 25°C)

Items	Symbol	Absolute maximum Rating	Unit
Power Dissipation	PD	60	mW
Forward Current(DC)	IF	20	mA
Peak Forward Current *	IFP	60	mA
Reverse Voltage	VR	5	V
Operation Temperature	Topr	-40 ~ +85	°C
Storage Temperature	Tstg	-40 ~ +90	°C
Soldering Temperature	Tsol	Reflow Soldering: 240°C/10sec Hand Soldering: 350°C/3sec	

\*Pulse width  $\leq 0.1\text{msec}$  duty  $\leq 1/10$

## Typical Electrical & Optical Characteristics ( Ta = 25°C )

Items	Symbol	Condition	Min.	Typ.	Max.	Unit
Forward Voltage	VF	IF = 20mA	1.7		2.4	V
Reverse Current	IR	VR = 5V			5	μA
Dominant Wavelength	WLD	IF = 10mA	580		595	nm
Luminous Intensity	IV	IF = 10mA		55		mcd
50% Power Angle	2θ½	IF = 10mA		120		Deg

## Typical Electrical/Optical Characteristics Curves (Ta=25° Unless Otherwise Noted)

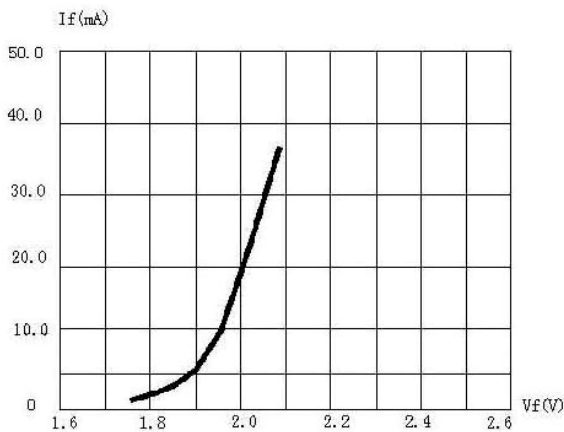

Forward Current vs. Forward Voltage

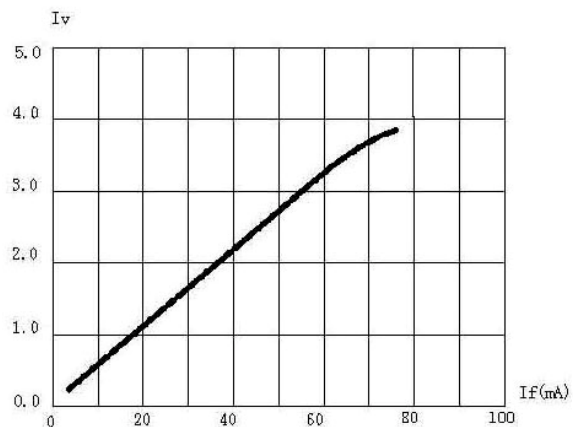

Relative Luminous Intensity vs. Forward Current

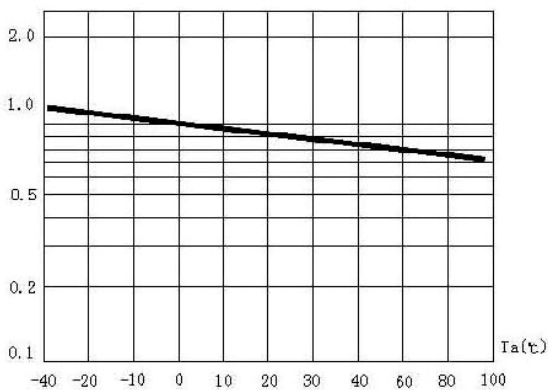

Relative Luminous Intensity vs. Ambient Temperature

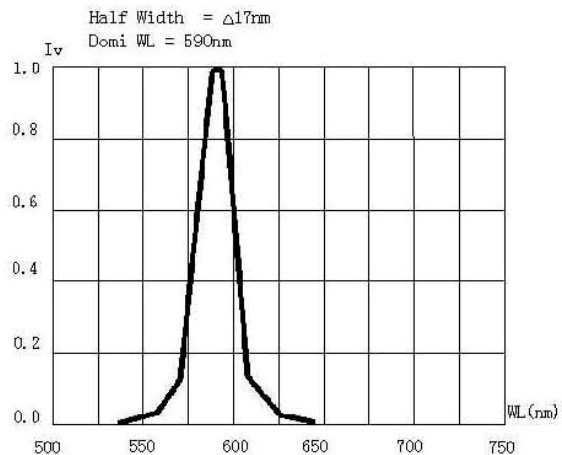

Relative Luminous Intensity vs. Wavelength

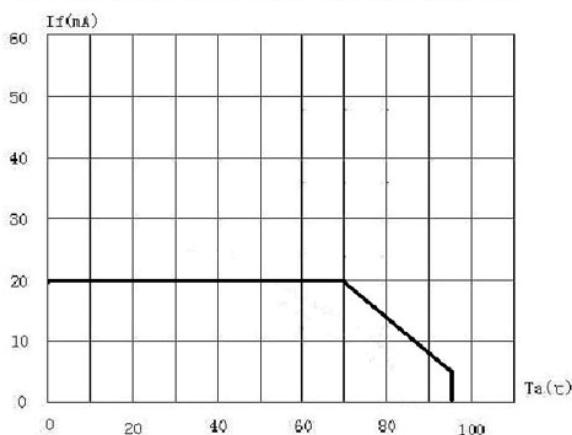

Maximum Forward Current vs. Ambient Temperature

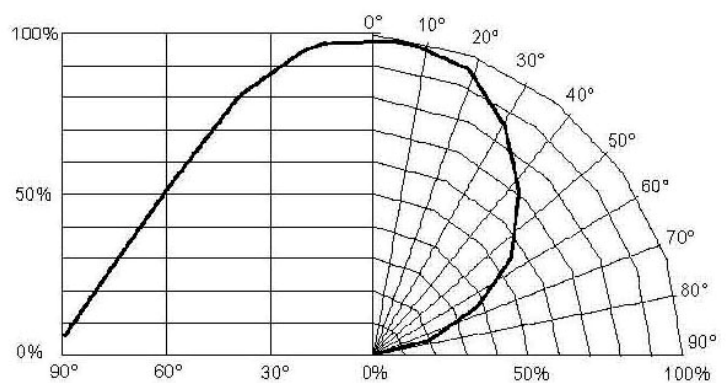

Relative Luminous Intensity vs. Radiation Angle

## 3. GREEN 1608 SMD LED

PART NO	Chip		Lens Color
	Material	Emitted Color	
LED-0603GVC	InGaN	Green ■	WATER CLEAR

### Absolute Maximum Ratings (Ta = 25°C)

Items	Symbol	Absolute maximum Rating	Unit
Power Dissipation	PD	60	mW
Forward Current(DC)	IF	20	mA
Peak Forward Current *	IFP	60	mA
Reverse Voltage	VR	5	V
Operation Temperature	Topr	-40 ~ +85	°C
Storage Temperature	Tstg	-40 ~ +90	°C
Soldering Temperature	Tsol	Reflow Soldering:240°C/10sec Hand Soldering: 350°C/3sec	

\*Pulse width  $\leq 0.1$ msec duty  $\leq 1/10$

### Typical Electrical & Optical Characteristics ( Ta = 25°C)

Items	Symbol	Condition	Min.	Typ.	Max.	Unit
Forward Voltage	VF	IF = 20mA	2.8		3.6	V
Reverse Current	IR	VR = 5V			5	$\mu$ A
Dominant Wavelength	WLD	IF = 10mA	515		530	nm
Luminous Intensity	IV	IF = 10mA		120		mcd
50% Power Angle	2 $\theta$ $\frac{1}{2}$	IF = 10mA		120		Deg

### Typical Electrical/Optical Characteristics Curves (Ta=25° Unless Otherwise Noted)

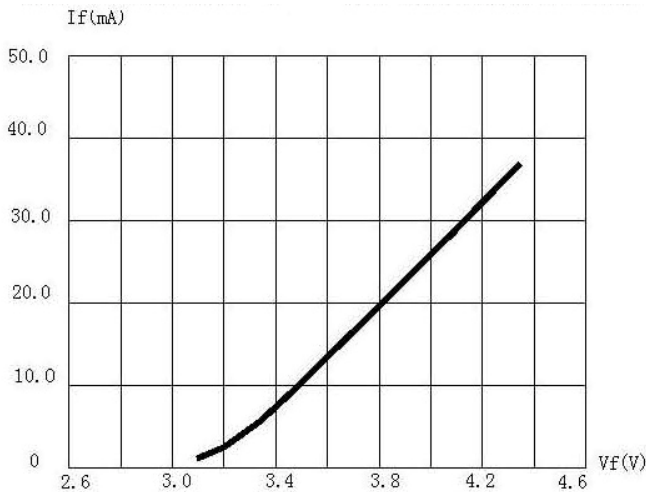

Forward Current vs. Forward Voltage

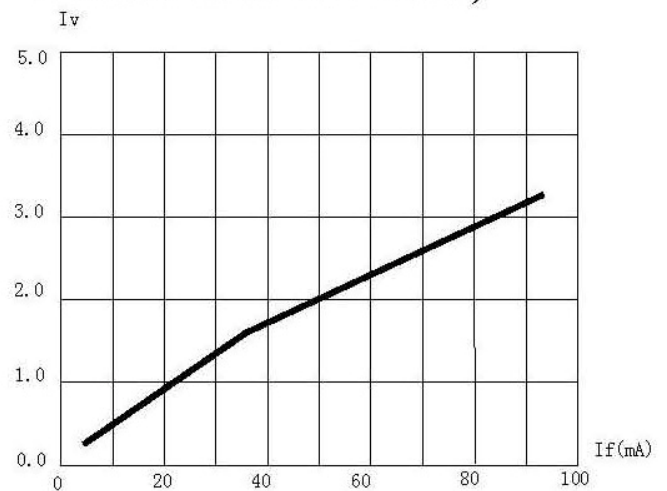

Relative Luminous Intensity vs. Forward Current

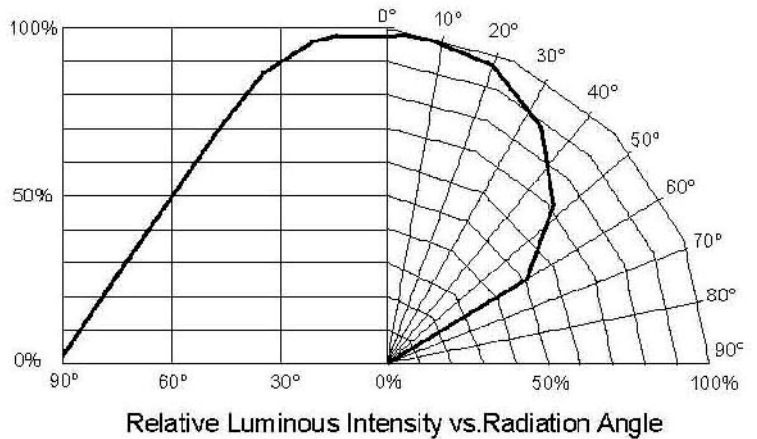
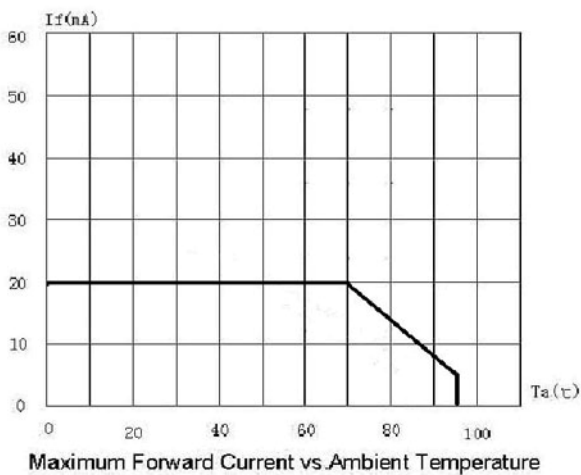
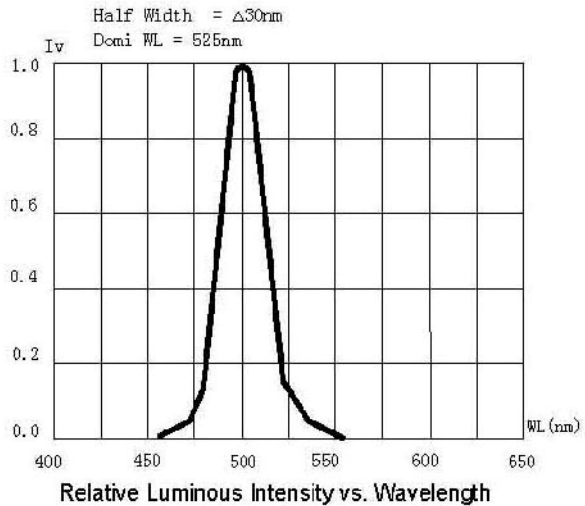
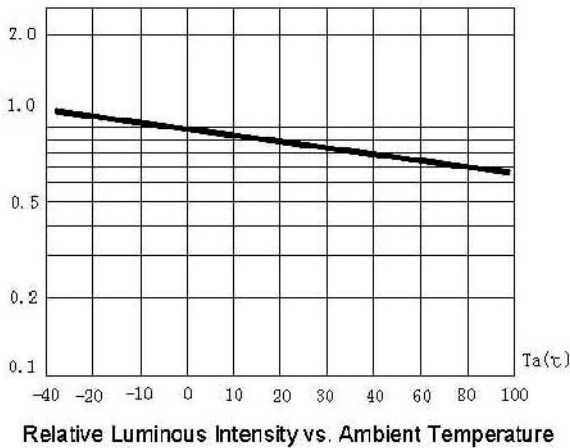

## 4. BLUE 1608 SMD LED

PART NO	Chip		Lens Color
	Material	Emitted Color	
LED-0603BVC	InGaN	Blue ■	WATER CLEAR

### Absolute Maximum Ratings (Ta = 25 °C)

Items	Symbol	Absolute maximum Rating	Unit
Power Dissipation	PD	60	mW
Forward Current(DC)	IF	20	mA
Peak Forward Current *	IFP	60	mA
Reverse Voltage	VR	5	V
Operation Temperature	Topr	-40 ~ +85	°C
Storage Temperature	Tstg	-40 ~ +90	°C
Soldering Temperature	Tsol	Reflow Soldering:240°C/10sec Hand Soldering: 350°C/3sec	

\*Pulse width  $\leq 0.1\text{msec}$  duty  $\leq 1/10$

## Typical Electrical & Optical Characteristics ( Ta = 25°C )

Items	Symbol	Condition	Min.	Typ.	Max.	Unit
Forward Voltage	VF	IF = 20mA	2.8		3.6	V
Reverse Current	IR	VR = 5V			5	μA
Dominant Wavelength	WLD	IF = 10mA	460		475	nm
Luminous Intensity	IV	IF = 10mA		70		mcd
50% Power Angle	2θ½	IF = 10mA		120		Deg

## Typical Electrical/Optical Characteristics Curves (Ta=25° Unless Otherwise Noted)

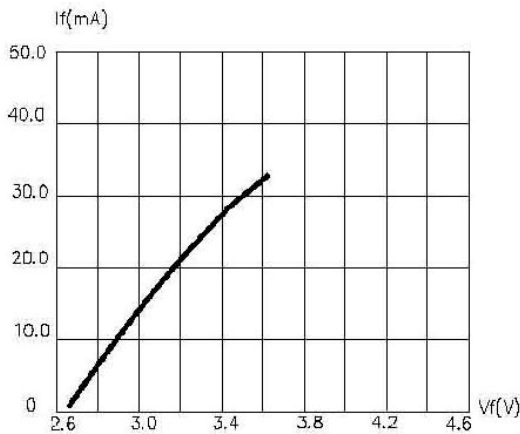

Forward Current vs. Forward Voltage

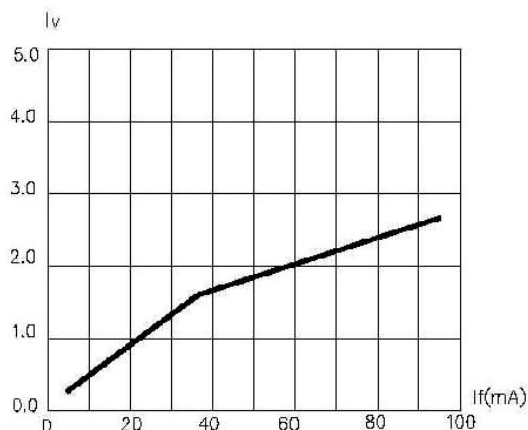

Relative Luminous Intensity vs. Forward Current

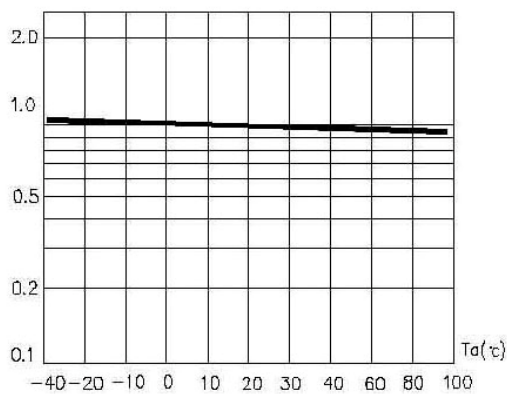

Relative Luminous Intensity vs. Ambient Temperature

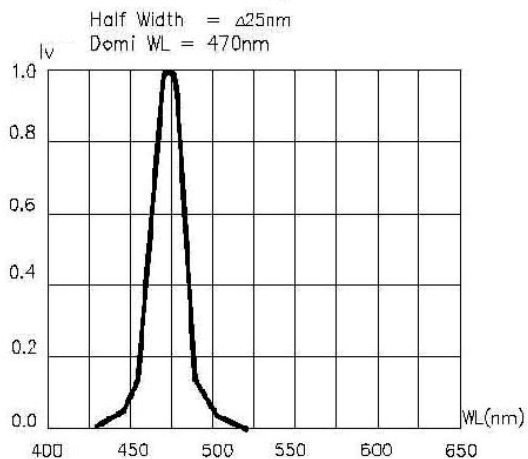

Relative Luminous Intensity vs. Wavelength

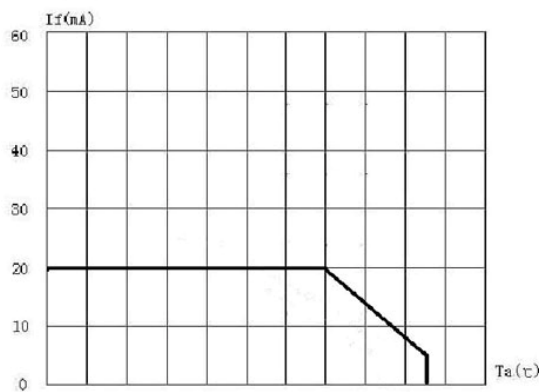

Maximum Forward Current vs. Ambient Temperature

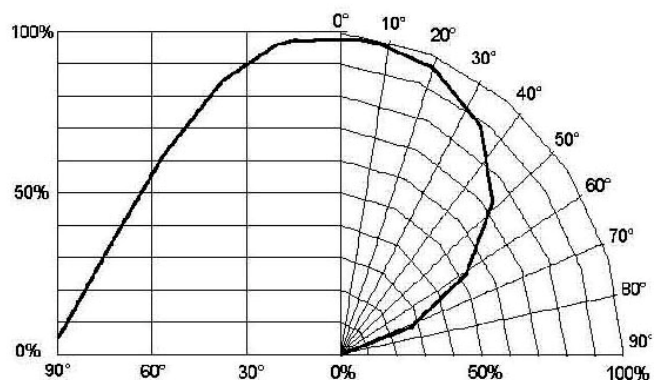

Relative Luminous Intensity vs. Radiation Angle

## 5. WHITE 1608 SMD LED

PART NO	Chip		Lens Color
	Material	Emitted Color	
LED-0603WVC	InGaN	White □	WATER CLEAR

### Absolute Maximum Ratings (Ta = 25°C)

Items	Symbol	Absolute maximum Rating	Unit
Power Dissipation	PD	60	mW
Forward Current(DC)	IF	20	mA
Peak Forward Current *	IFP	60	mA
Reverse Voltage	VR	5	V
Operation Temperature	Topr	-40 ~ +85	°C
Storage Temperature	Tstg	-40 ~ +90	°C
Soldering Temperature	Tsol	Reflow Soldering:240°C/10sec Hand Soldering: 350°C/3sec	

\*Pulse width  $\leq$  0.1msec duty  $\leq$  1/10

### Typical Electrical & Optical Characteristics ( Ta = 25°C)

Items	Symbol	Condition	Min.	Typ.	Max.	Unit
Forward Voltage	VF	IF = 20mA	2.8		3.6	V
Reverse Current	IR	VR = 5V			10	$\mu$ A
Chromatic Coordinates	(X,Y)	IF = 10mA			(0.30,0.30)	nm
Luminous Intensity	IV	IF = 10mA		180		mcd
50% Power Angle	2 $\theta$ ½	IF = 10mA		120		Deg



**CIE Chromaticity Chart**

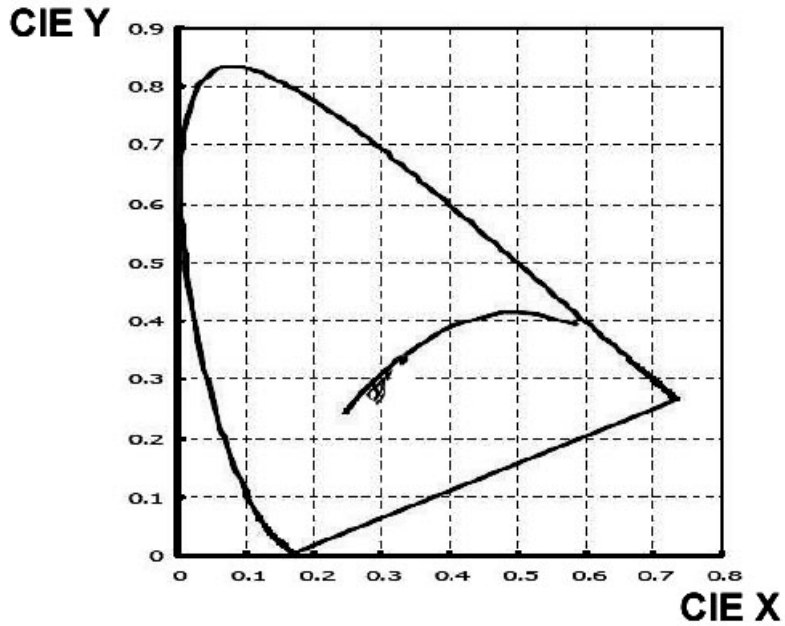

**Color Coordinate**

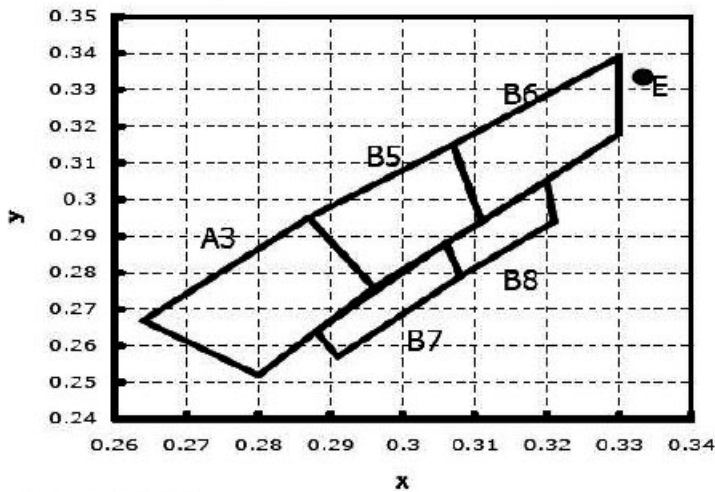

**Color Ranks**

Rank A3				Rank B5				Rank B7						
x	0.280	0.264	0.287	0.296	x	0.296	0.287	0.307	0.311	x	0.291	0.288	0.306	0.308
y	0.252	0.267	0.295	0.276	y	0.276	0.295	0.315	0.294	y	0.257	0.264	0.288	0.279

Rank B6				Rank B8					
x	0.311	0.307	0.330	0.330	x	0.308	0.288	0.32	0.321
y	0.294	0.315	0.339	0.318	y	0.279	0.264	0.305	0.294

\* Color coordinates measurement allowance is  $\pm 0.01$

**Typical Electrical/Optical Characteristics Curves (Ta=25° Unless Otherwise Noted)**

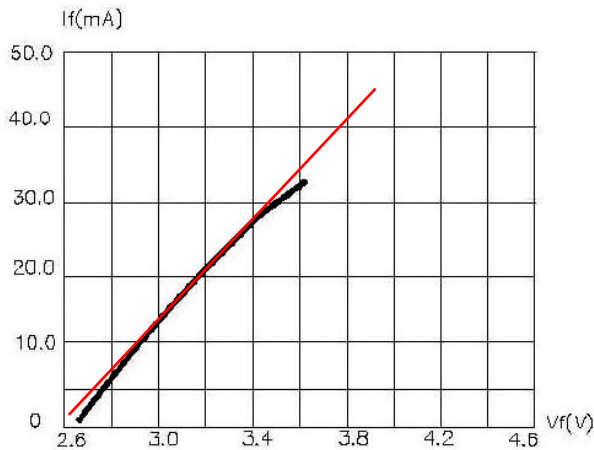

Forward Current vs. Forward Voltage

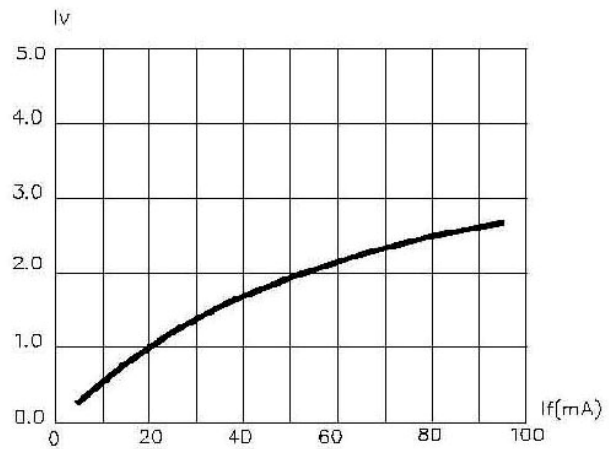

Relative Luminous Intensity vs. Forward Current

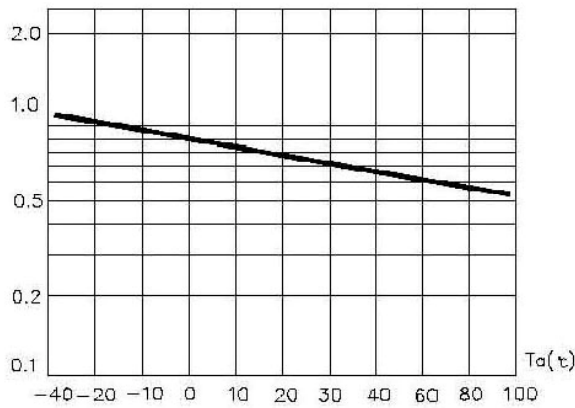

Relative Luminous Intensity vs. Ambient Temperature

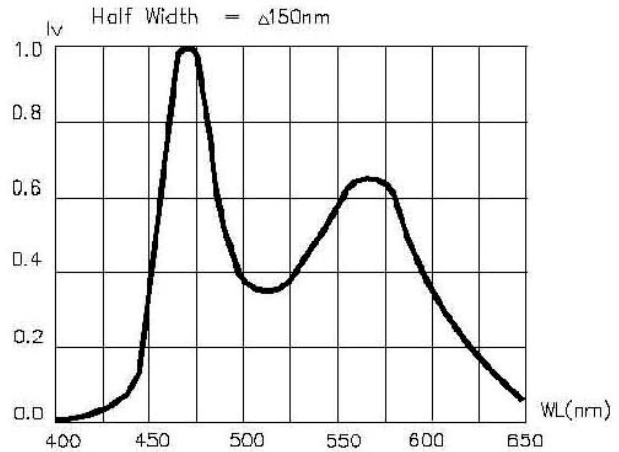

Relative Luminous Intensity vs. Wavelength

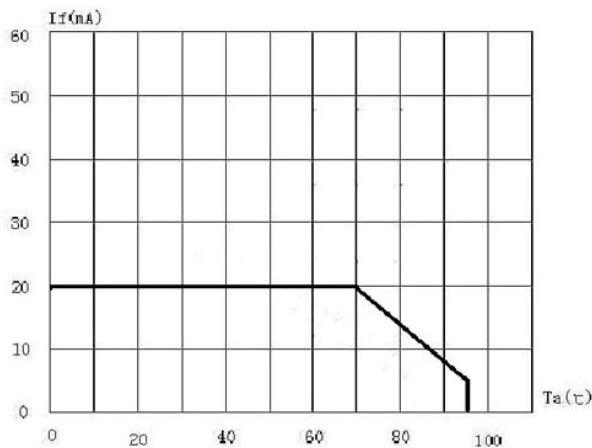

Maximum Forward Current vs. Ambient Temperature

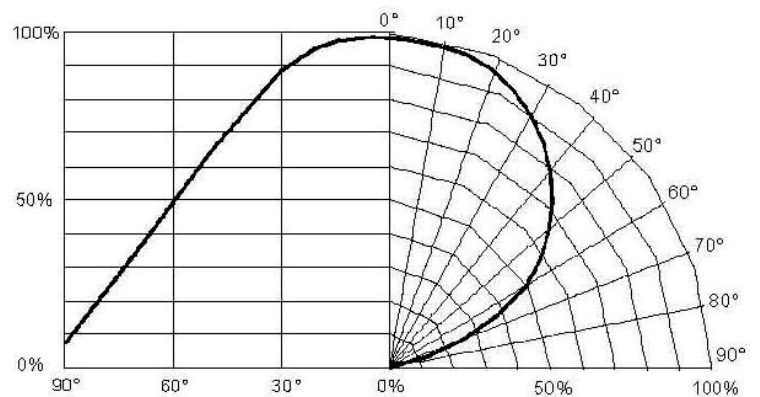

Relative Luminous Intensity vs. Radiation Angle

**Package Dimensions (unit:mm)**

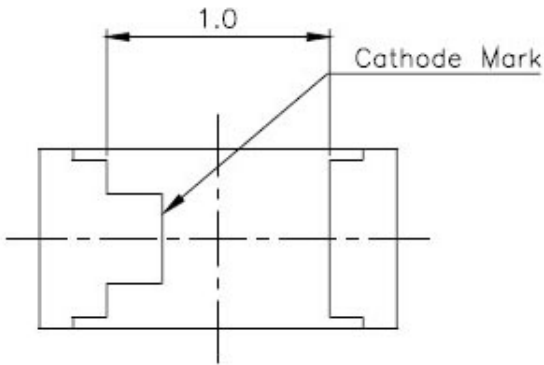
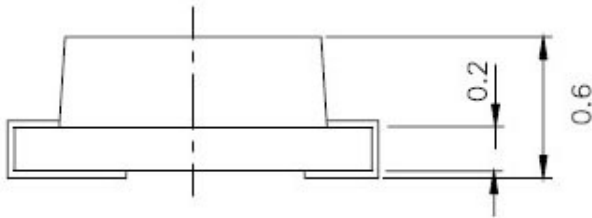
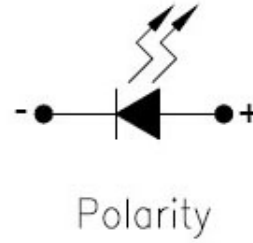
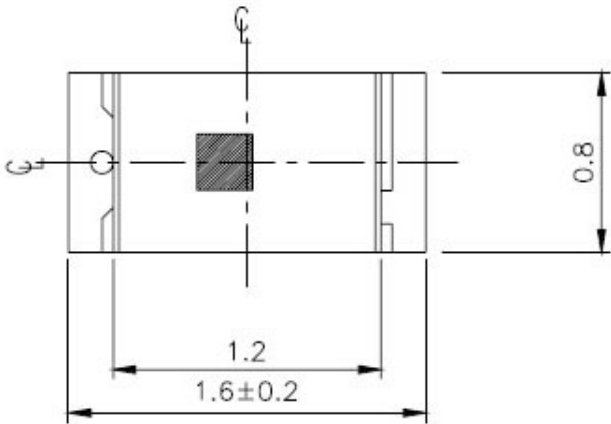

For reflow soldering (Propose)

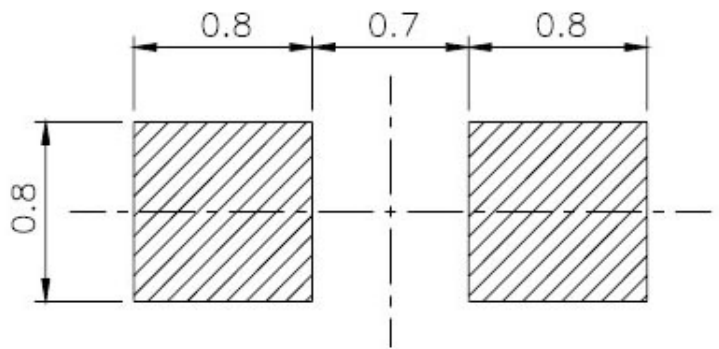

**Notes:**

All dimensions in mm tolerance is ±0.1mm unless otherwise noted.

**Carrier Tape Dimensions(unit:mm)**

**Loaded quantity 4000 PCS per reel**

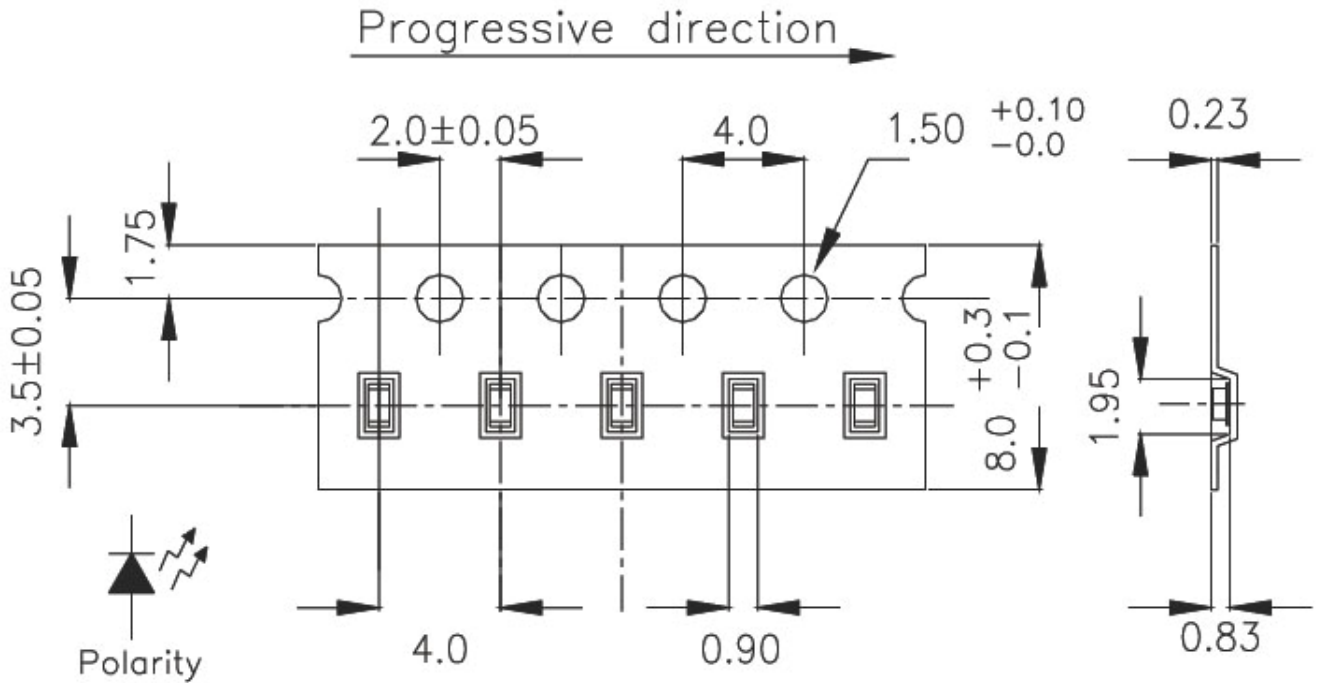

**Notes:**

All dimensions in mm tolerance is  $\pm 0.1$ mm unless otherwise noted.

**Copyright**

Copyright 2009, by ShenZhen Wayjun Technology Co.,Ltd. All rights are reserved. ShenZhen Wayjun Technology Co.,Ltd reserves the right to make improvements to the products described in this manual at any time without notice.

**Trademark**

The names used for identification only may be registered trademarks of their respective companies.