

Settings

Setting the Input Type to Normally-Closed or Normally-Open

1. Power down the PicoBoo.
2. Hold the "1" and "2" buttons to set the input to normally-closed, or just "1" to set it to normally-open.
3. Power up the PicoBoo while holding the button(s).
4. When the red light flashes a few times, you can let go of the buttons. The setting is now changed.

Write-Protecting Your Audio and Animation

Once the PicoBoo is programmed to your liking you can write-protect it to make sure the "REC" button is not accidentally pressed, changing or deleting your program. The write-protect setting can be toggled on or off using the following steps:

1. Power down the PicoBoo
2. Hold the "2" button and power up the PicoBoo.
3. When the red light flashes a few times the write-protect has been toggled.

Troubleshooting

| TROUBLESHOOTING TABLE | |
|---|---|
| Problem | Solution |
| "REC" light keeps flashing or the motion sensor won't trigger scare | - The motion sensor is warming up, wait 2 minutes, or - Input is set to normally-closed when it should be normally-open (see Trigger section for more details). |
| Can't record animation | - PicoBoo is write-protected, disable write-protection (see Settings section for more details), or - Audio source is still connected to Audio Line-In, disconnect. |
| Sound cuts out when output turns on or off | - Put diodes or capacitors on your solenoids (see Relay Outputs section for more details). |
| Sound cuts out when using the internal amplifier | - The power supply may be underpowered. Try reducing the volume or swapping out the power supply with one of higher wattage. |

Specifications

| SPECIFICATIONS TABLE | |
|----------------------|--|
| Audio | |
| Capacity | 120 seconds |
| Quality | 8kHz sample rate, mono (roughly equivalent to AM radio) |
| Storage Type | Internal Analog Flash |
| Physical | |
| Length | 5.375" |
| Width | 2.5" enclosure only, 3.5" including connectors |
| Height | 1.25" |
| Weight | 0.3 Lbs (0.14Kg) |
| Electrical | |
| Operating Voltage | 9 -12 VDC |
| Power Consumption | 2 watts (150mA) without amplifier, up to 30 watts (2.5 A) with |
| Relay Outputs | 120 VAC max., 10 amps max. (each output) |



PicoBoo

OPERATING MANUAL

V1.1 (Sep 8, 2011)



6 Oakside Court

Barrie, Ontario L4N 5V5

Tel: 1-877-815-5744 or 905-803-9274

www.frightideas.com

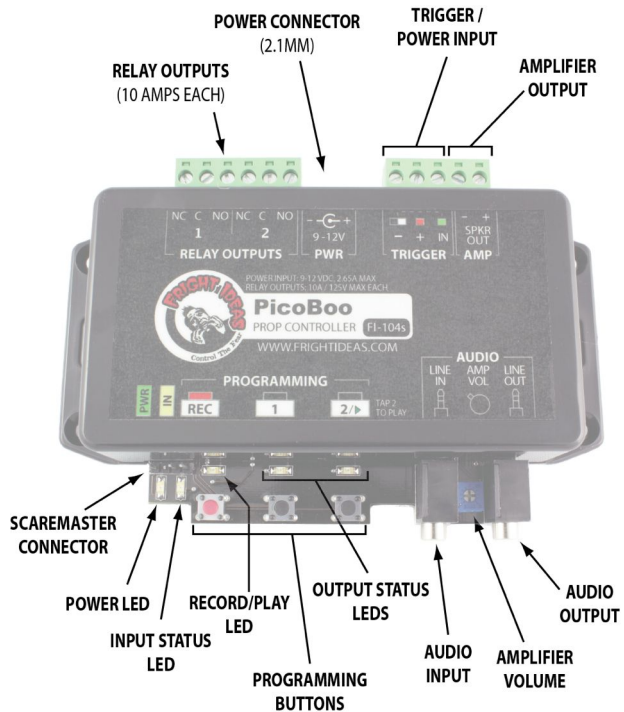

Wiring the Trigger

The PicoBoos are designed to work with low-voltage sensors or contact closures only. DO NOT use typical outdoor motion sensors found at local hardware stores. The PicoBoo will trigger when the IN terminal is connected to the GND terminal. As illustrated below, this can be accomplished in several ways.

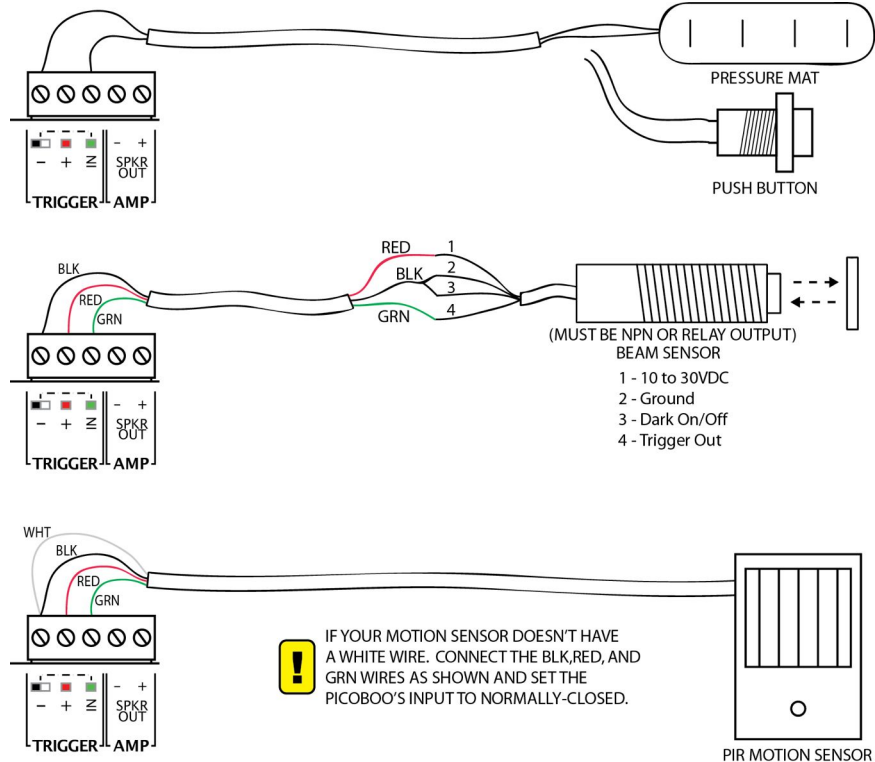

Using PIR Motion Sensors

Some motion sensor's outputs are normally-closed, meaning it connects the IN to GND when there's no motion, and disconnects it when there is. If this is the case, you must set the PicoBoo's input to normally-closed. See the Settings section on the next page for details on how to do this.

If you are unsure if your motion sensor is normally-open or normally-closed, connect it using the third diagram above. Power up the PicoBoo, wait a few minutes for the motion sensor to warm up. Trip your sensor as you watch the yellow input light on the PicoBoo. If the yellow light turns ON when the motion sensor activates, it's normally-open. If it turns off, it's normally-closed. If it does nothing there is a wiring problem.

Powering Up

Sizing your Power Supply

Your PicoBoo's power supply must always be 9 to 12 volts DC. The wattage you'll need depends on whether you're using the internal amp, and if you're trying to power solenoids from the same supply. Add up the wattage of all the devices that will be used at the same time and make sure your power supply's wattage is equal to or higher than that number. Use 2 watts for the PicoBoo if you're not using the amp, and 15 if you are. If your power supply does not have a wattage rating on it, multiply the A by the V to get it. If the A value has an "m" in front of it, divide it by 1000 first. For example, a 12V 500mA supply would be 12 x 0.5 = 6 Watts.

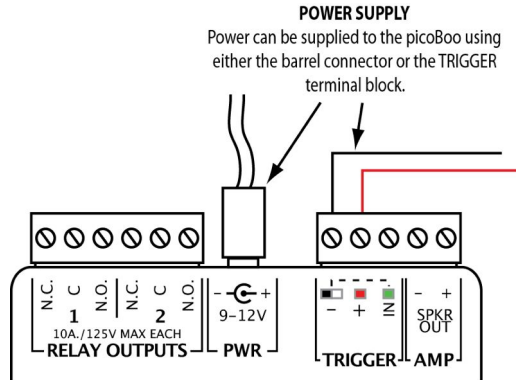

12 Volt DC Solenoids Powered from the PicoBoo's Power Supply

If the power supply used to power the PicoBoo is large enough, you can use it to power the solenoid as well. Use the trigger terminal block to "borrow" the PicoBoo's power supply. When sizing your power supply, make sure you reserve at least 2 watts for the PicoBoo, if you're not using the amp, and at least 15 watts if you are. A diode is recommended to help reduce feedback, read below for more details.

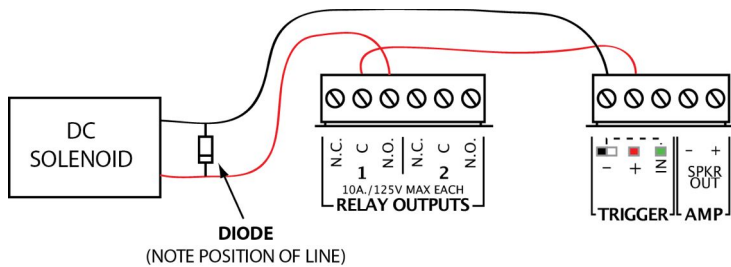

24 Volt DC Solenoids or Any DC Solenoid Powered from a Separate Power Supply

If your solenoid is not 12 VDC, or your PicoBoo's power supply does not have enough wattage to power both the PicoBoo and the valve, you'll need to use a separate power supply. Diodes are recommended to absorb feedback from DC solenoids. Note the orientation of the diode, using the line on the one side as a guide. Locate the diode as close to the solenoid as possible. A standard 1N4001 – 1N4004 diode will work fine, and they're available for less than a dollar at your local Radio Shack. (Radio Shack part numbers 276-1103 or 276-1102)

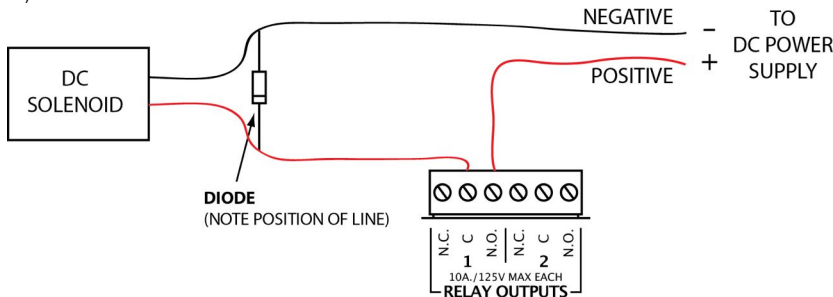

Recording the Output Animation

1. Make sure there is no audio cable connected to the PicoBoo's Audio Line-In.
2. Press "REC". The red light will turn on and the scare sound will start playing.
3. Press the "1" and "2" output buttons to turn on the outputs as you want them to turn on. Synchronize your actions with the sound. You can press each button as many times as you want or hold them for as long as you want. Whatever you do on those buttons will be recorded for up to 2 minutes.
4. Press "REC" again to stop recording. The scene is automatically saved. Press "2" or trigger the input to preview the scene.

NOTE: If you are having problems recording and are using a motion sensor for a trigger, disconnect the motion sensor and change the input back to normally-open before recording.

Getting Set Up for Recording Audio

To begin recording you will need the following connected to the PicoBoo:

- A powered speaker or speakers connected to the PicoBoo's Audio Line-Out.
- An audio source such as an iPod, Computer, or CD player connected to Audio Line-In.
- A stereo audio cable to connect your audio source to the PicoBoo's Audio Line-In.



Once the above is connected, press play on the audio source and you should be able to hear the sound faintly through the connected speaker. DO NOT turn up the source volume so your speakers are really loud! Use this sound only as a guide so you know when to start and stop recording. Once the sound is recorded and the PicoBoo plays it back, it will be much louder than it is now.

You will have to experiment with the volume of your sound source to see what gives you the best recorded sound quality. If the source is too loud, the recording will sound distorted. If it's too low you may not be able to turn the sound up loud enough even with your speakers at full volume. Do a few test recordings. Keep adjusting the source volume and then previewing the sound from the PicoBoo until you're happy with the quality and volume level.

| Volume Levels for Common Sources | |
|----------------------------------|--------------|
| Source | Volume Level |
| Computer | 20% to 70% |
| iPod or Portable CD Player | 75% |

Recording the Audio

The ambient sound must always be recorded first. Once you are happy with how it sounds you can move on to recording the scare sound. The scare sound can then be recorded and re-recorded as needed. If the ambient sound is ever changed the scare sound will have to be re-recorded, even if it does not need to be changed.

Sound Length

Record as long an ambient sound as possible, as this sound will be looped while the PicoBoo waits to be triggered. The looping point will be heard less often if the ambient sound is long. Make sure to leave enough room for your scare sound, as you have 2 minutes total space for your sounds.

Recording and Previewing

To record the ambient sound hold "REC" and press "1". Press "REC" again to stop recording. To record the scare sound hold "REC" and press "2". To preview the sound, make sure you stop the source if it is playing, then press either "1" to preview the ambient sound, or "2" to preview the scare sound. Pressing "1" or "2" again while the sound is playing will stop it.

Recording More Scare Sounds

Record your ambient and first scare sound as explained above. To record each additional scare sound, hold both "1" and "2", then press "REC". Repeat this for up to 10 scare sounds, the total length must still remain under 2 minutes. If you mess up you'll have to start over at the first scare sound by holding "2" and pressing "REC". To preview your additional scare sounds, first tap "2" to listen to the first scare sound, then tap "1" and "2" at the same time to listen to the additional sounds one at a time.

Turning Off Ambient Sound

To turn off the ambient sound, make sure that an audio source is connected to the Audio Line-In, hold "REC" and press "1". Then within 3 seconds, press "REC" again.

Using the Internal Amplifier

The PicoBoo has an internal 30 watt audio amplifier that can be used to drive standard speakers. Car speakers or horn speakers are typical. Horn speakers are inexpensive and work well for screams and other mid to high pitch sounds. Standard 4 or 8 ohm speakers are best if you are playing music or lower pitch sounds.

If you hear the audio cutting out as it plays, your power supply is likely overwhelmed. Either swap out the supply with one of higher wattage, or turn down the volume.

Below are three popular configurations for connecting speakers to the PicoBoo.

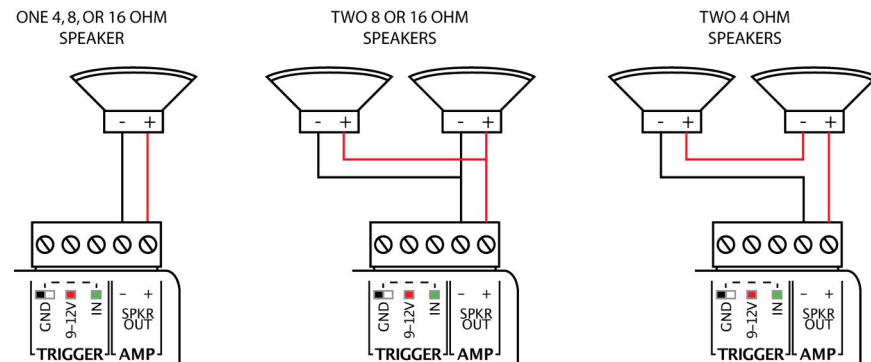

Wiring the Outputs

The outputs are simple contact closures, which are switches that you must wire to turn whatever device you want to control on or off. One wire must always go into the common terminal (C), the other into either the normally-open (N.O.) or normally-closed (N.C.). Using the N.O. terminal will result in the device normally being off, and turning on when you press the output's button, while the N.C. terminal will give you the opposite result. Each relay can handle 10 amps at 125 volts.

Controlling 120 Volt Loads

The easiest way to control a 120 volt load is to wire an extension cord through one of the output relays. Cut one of the wires, strip the two ends, and insert them into the C and N.O. terminals. If it's a three wire extension cord, cut the black wire as previously described.

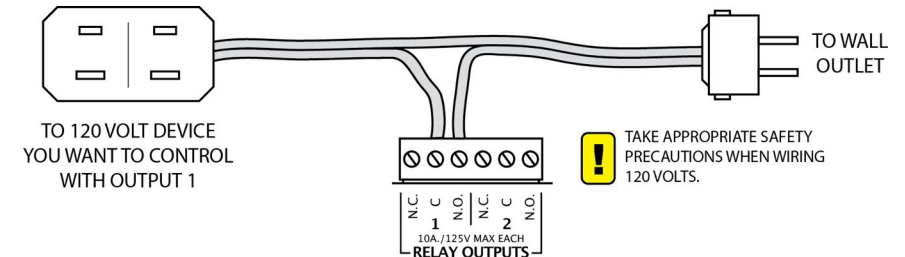

Controlling Solenoids or Large Relays

Solenoids and Large Relays create a lot of interference, which can wreak havoc with nearby electronic devices, including the PicoBoo. If you notice erratic behavior when controlling one of these devices, this is the most likely problem. The solution depends on whether you are using AC or DC solenoids.

120 VAC Solenoids

High voltage capacitors can be used to absorb feedback from AC solenoids. The best place to install them is as close to the solenoid as possible. If that's not possible, then across the terminal block may work as well. A 0.1uF capacitor rated for at least 200V is recommended. (Radio Shack part numbers 272-1053 or 272-1051)

