

4

3

2

1

D

D

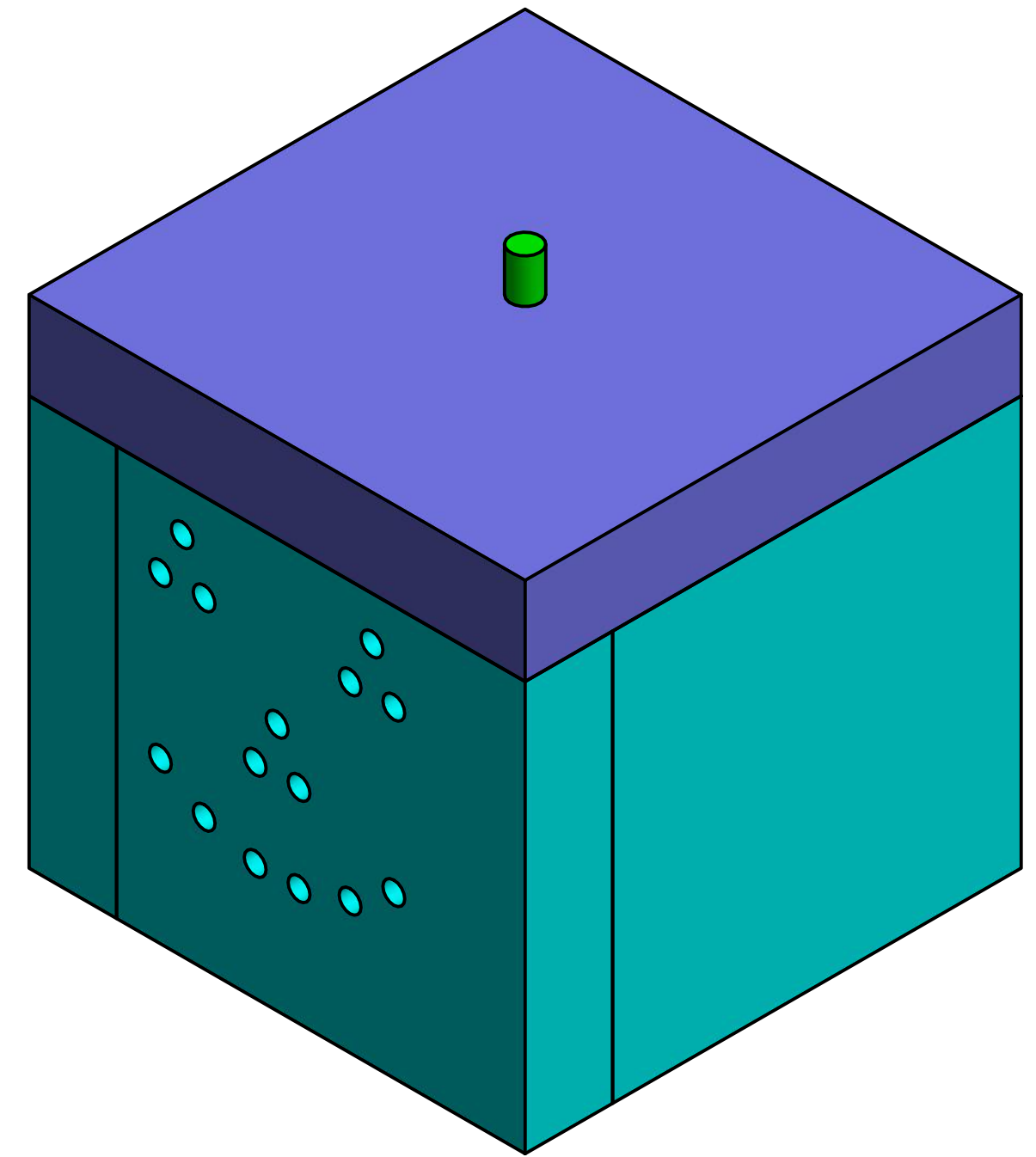
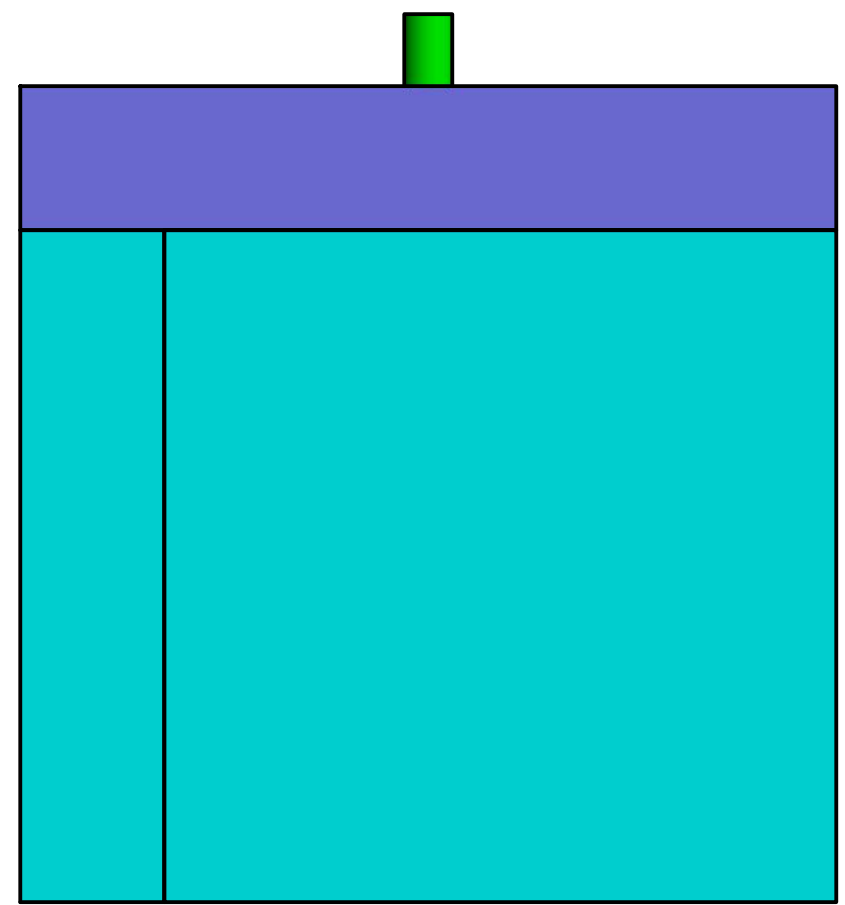
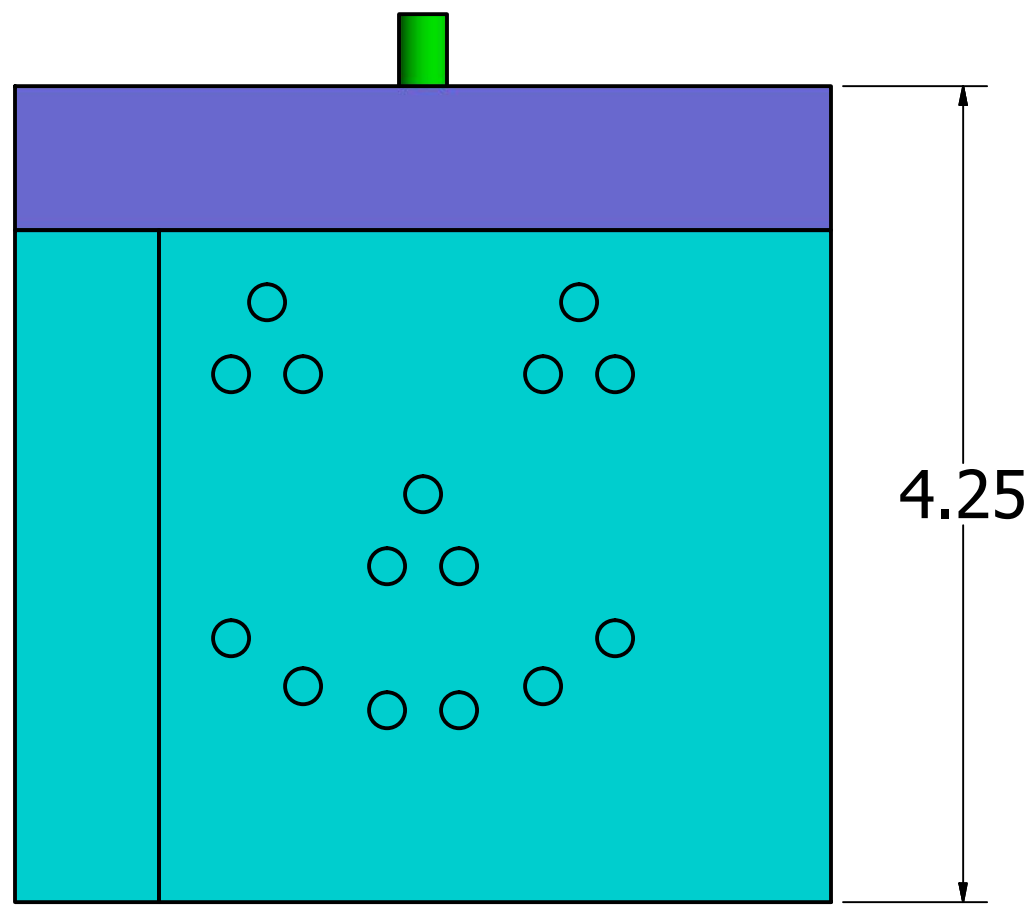

C

C

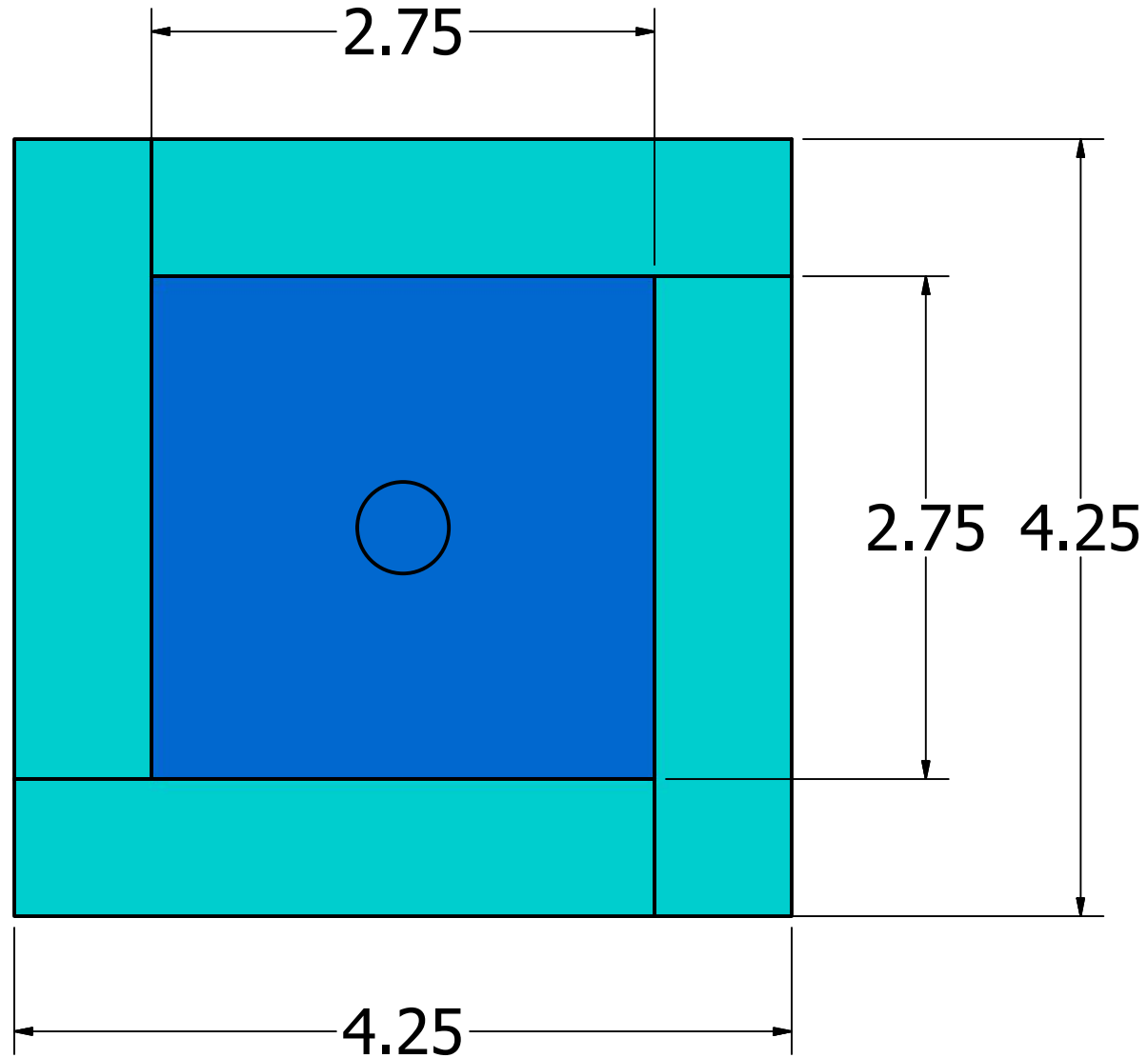

B

B

A

A

4

3

4

2

1

DRAWN	MI	9/5/2015		
CHECKED			TITLE	
QA				
MFG				
APPROVED				
		SIZE	DWG NO	REV
		C	pumpkin_boxes	
		SCALE	SHEET 1 OF 15	

4

3

2

1

D

D

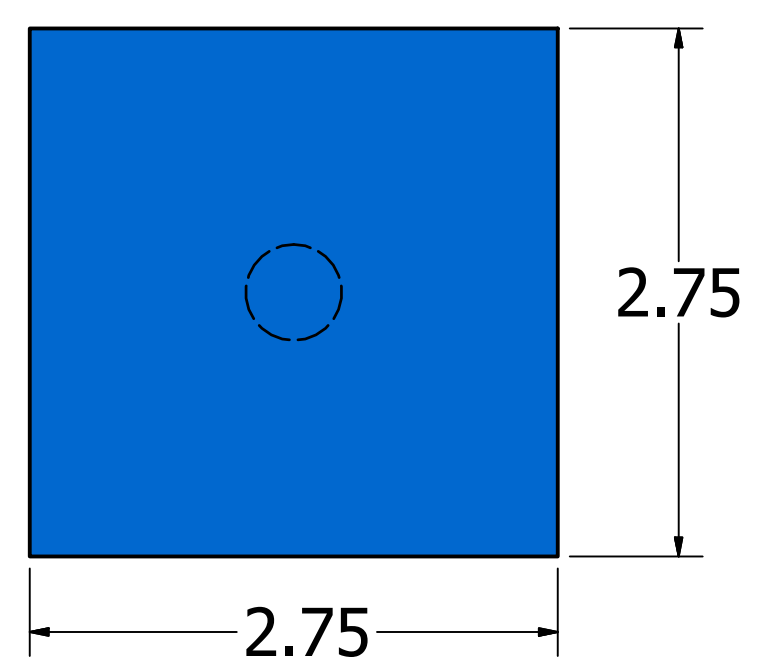
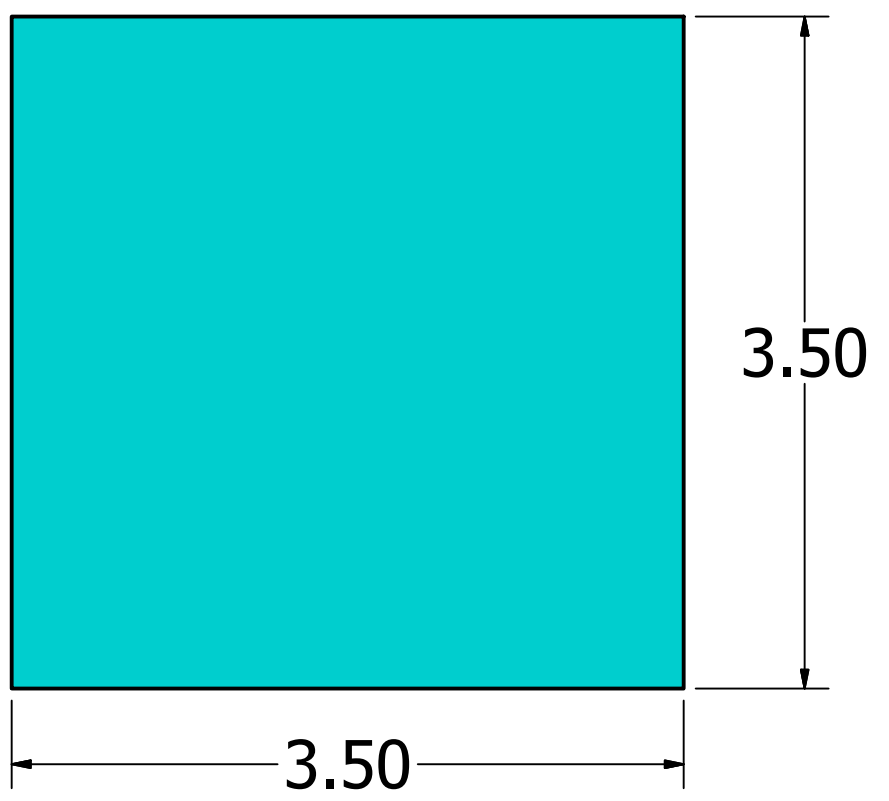
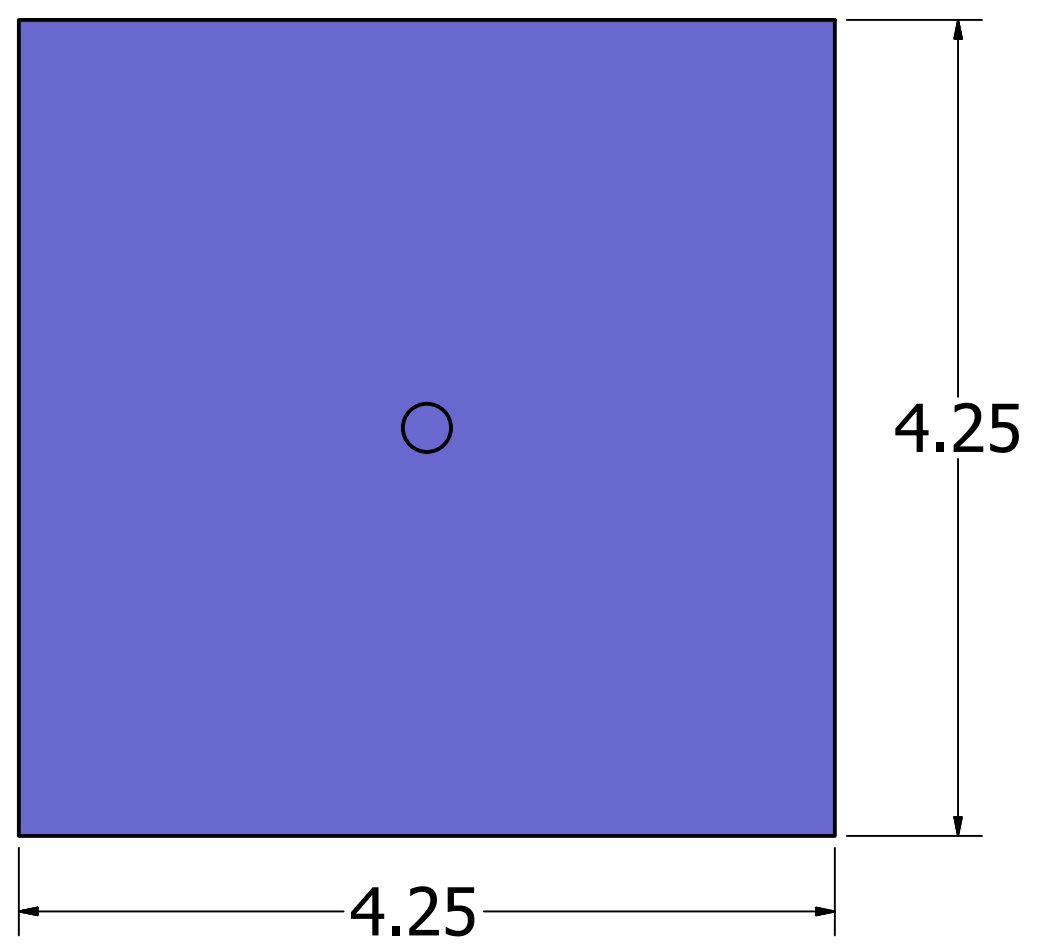
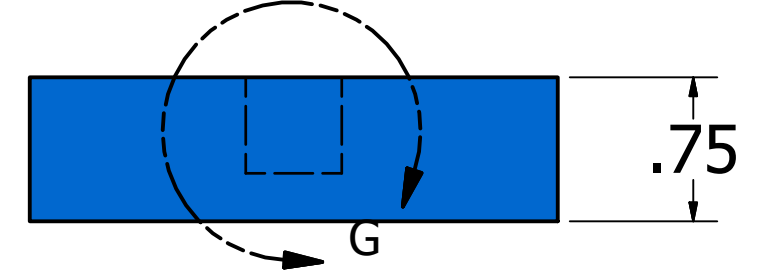
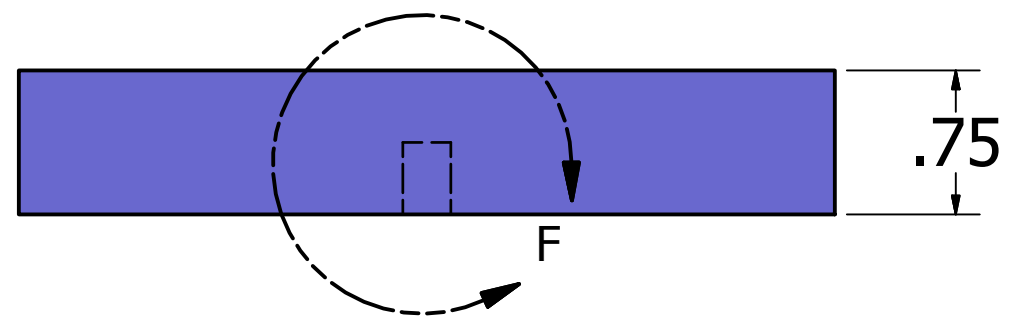

C

C

B

B

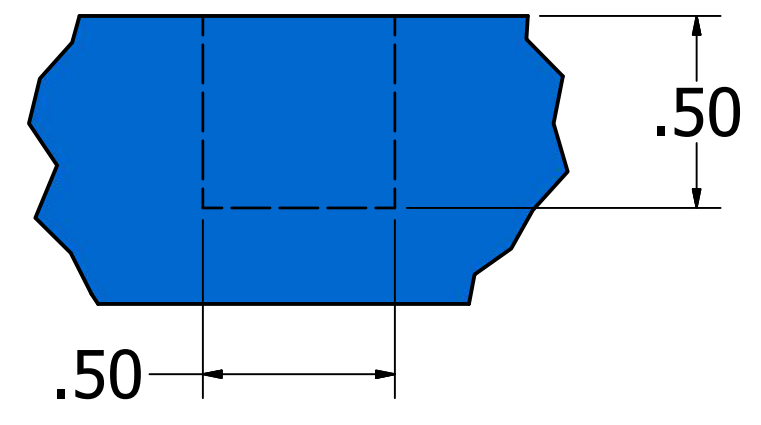
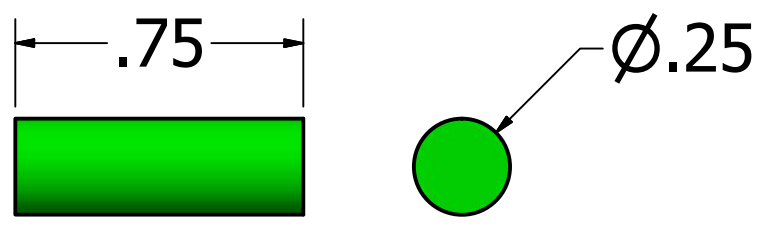
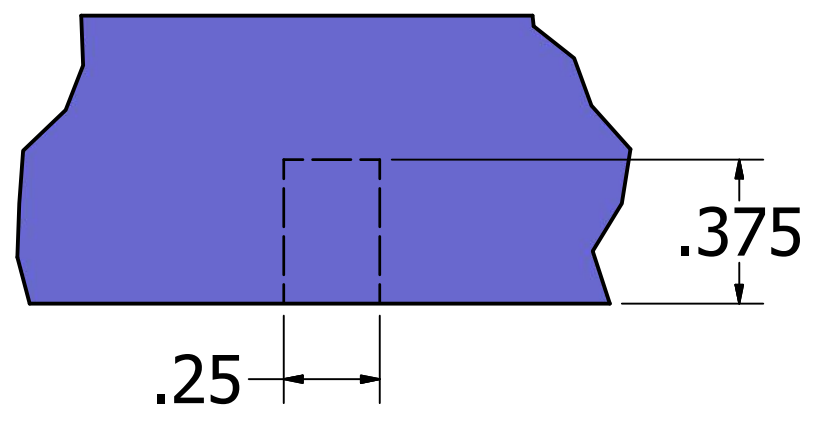

DETAIL F
SCALE 2 : 1

DETAIL G
SCALE 2 : 1

A

A

DRAWN	MI	9/5/2015		
CHECKED			TITLE	
QA				
MFG				
APPROVED				
		SIZE	DWG NO	REV
		C	pumpkin_boxes	
		SCALE	SHEET 2 OF 15	

4

3

4

2

1

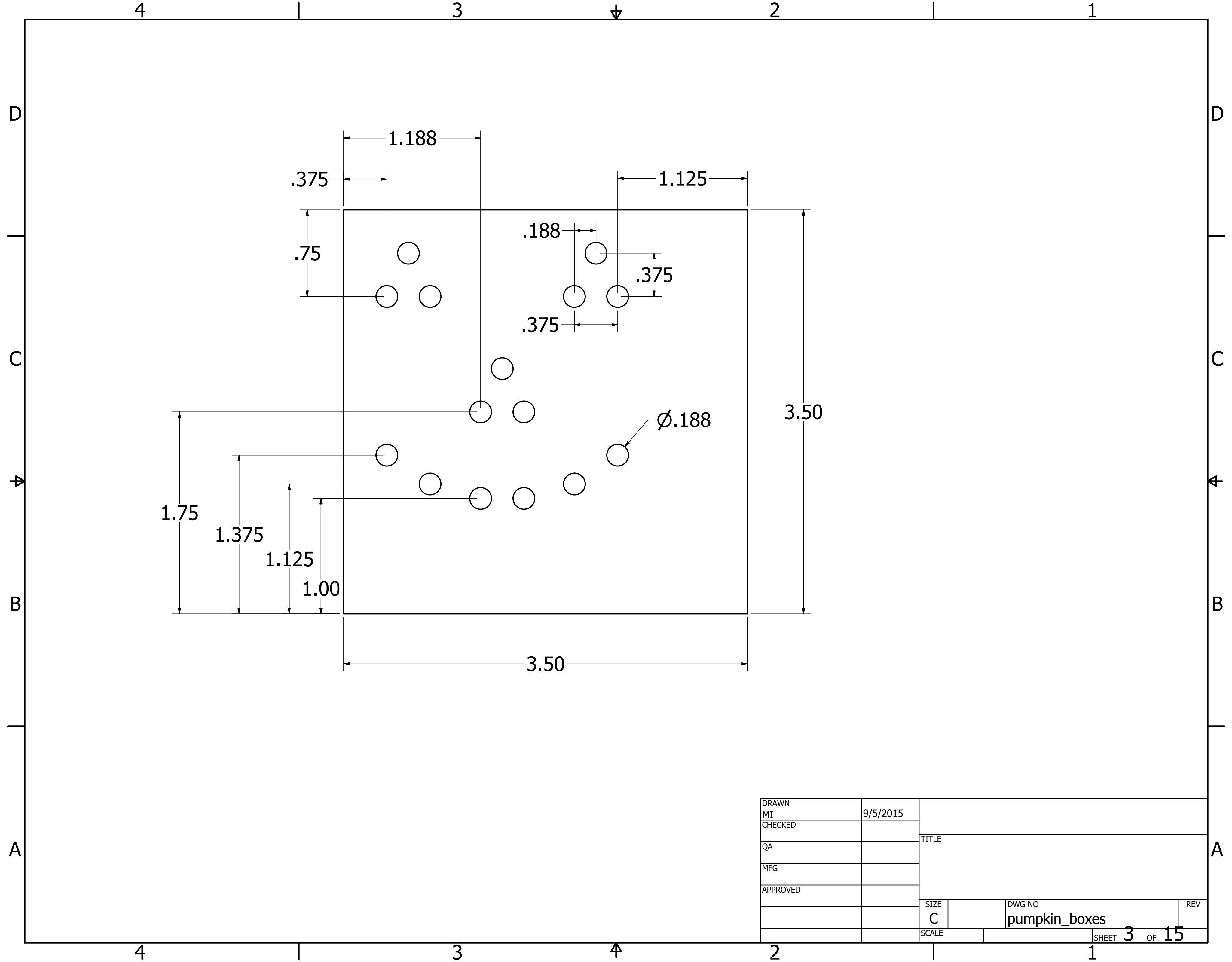

DRAWN	MI	9/5/2015		
CHECKED			TITLE	
QA				
MFG				
APPROVED				
		SIZE	DWG NO	REV
		C	pumpkin_boxes	
		SCALE	SHEET 3 OF 15	

4

3

2

1

D

D

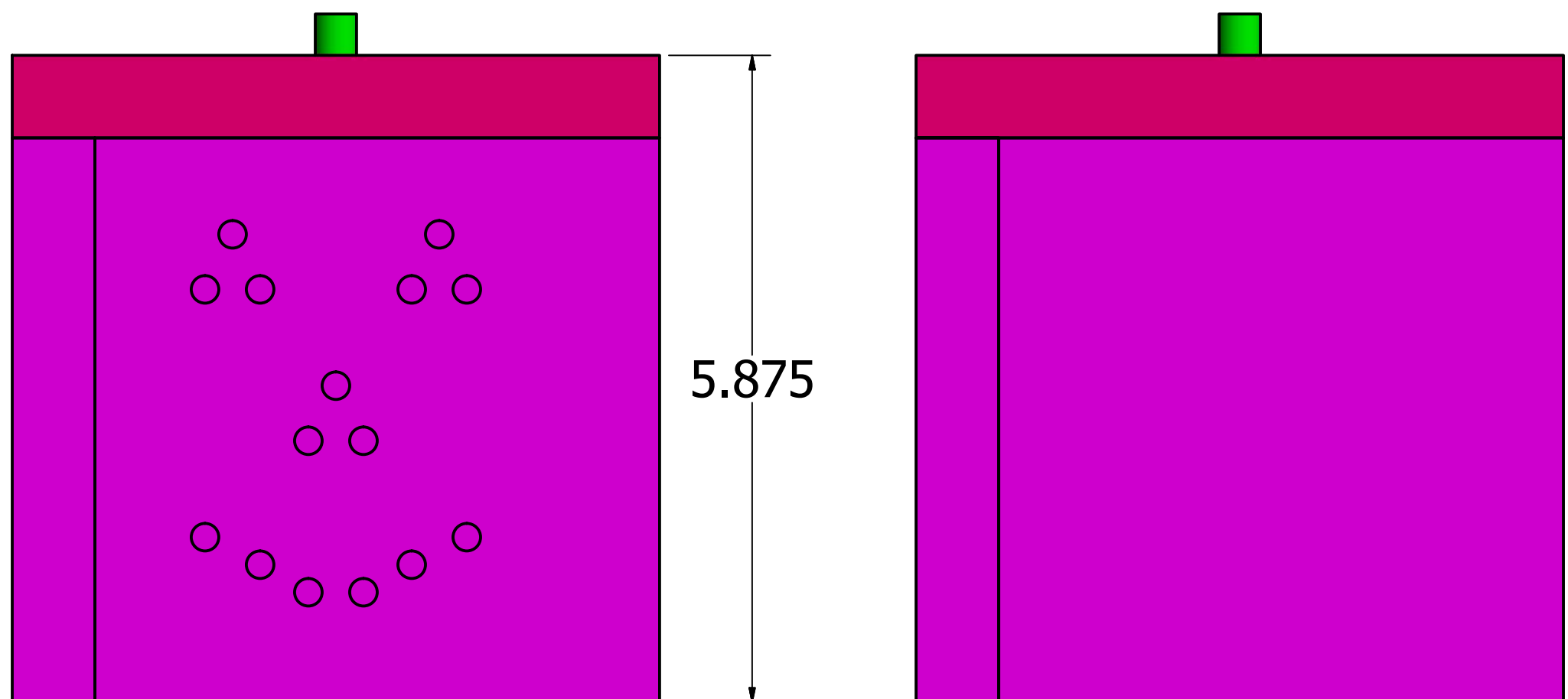

5.875

C

C

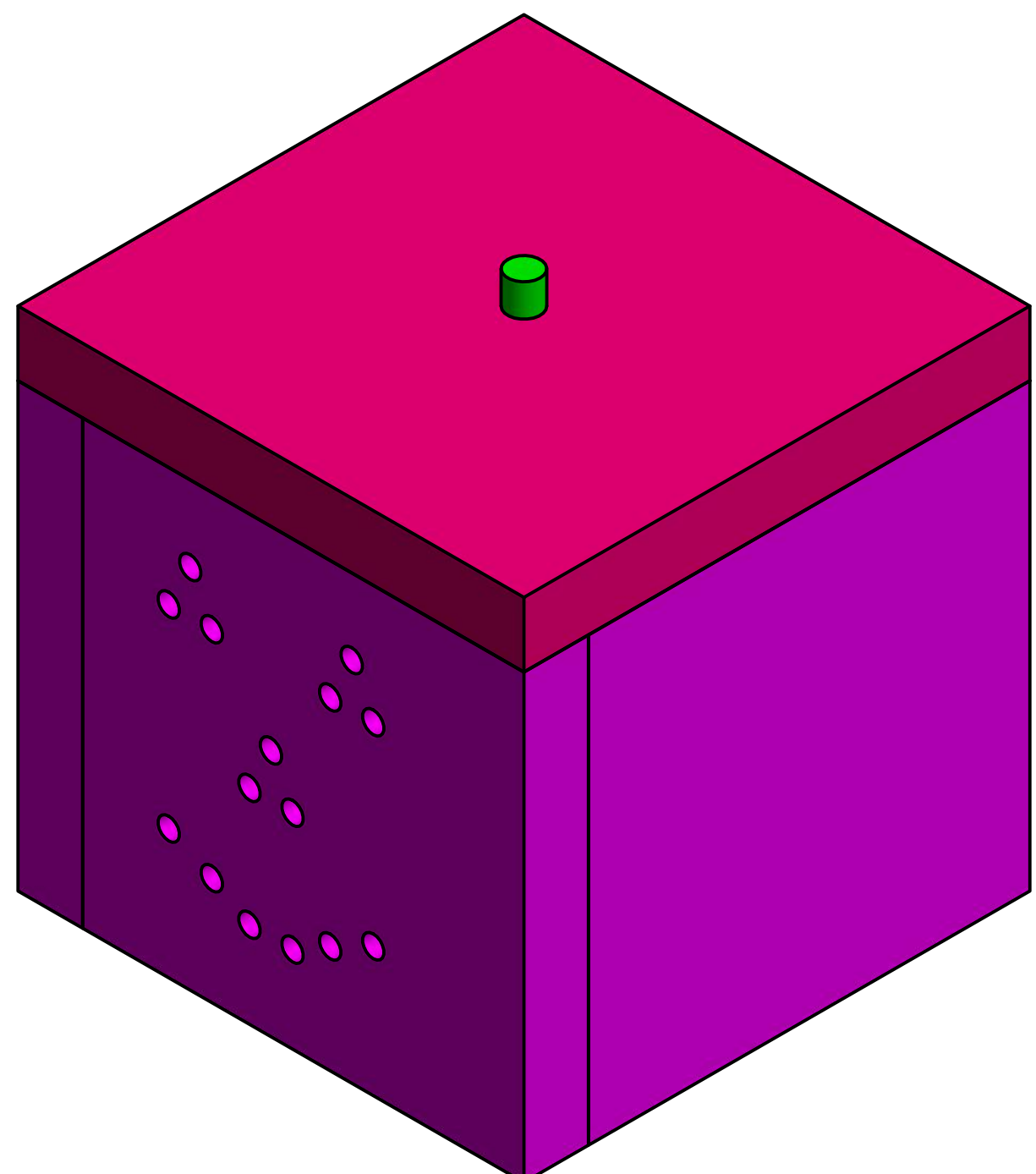

B

B

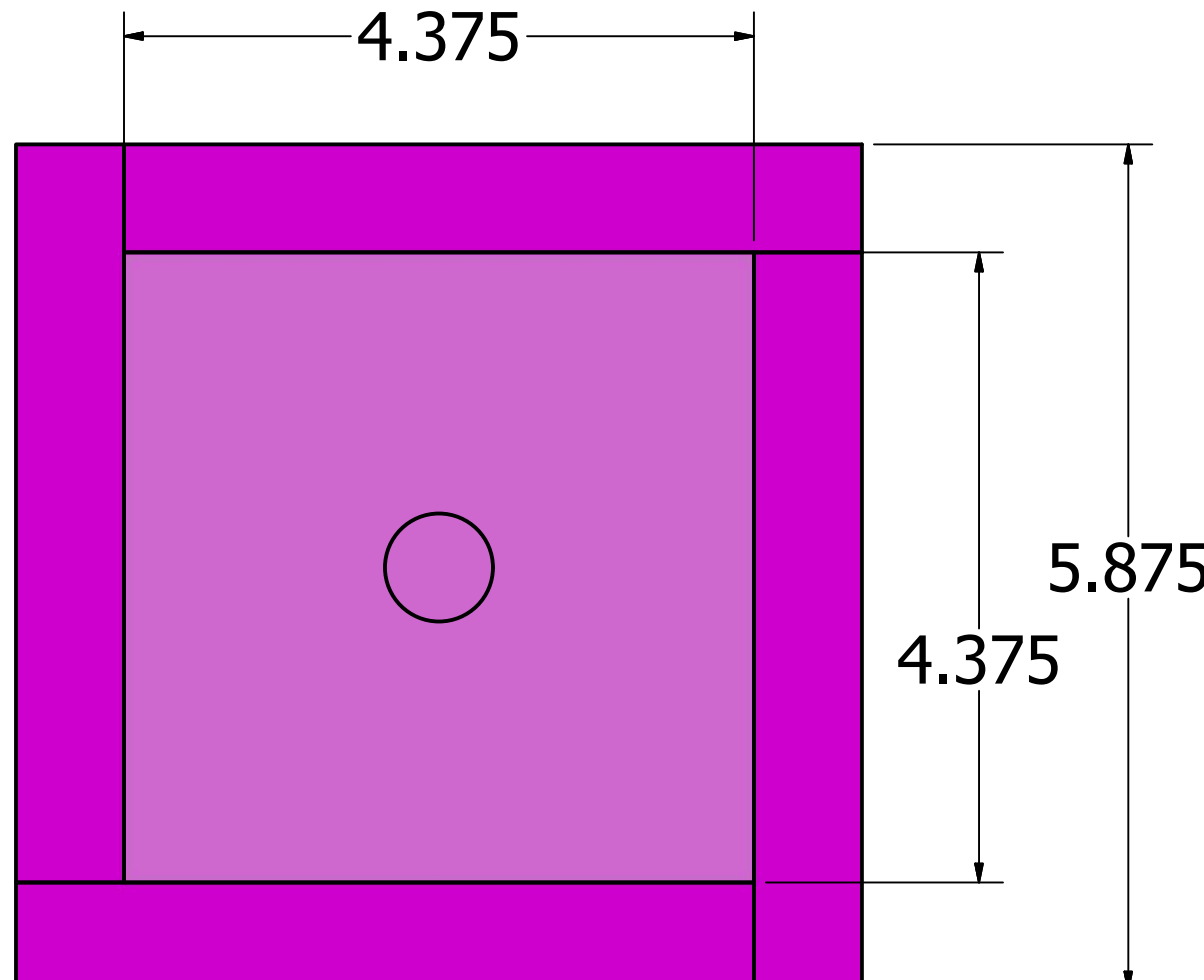

4.375

5.875

4.375

5.875

A

A

4

3

4

2

1

DRAWN	MI	9/5/2015		
CHECKED			TITLE	
QA				
MFG				
APPROVED				
		SIZE	DWG NO	REV
		C	pumpkin_boxes	
		SCALE	SHEET 4 OF 15	

4

3

2

1

D

D

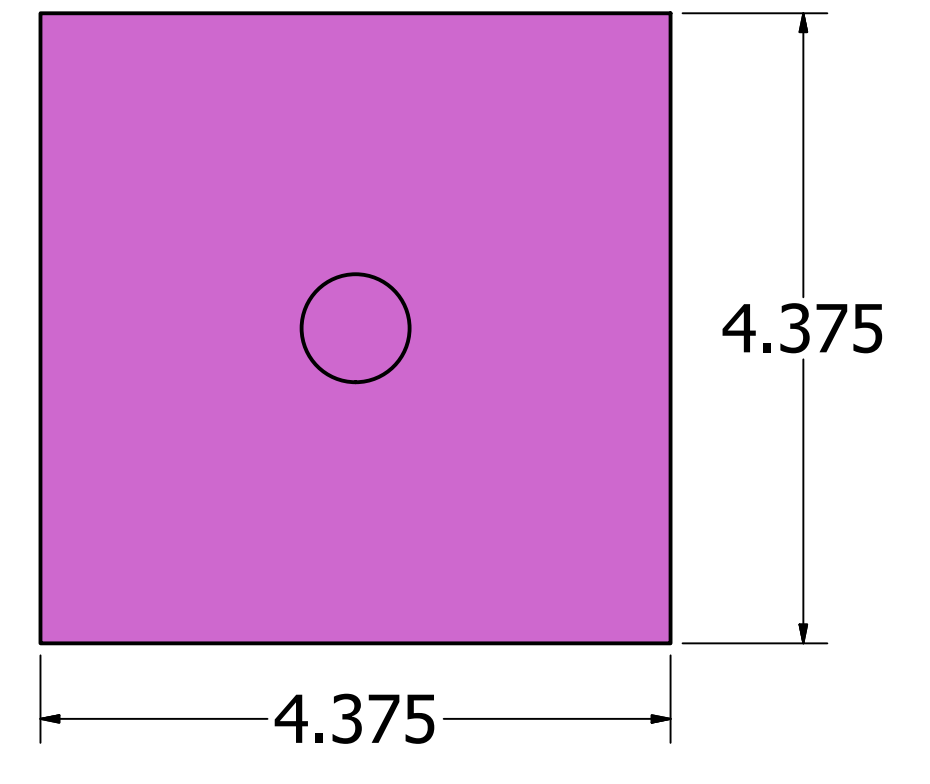
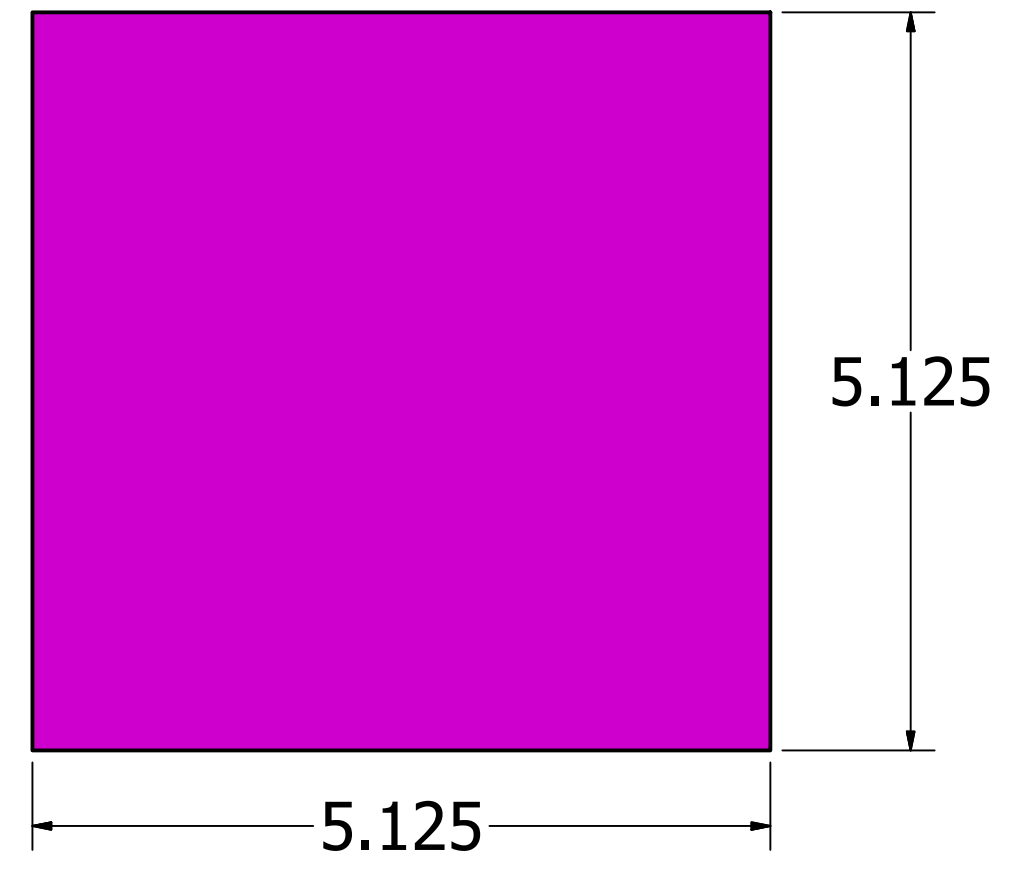
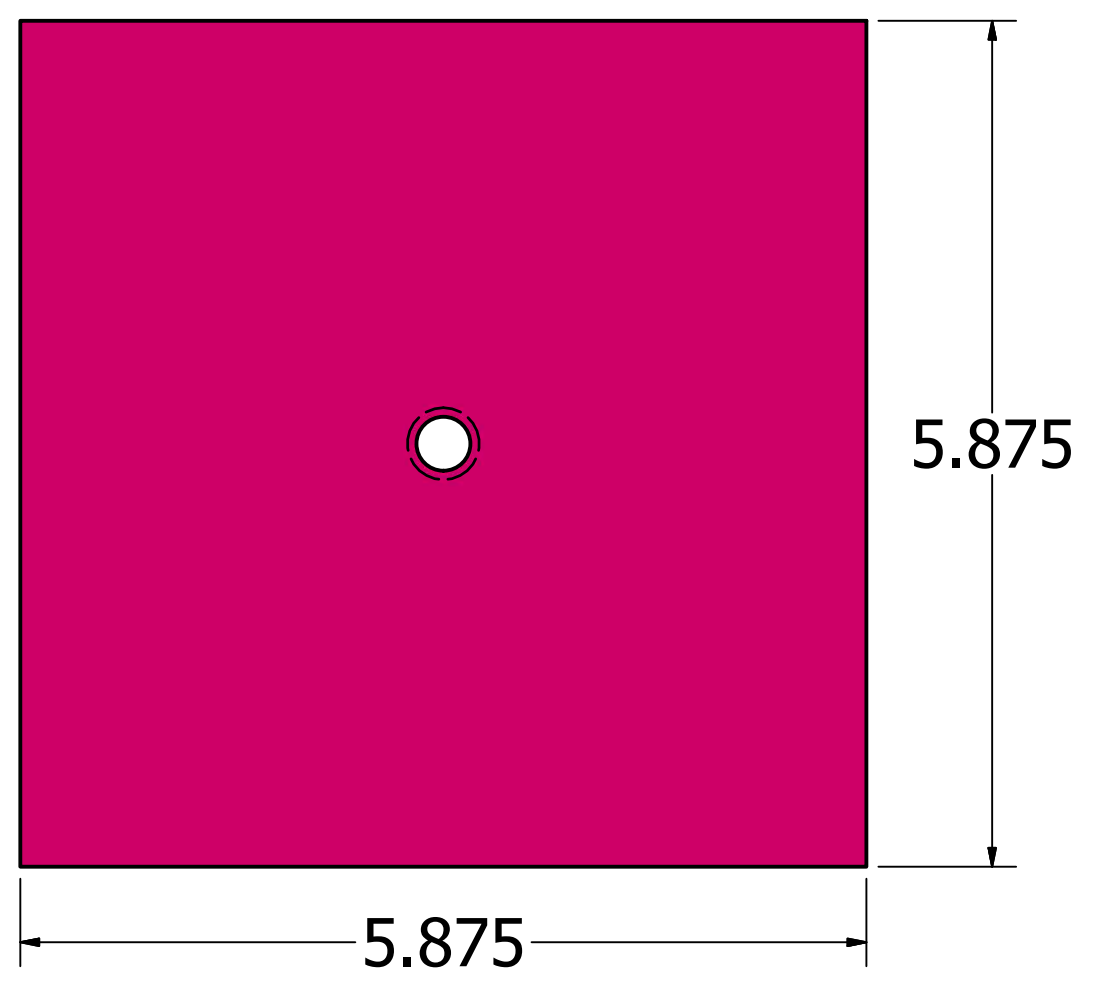
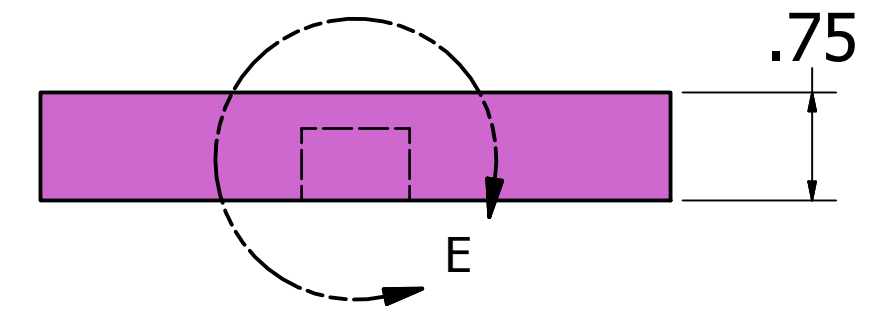
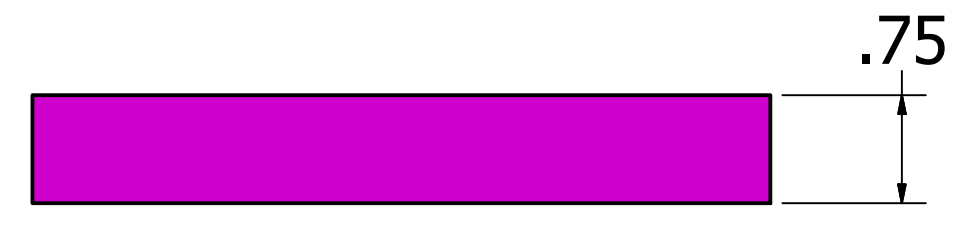
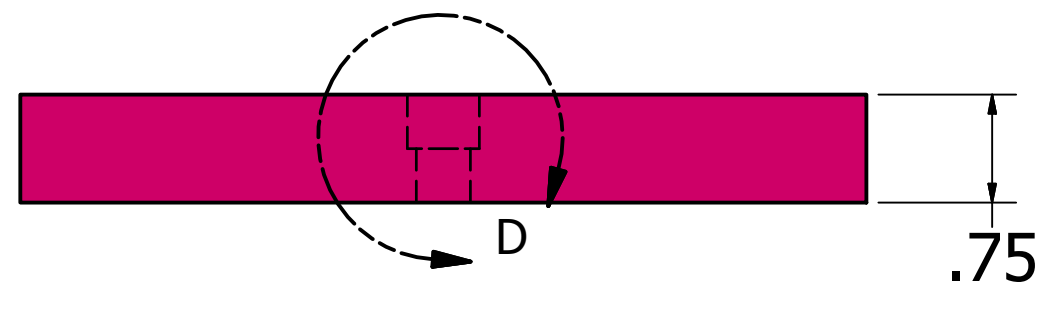

C

C

B

B

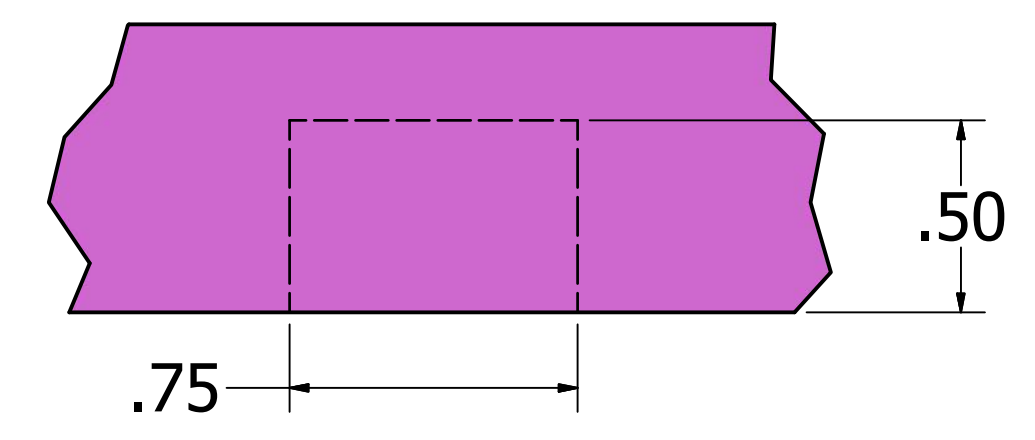
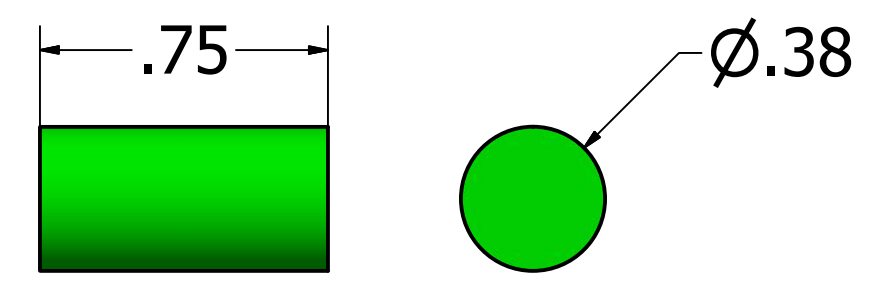
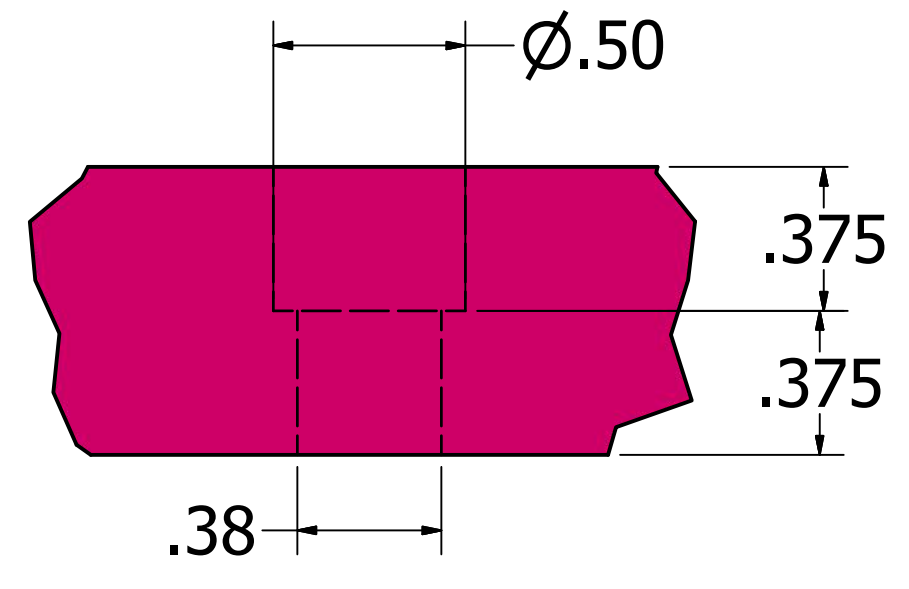

DETAIL D
SCALE 2

DETAIL E
SCALE 2

A

A

DRAWN	MI	9/5/2015		
CHECKED			TITLE	
QA				
MFG				
APPROVED				
			SIZE	DWG NO
			C	pumpkin_boxes
			SCALE	REV
			SHEET	5 OF 15

4

3

4

2

1

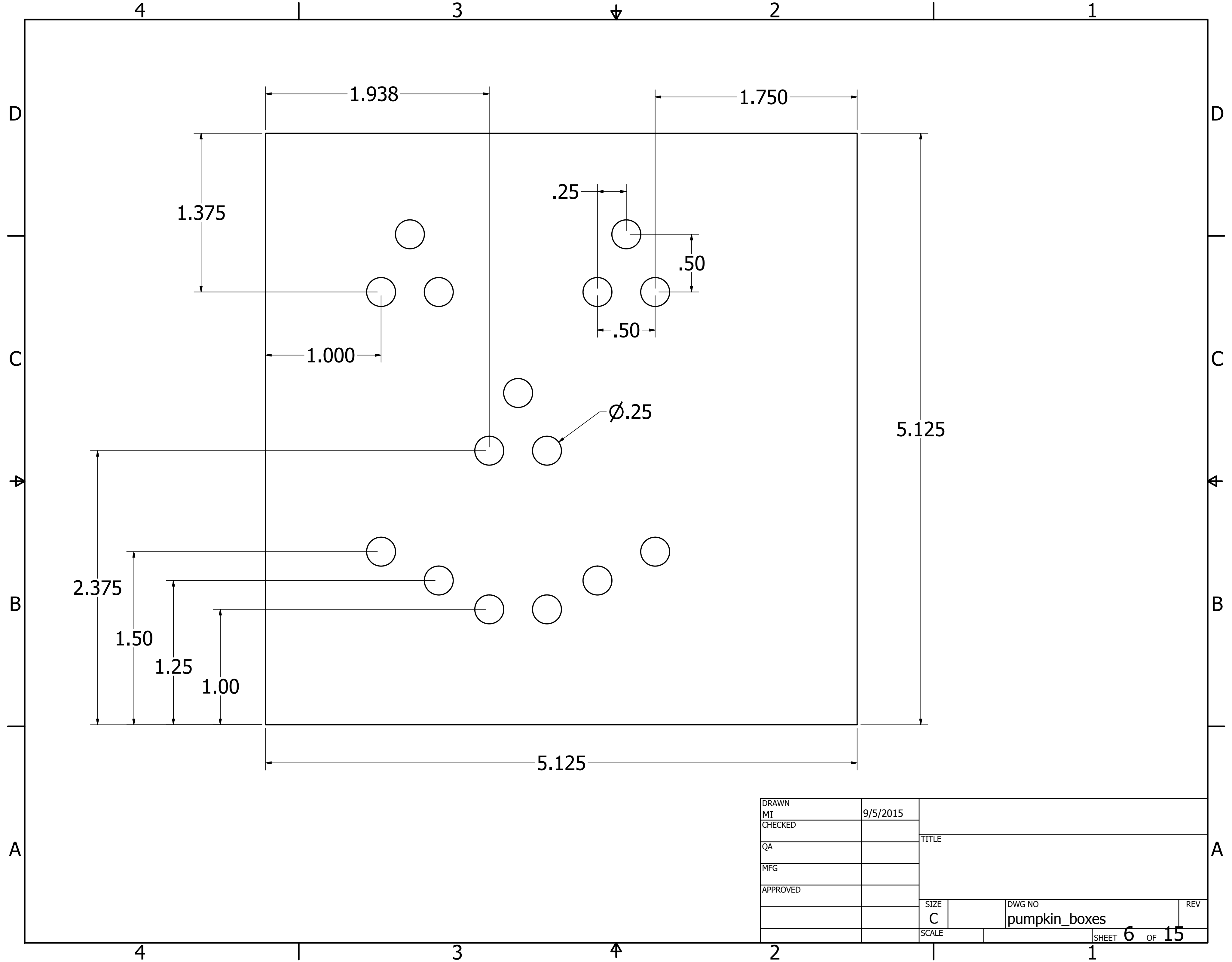

DRAWN	MI	9/5/2015		
CHECKED			TITLE	
QA				
MFG				
APPROVED				
		SIZE	DWG NO	REV
		C	pumpkin_boxes	
		SCALE	SHEET 6 OF 15	

4

3

2

1

D

D

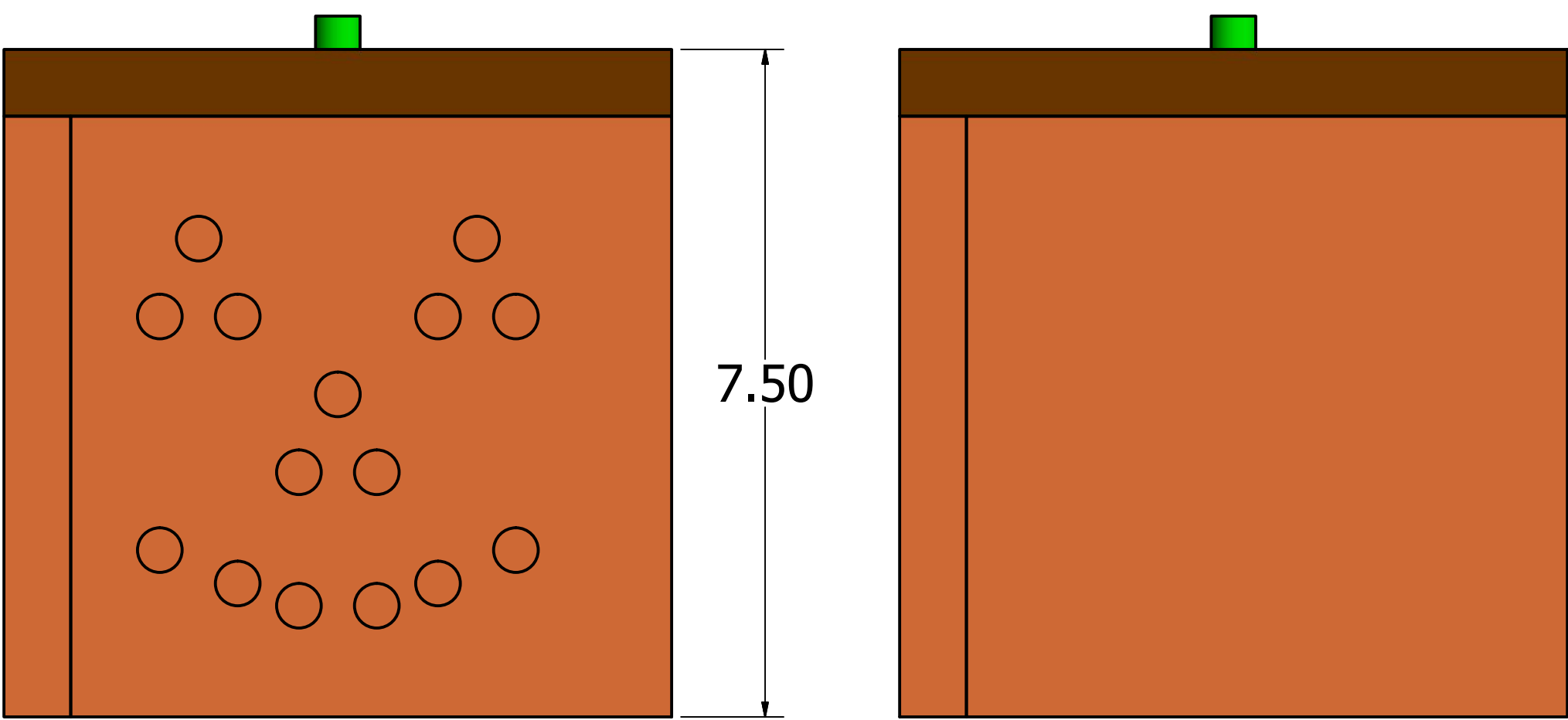

7.50

C

C

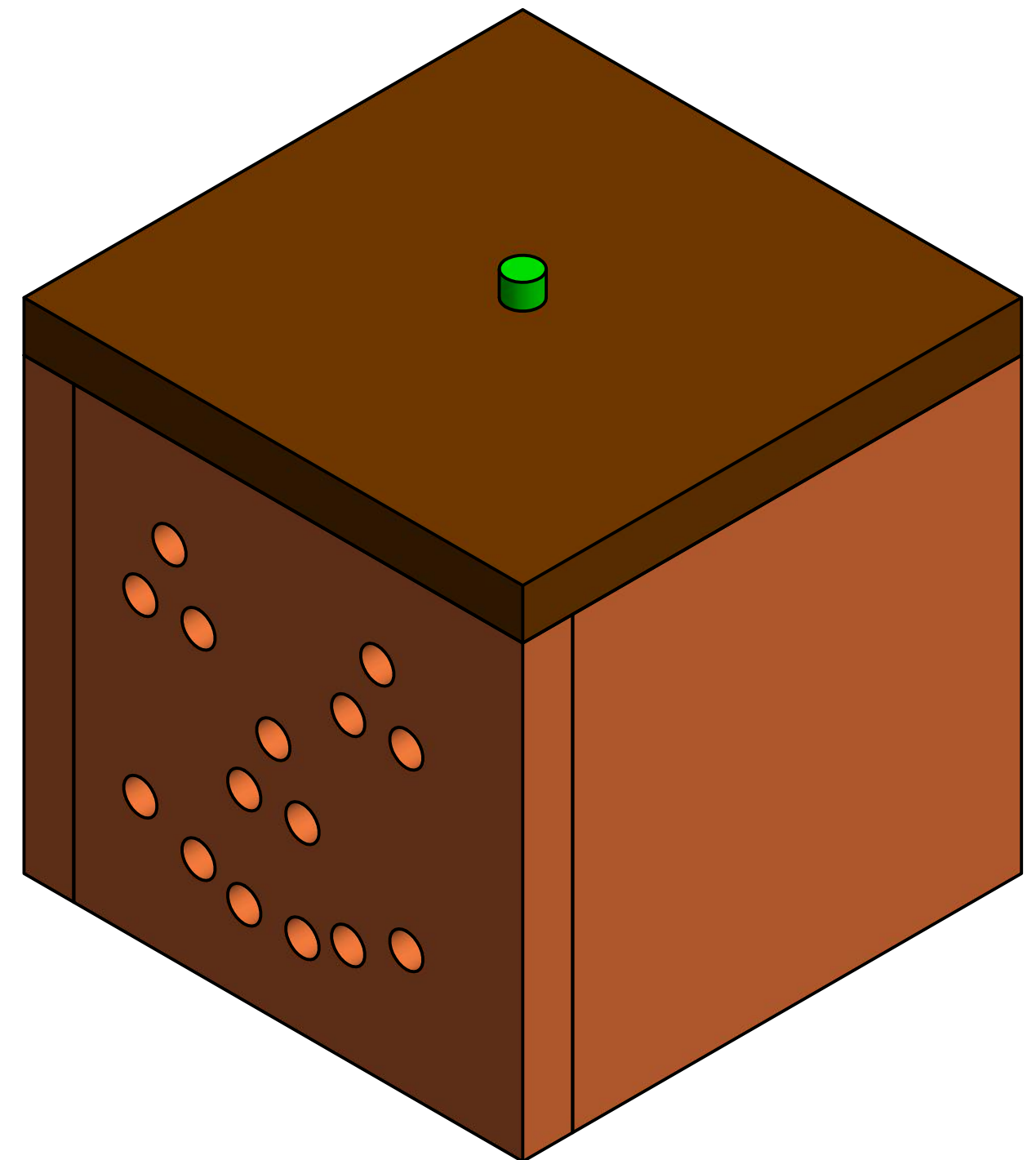

B

B

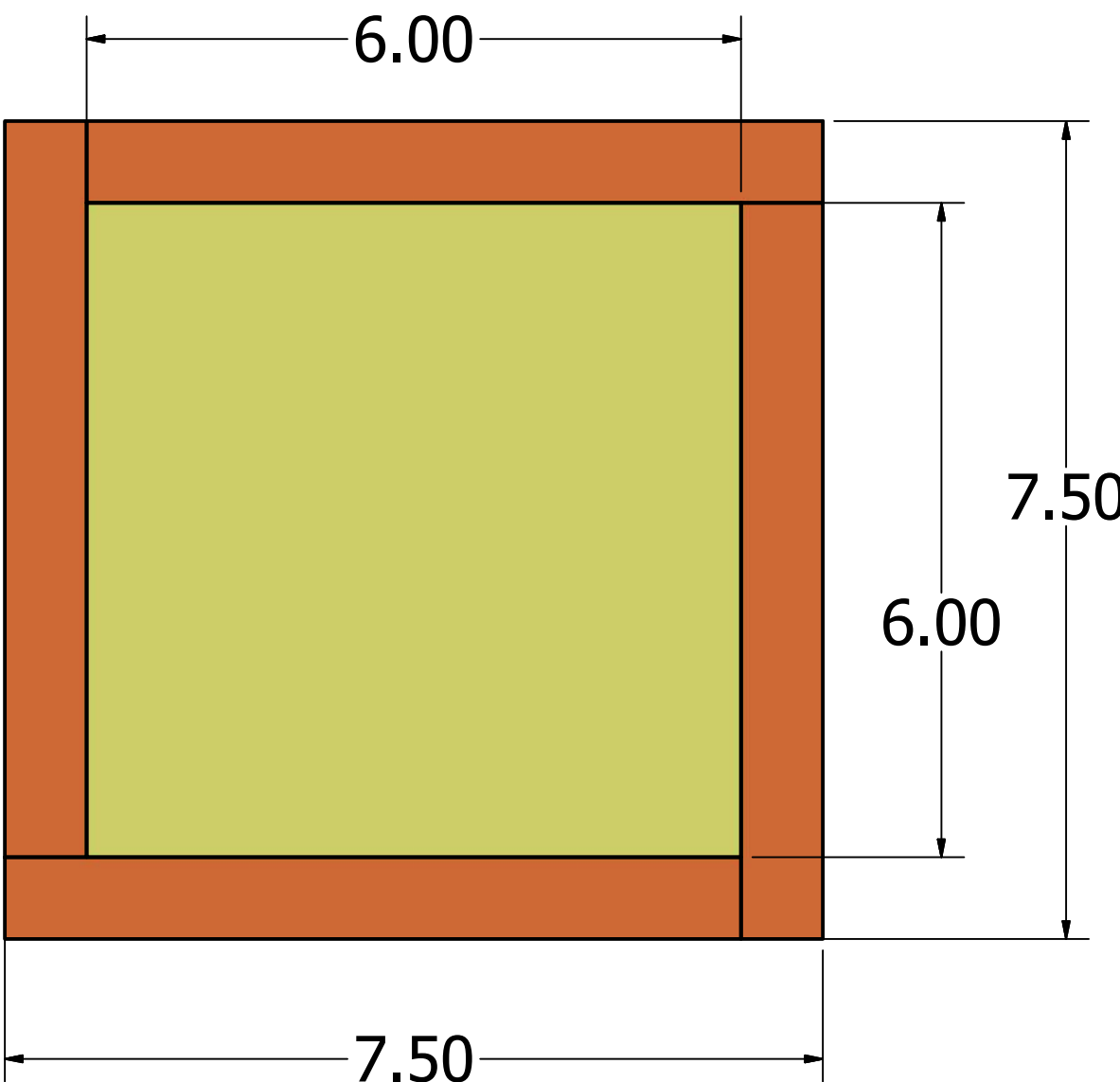

6.00

7.50

6.00

7.50

A

A

A

A

4

3

4

2

1

DRAWN	MI	9/5/2015		
CHECKED			TITLE	
QA				
MFG				
APPROVED				
		SIZE	DWG NO	REV
		C	pumpkin_boxes	
		SCALE	SHEET 7 OF 15	

4

3

2

1

D

D

C

C

B

B

A

A

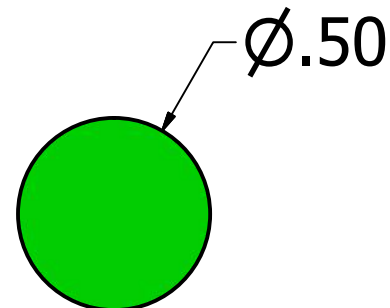
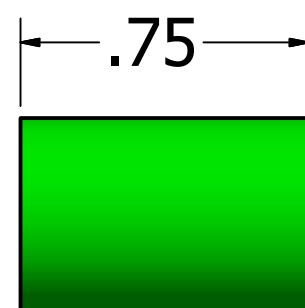
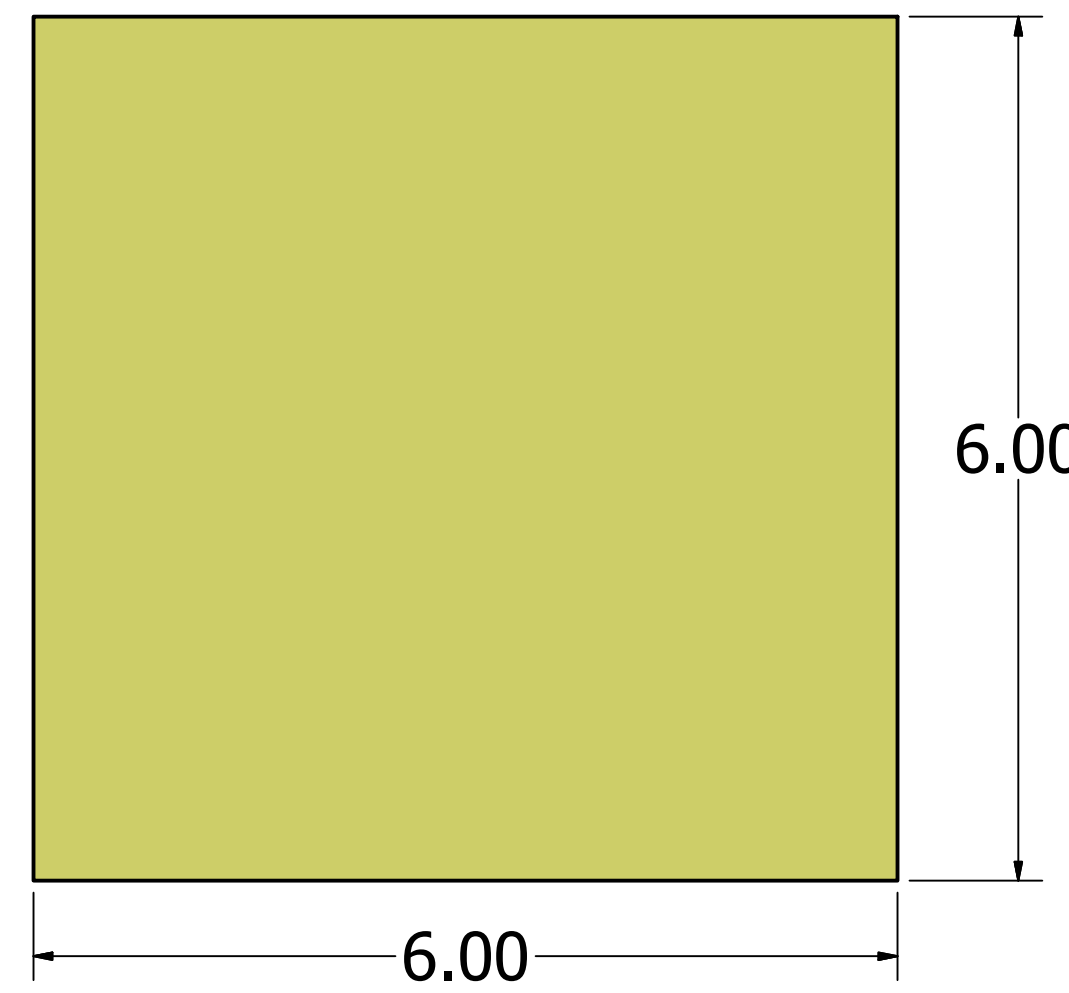
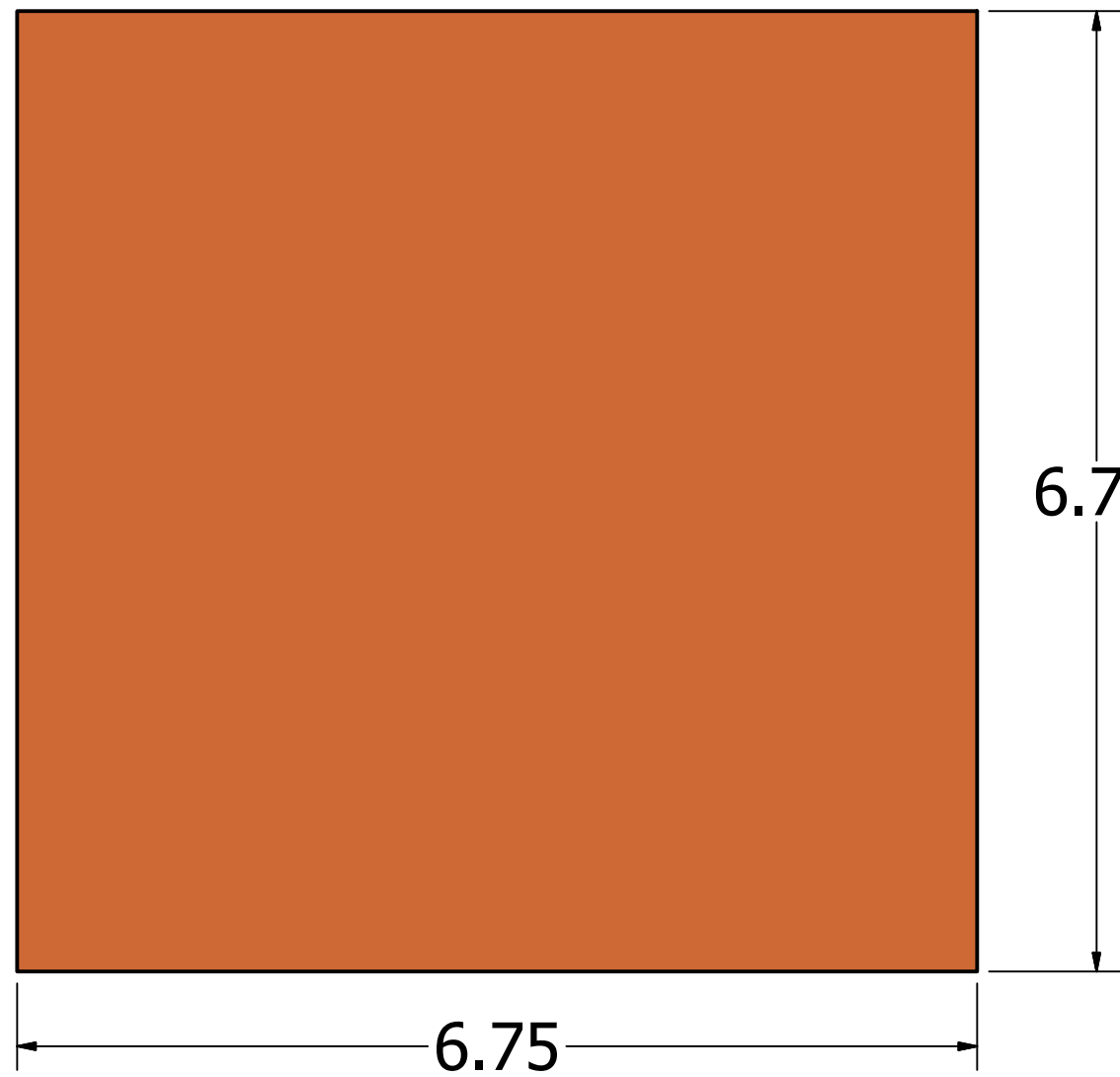
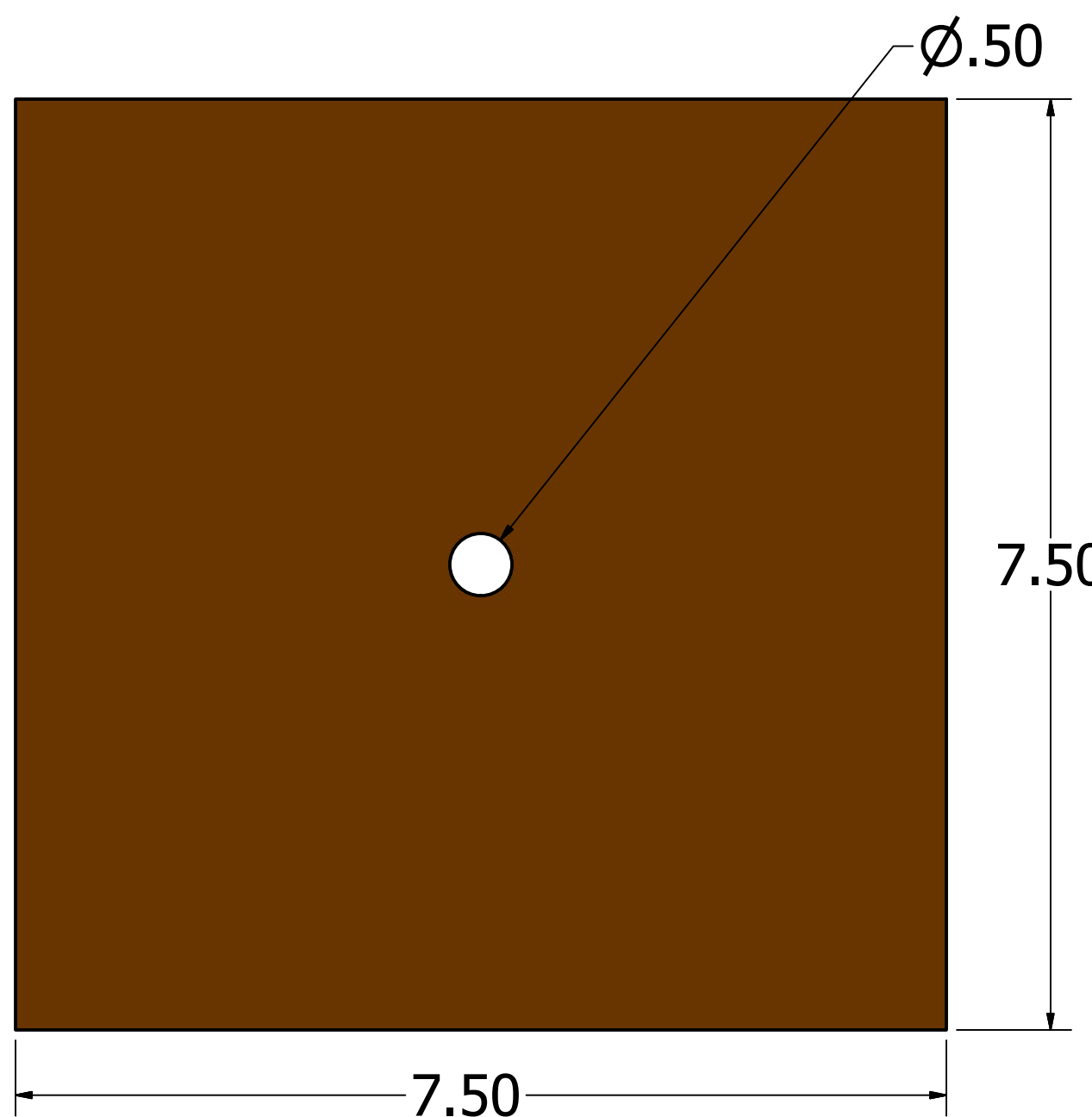

DRAWN	MI	9/5/2015		
CHECKED			TITLE	
QA				
MFG				
APPROVED				
		SIZE	DWG NO	REV
		C	pumpkin_boxes	
		SCALE	SHEET 8 OF 15	

4

3

4

2

1

4 3 2 1

D
C
B
A

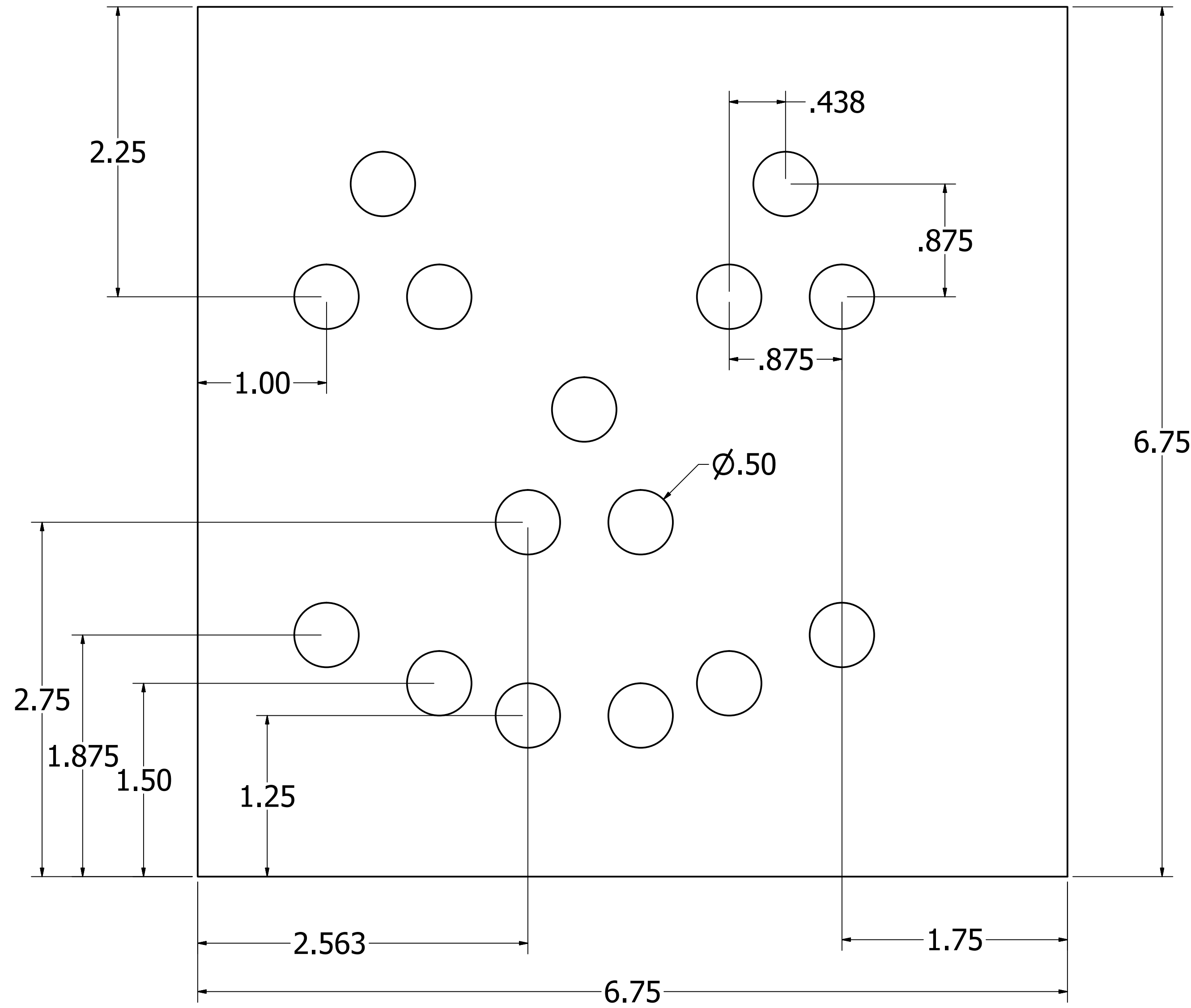

DRAWN	MI	9/5/2015		
CHECKED			TITLE	
QA				
MFG				
APPROVED				
		SIZE	DWG NO	REV
		C	pumpkin_boxes	
		SCALE	SHEET 9	OF 15

4 3 2 1

4

3

2

1

D

D

C

C

B

B

A

A

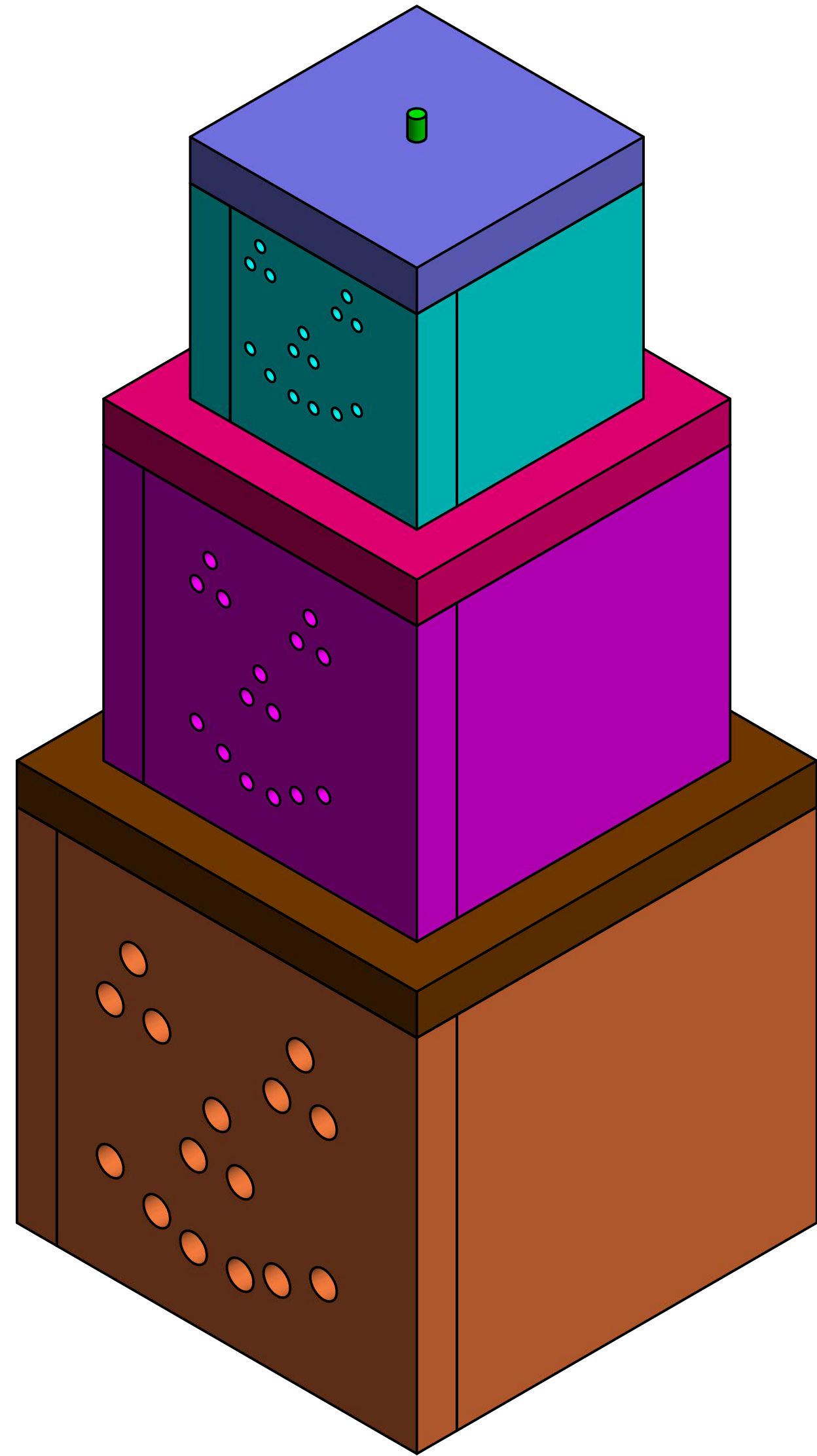
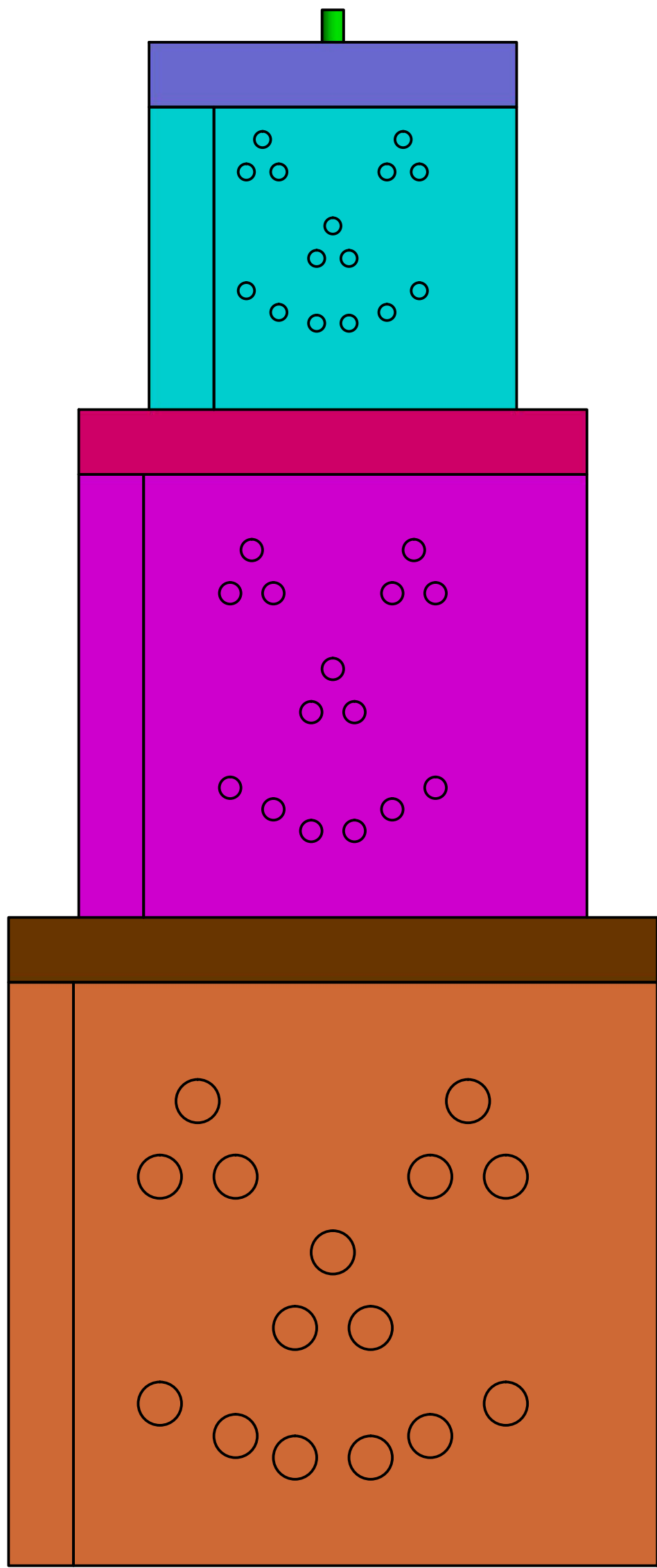

DRAWN	MI	9/5/2015		
CHECKED			TITLE	
QA				
MFG				
APPROVED				
			SIZE	DWG NO
			C	pumpkin_boxes
			SCALE	REV
			SHEET	10 OF 15

4

3

2

1

D

D

C

C

B

B

A

A

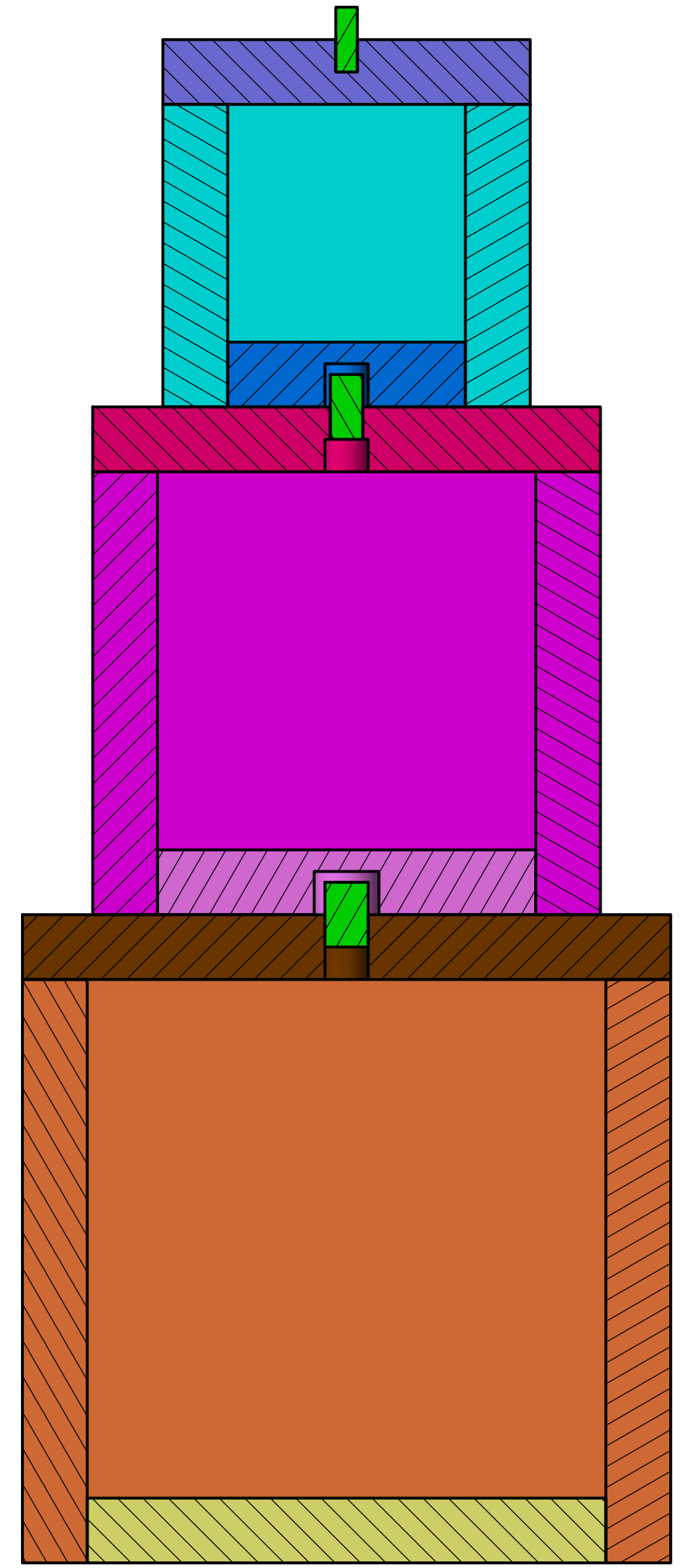
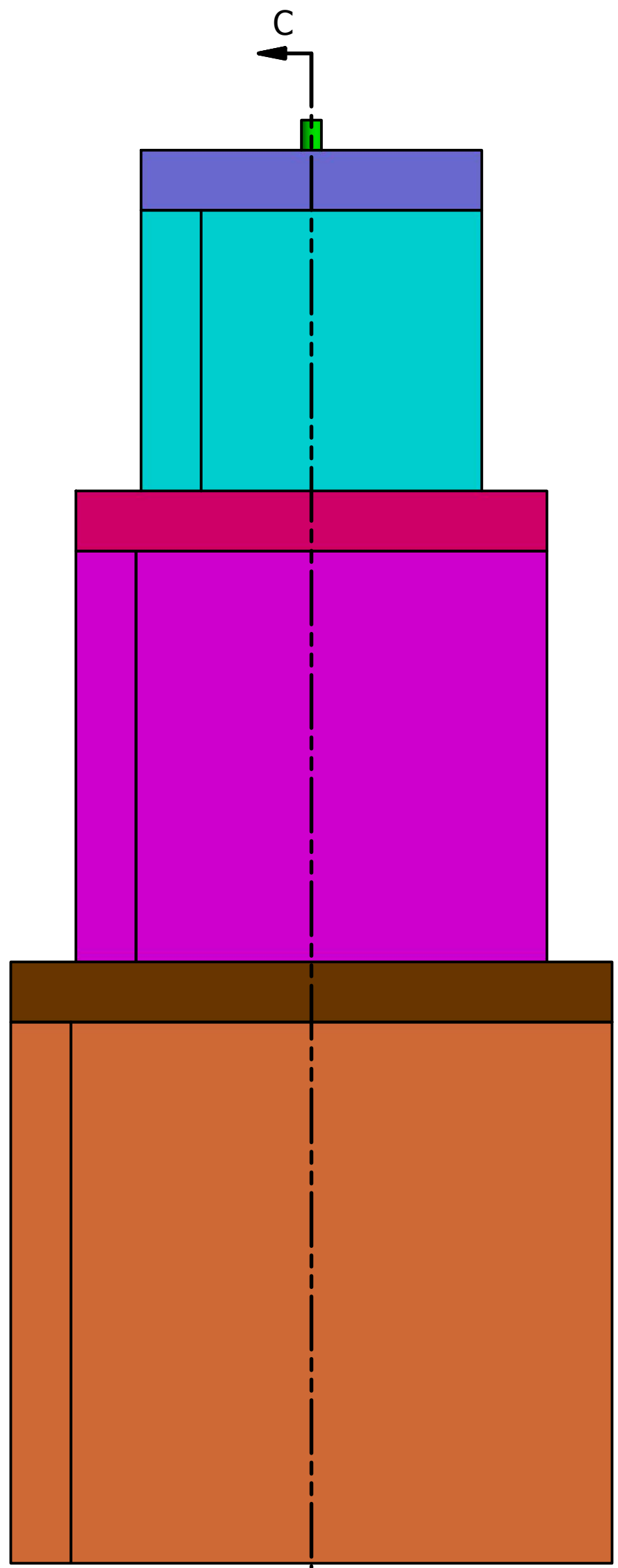

SECTION C-C
SCALE .6

DRAWN	MI	9/5/2015		
CHECKED			TITLE	
QA				
MFG				
APPROVED				
			SIZE	DWG NO
			C	pumpkin_boxes
			SCALE	REV
			SHEET	11 OF 15

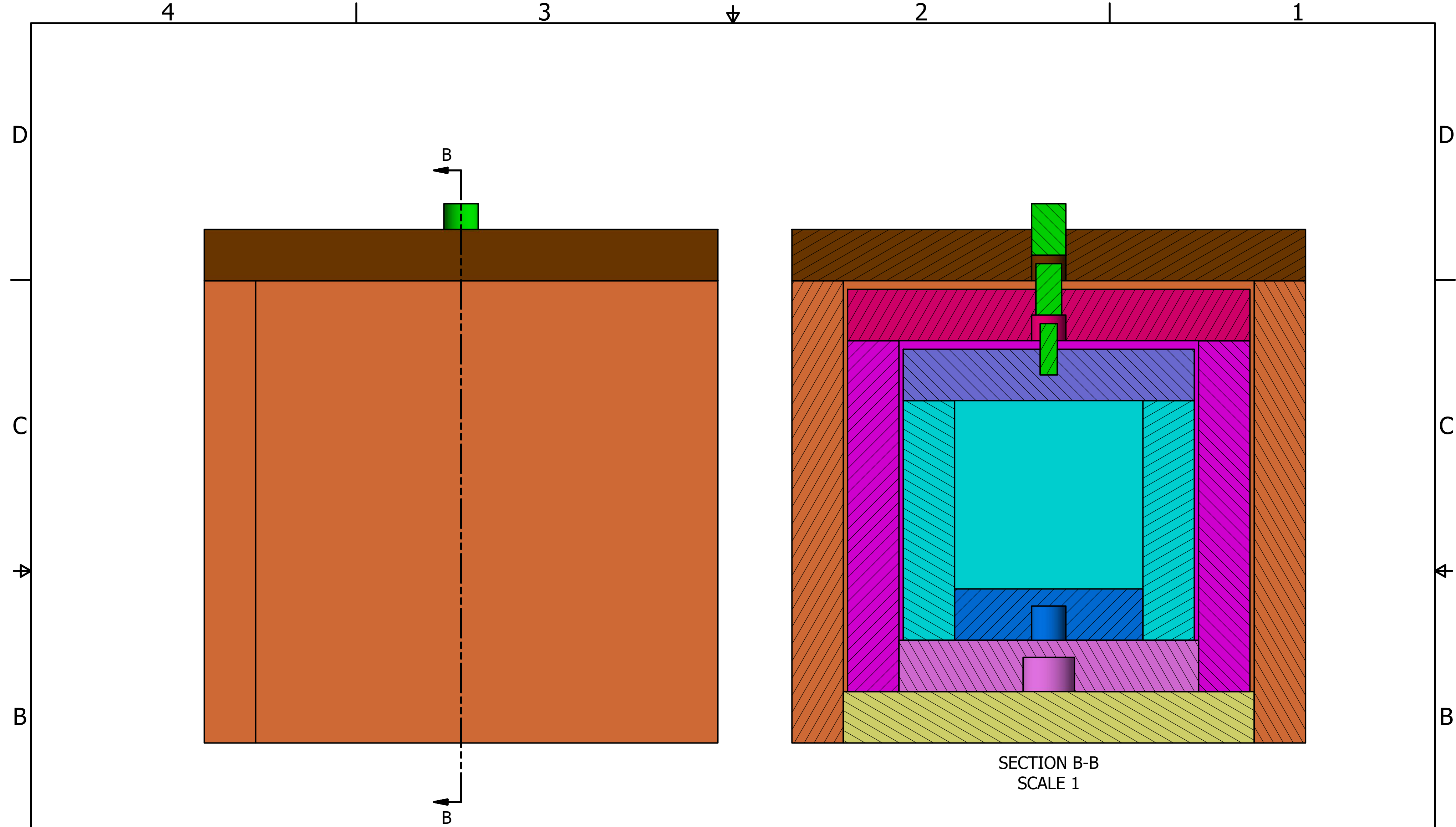

SECTION B-B
SCALE 1

DRAWN	MI	9/5/2015		
CHECKED			TITLE	
QA				
MFG				
APPROVED				
			SIZE	DWG NO
			C	pumpkin_boxes
			SCALE	REV
			SHEET	12 OF 15

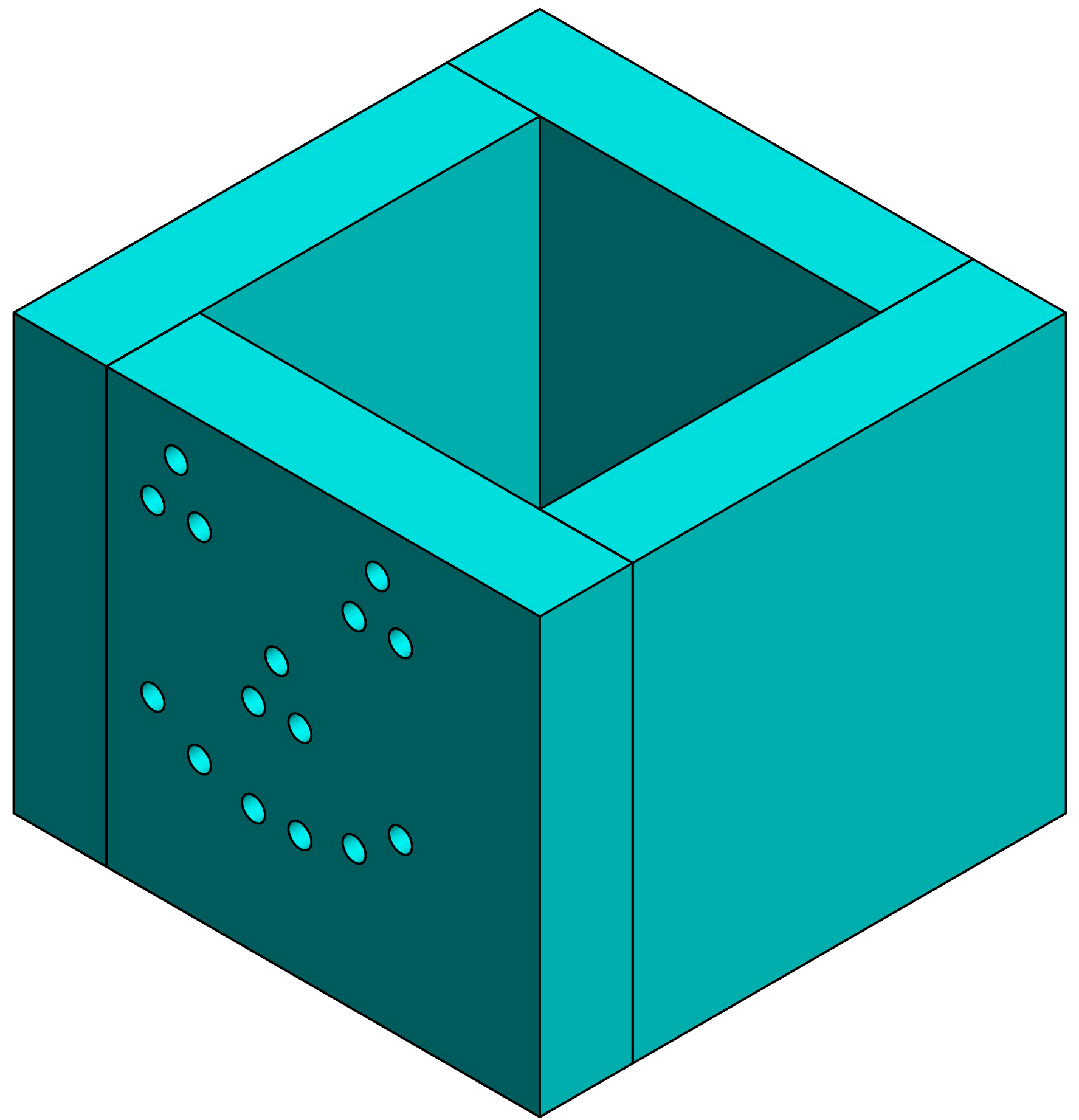
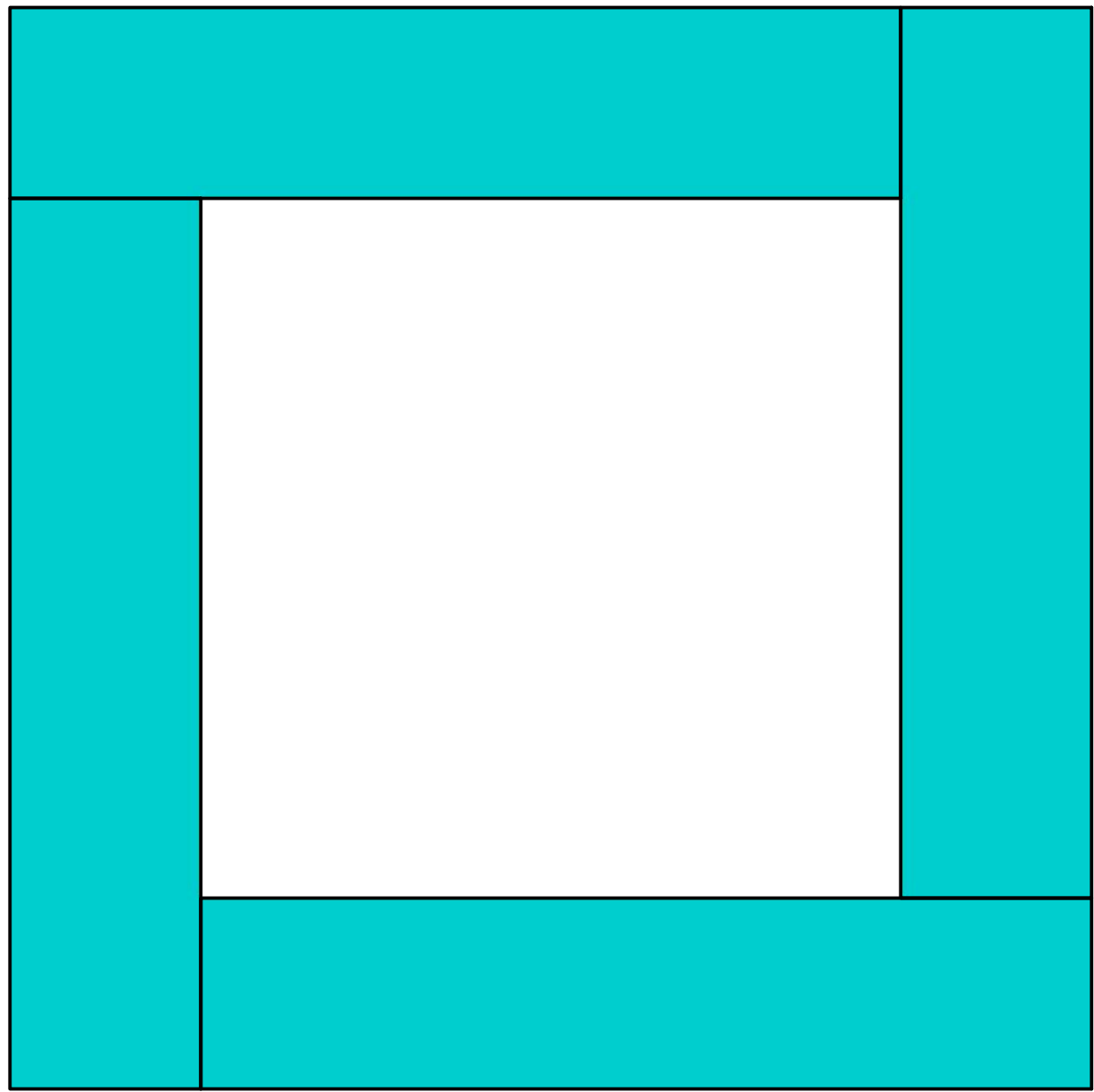

DRAWN	MI	9/5/2015		
CHECKED			TITLE	
QA				
MFG				
APPROVED				
			SIZE	DWG NO
			C	pumpkin_boxes
			SCALE	REV
			SHEET	13 OF 15

4

3

2

1

D

D

C

C

B

B

A

A

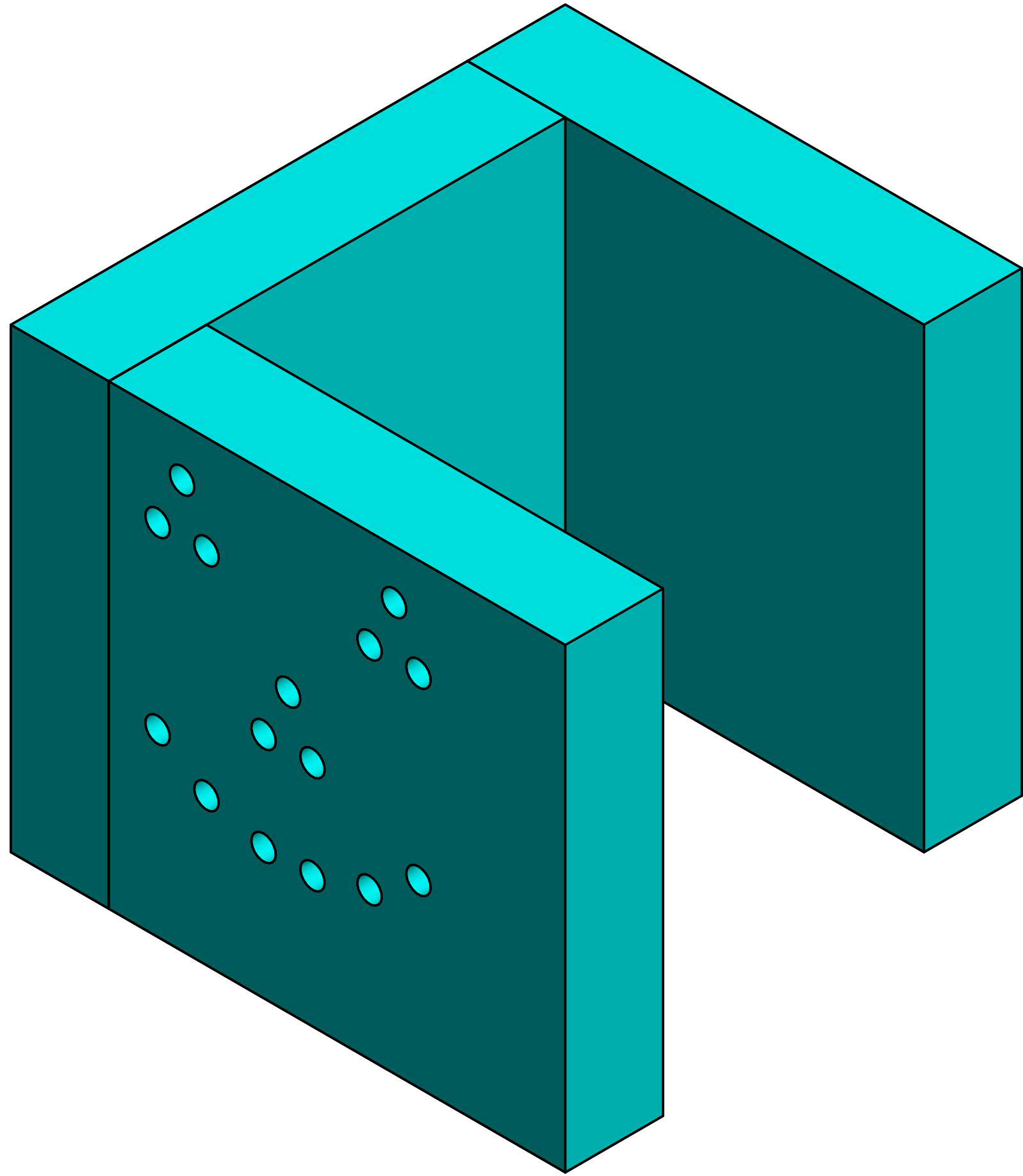
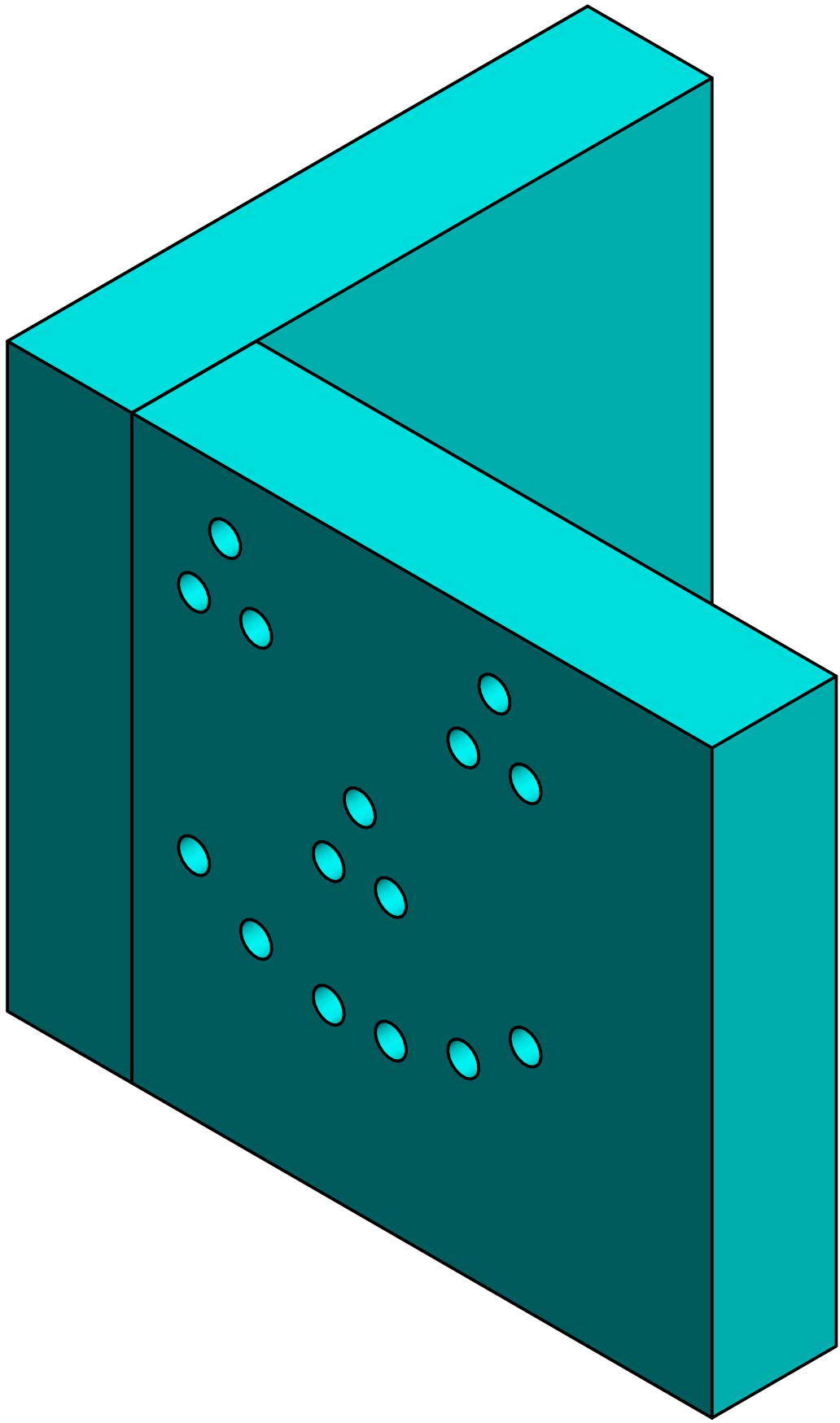

DRAWN	MI	9/5/2015		
CHECKED			TITLE	
QA				
MFG				
APPROVED				
			SIZE	DWG NO
			C	pumpkin_boxes
			SCALE	REV
			SHEET	14 OF 15

4

3

4

2

1

4

3

2

1

D

D

C

C

B

B

A

A

H H

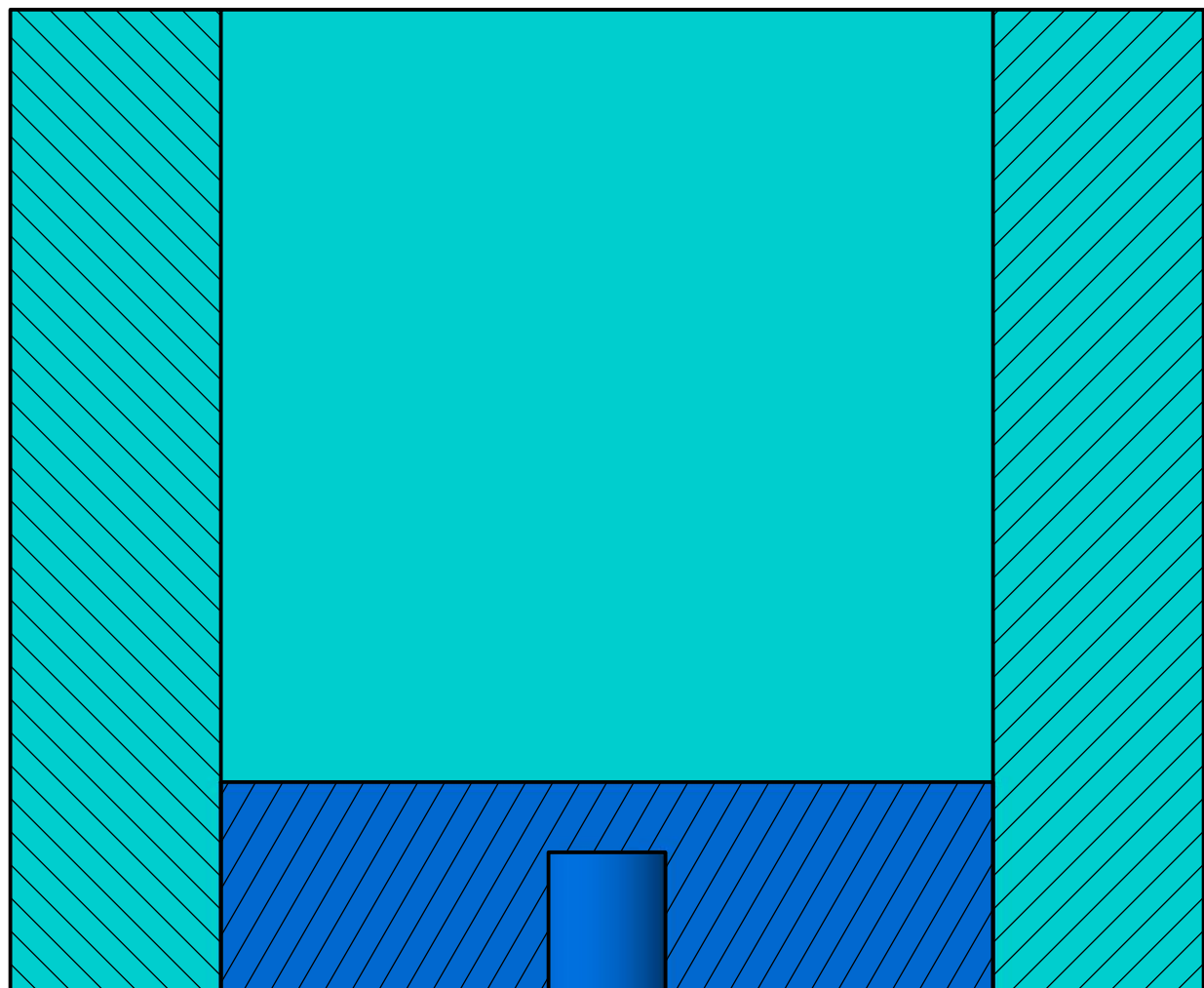
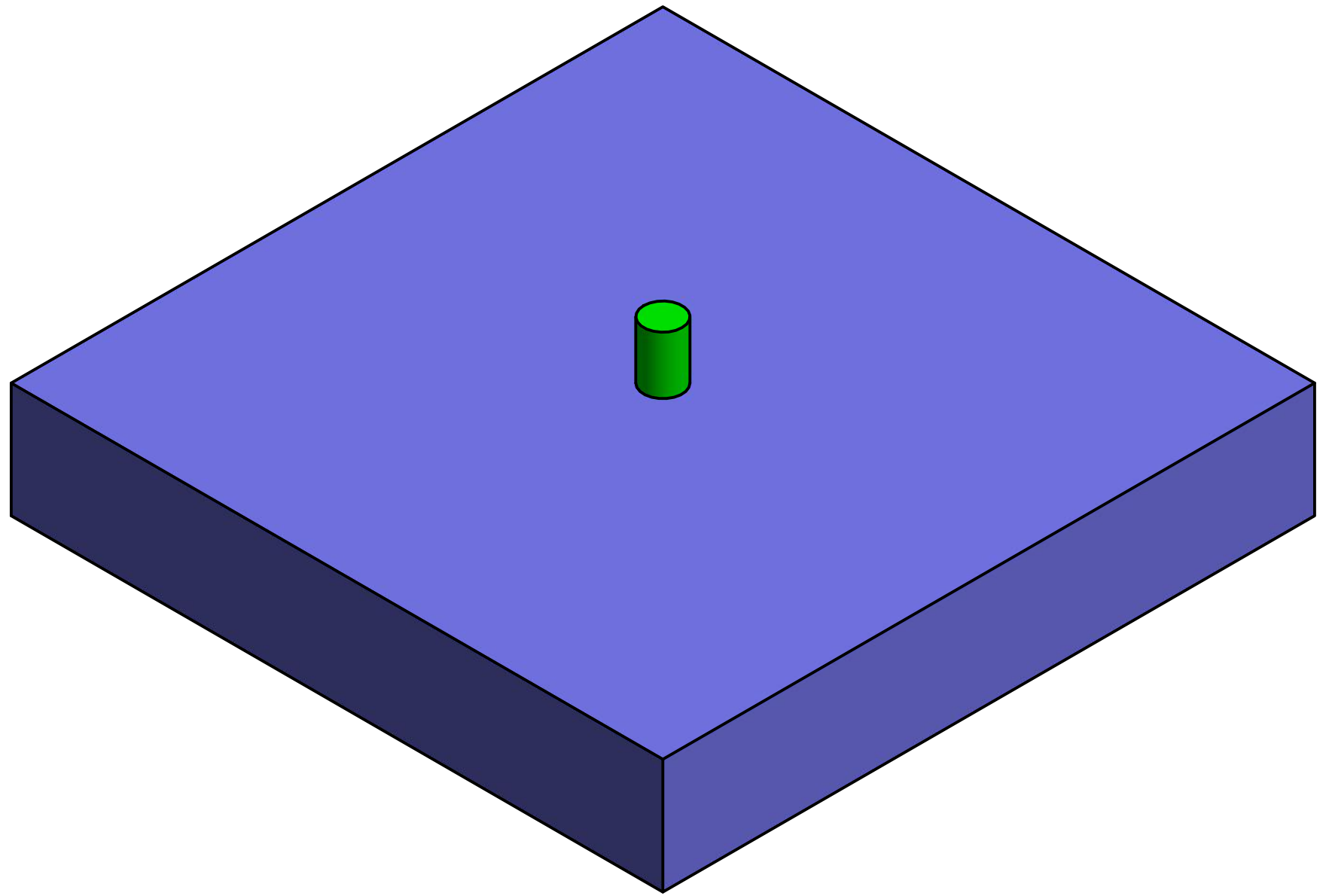
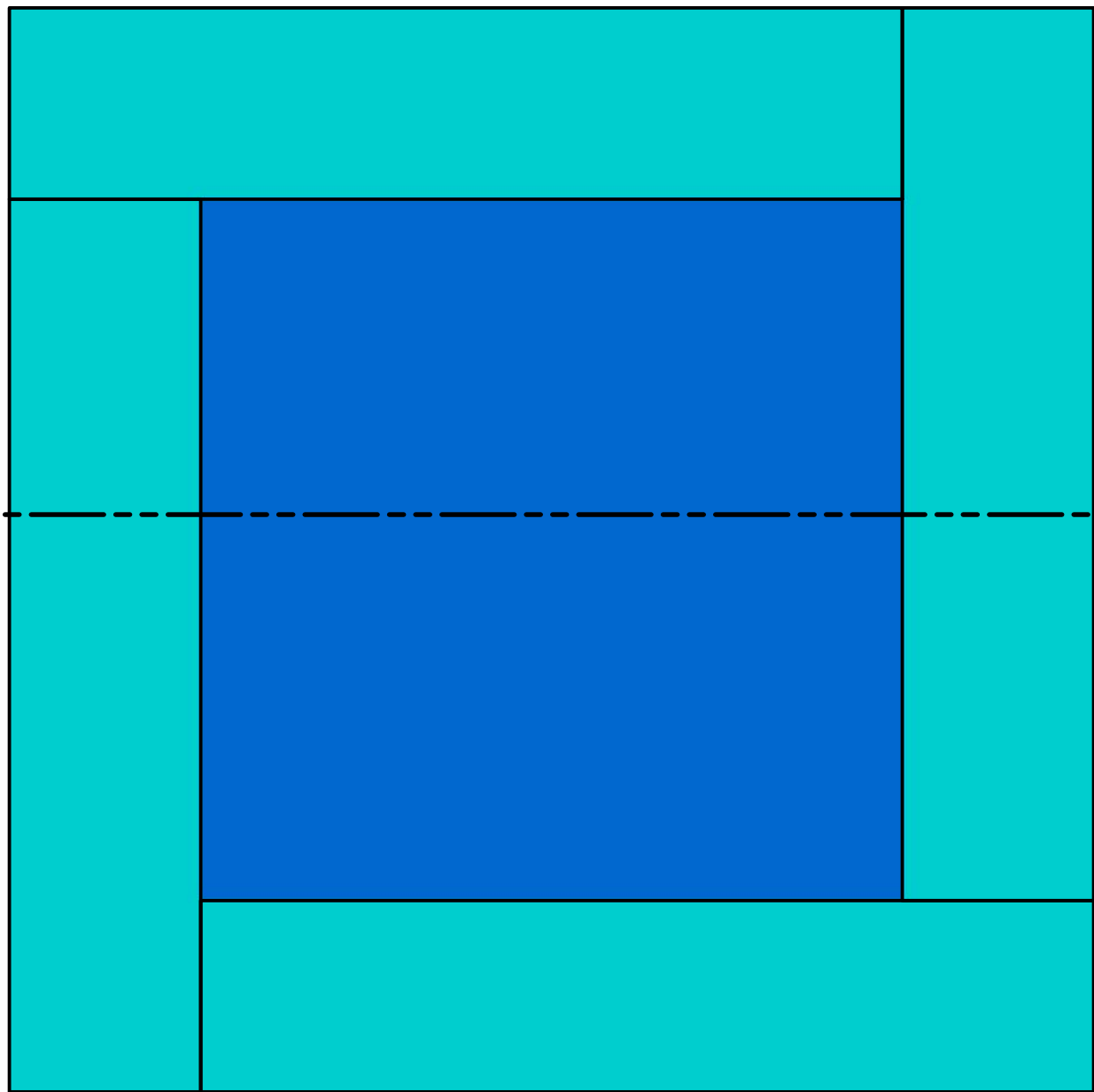

SECTION H-H
SCALE 1.5

DRAWN	MI	9/5/2015		
CHECKED			TITLE	
QA				
MFG				
APPROVED				
			SIZE	DWG NO
			C	pumpkin_boxes
			SCALE	REV
			SHEET	15 OF 15