

Supply 7 - 24Vdc

For supply with 5Vdc
remove 7805 regulator
and bridge pin 1&3

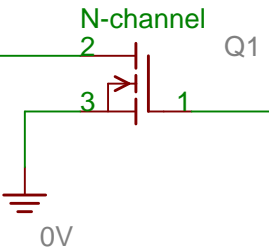
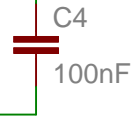
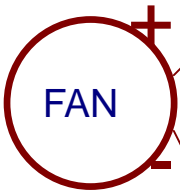
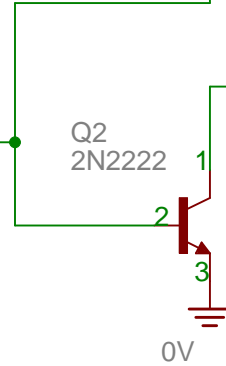
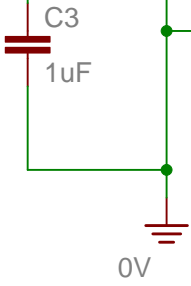
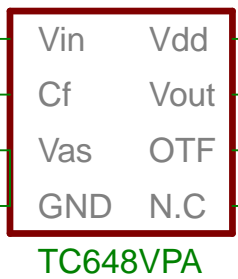
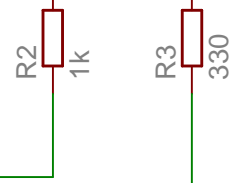
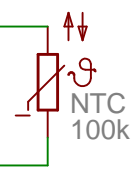
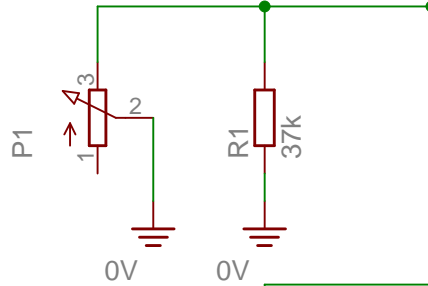
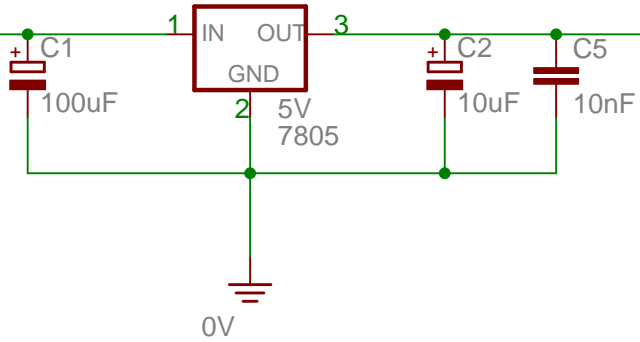
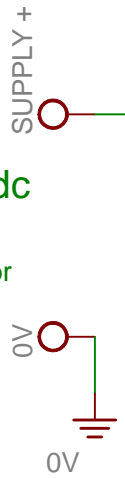

fan voltage = supply voltage